





# SELF-REPAIR HINTS

[bg]	Съвети за ремонт .....	2
[hr]	Savjeti za popravak .....	21
[cs]	Poznámky k opravě .....	40
[da]	Tip til reparation .....	59
[nl]	Reparatie informatie .....	78
[en]	Self-repair hints .....	98
[et]	Remonditeave .....	117
[fi]	Korjausvinkit .....	136
[fr]	Conseils de réparation .....	155
[de]	Reparatur Hinweise .....	174
[el]	Υποδείξεις επισκευής .....	194
[hu]	Javítási útmutató .....	214
[it]	Consigli di riparazione .....	233
[lv]	Informācija par remontu .....	252
[lt]	Informacija apie remontą .....	271
[no]	Reparasjonstips .....	290
[pl]	Wskazówki naprawy .....	309
[pt]	Dicas de resolução .....	329
[ro]	Indicii pentru reparații .....	348
[sk]	Poznámky k opravám .....	368
[sl]	Nasveti za popravilo .....	387
[es]	Consejos de reparación .....	406
[sv]	Reparationsinformation .....	425
[tr]	Onarım İpuçları .....	444

# Съвети за ремонт - Перална машина

 <b>Относно този документ</b> .....	<b>3</b>	4.8 Смяна на уплътнението на вратата.....	15
1.1 Важна информация.....	3	4.8.1 Сваляне на уплътнението на вратата.....	15
1.1.1 Цел.....	3	4.8.2 Монтиране на уплътнението на вратата.....	15
1.2 Обяснение на символите.....	3	4.9 Смяна на ключа на вратата.....	16
1.2.1 Нива на опасност.....	3	4.9.1 Сваляне на ключалката на вратата.....	16
1.2.2 Символи за опасност.....	3	4.9.2 Монтиране на ключалката на вратата.....	17
1.2.3 Структура на предупрежденията.....	4	4.10 Смяна на осветлението на барабана.....	18
1.2.4 Общи символи.....	4	4.10.1 Сваляне на осветлението на барабана.....	18
 <b>Безопасност</b> .....	<b>5</b>	4.10.2 Монтиране на осветлението на барабана.....	18
2.1 Общи инструкции за безопасност.....	5	4.11 Смяна на предния панел.....	19
2.1.1 Всички домашни уреди.....	5	4.11.1 Сваляне на предния панел.....	19
 <b>Инструменти и помощни средства</b> .....	<b>6</b>	4.11.2 Монтиране на предния панел.....	20
 <b>Ремонт</b> .....	<b>7</b>		
4.1 Смяна на горния работен плот.....	7		
4.1.1 Сваляне на горния работен плот.....	7		
4.1.2 Монтиране на горния работен плот.....	7		
4.2 Смяна на чекмеджето за перилен препарат.....	8		
4.2.1 Сваляне на чекмеджето за перилен препарат.....	8		
4.2.2 Монтиране на чекмеджето за перилен препарат.....	8		
4.3 Смяна на дръжката на чекмеджето за перилен препарат.....	9		
4.3.1 Сваляне на дръжката на чекмеджето за перилен препарат.....	9		
4.3.2 Монтиране на дръжката на чекмеджето за перилен препарат.....	9		
4.4 Смяна на фасадния панел.....	10		
4.4.1 Сваляне на фасадния панел.....	10		
4.4.2 Монтиране на фасадния панел.....	11		
4.5 Смяна на вратата.....	12		
4.5.1 Изваждане на вратата.....	12		
4.5.2 Монтиране на вратата.....	12		
4.6 Смяна на компонентите на вратата.....	13		
4.6.1 Сваляне на компонентите на вратата.....	13		
4.6.2 Монтиране на компонентите на вратата.....	13		
4.7 Смяна на капака на помпата.....	14		
4.7.1 Сваляне на капака на помпата.....	14		
4.7.2 Монтиране на капака на помпата.....	14		

# **i** Относно този документ

## 1.1 Важна информация

### 1.1.1 Цел

Тези съвети за ремонт помагат на потребителя да ремонтира сам уреди в съответствие с регламента за екологосъобразно проектиране на уредите (от 03.2021 г.).

Те съдържат информация как да сменят определени резервни части, включително предупреждения и рискове.

Ако имате някакви въпроси, моля свържете се с нашия отдел за обслужване на клиенти. Носим отговорност за щети, само ако съветите за ремонт са спазени правилно.

## 1.2 Обяснение на символите

### 1.2.1 Нива на опасност

Предупредителните нива се състоят от символ и сигнална дума. Сигналната дума показва сериозността на опасността.





Ниво на предупреждение	Значение
	Неспазването на предупредителното съобщение ще доведе до смърт или сериозни наранявания.
	Неспазването на предупредителното съобщение може да доведе до смърт или сериозни наранявания.
	Неспазването на предупредителното съобщение може да доведе до леки наранявания.
	Неспазването на предупредителното съобщение може да доведе до имуществени щети.

Таблица 1: Нива на опасност

### 1.2.2 Символи за опасност

Символите за опасност са символични изображения, които дават индикация за вида опасност.

В този документ се използват следните символи за опасност:

Символ за опасност	Значение
	Общо предупредително съобщение
	Опасност от електрическо напрежение
	Риск от експлозия
	Опасност от порязвания

## **i** Относно този документ





Символ за опасност	Значение
	Опасност от премазване
	Опасност от горещи повърхности
	Опасност от силно магнитно поле
	Опасност от нейонизиращо лъчение

Таблица 2: Символи за опасност

### 1.2.3 Структура на предупрежденията

Предупрежденията в този документ имат стандартизиран външен вид и стандартизирана структура.

	<p><b>ОПАСНОСТ</b></p> <p><b>Вид и източник на опасността!</b>          Възможни последици от игнориране на опасността/предупреждението.</p> <ul style="list-style-type: none"> <li>▶ Мерки и забрани за предотвратяване на опасността.</li> </ul>
--	--

Следният пример показва предупреждение, което уведомява за токов удар, предизвикан от части под напрежение. Споменава се мярката за избягване на опасността.

	<p><b>ОПАСНОСТ</b></p> <p><b>Риск от токов удар поради части под напрежение!</b>          Смърт от токов удар</p> <ul style="list-style-type: none"> <li>▶ Изключете уредите от електрическото захранване поне 60 секунди преди започване на ремонта.</li> </ul>
--	--

### 1.2.4 Общи символи

В този документ се използват следните общи символи:







Общ символ	Значение
	Идентифициране на специален съвет (текст и/или графика)
	Идентифициране на прост съвет (само текст)
	Идентифициране на връзка към видео урок
	Идентифициране на необходимите инструменти
	Идентифициране на необходимите предварителни условия
	Идентифициране на условие (ако ..., тогава ...)
	Идентифициране на резултат
Старт	Идентифициране на ключ или бутон
[00123456]	Идентифициране на каталожен номер
Статус	Идентифициране на показания текст/прозорец (на дисплея на уреда)

Таблица 3: Общи символи

## **2.1 Общи инструкции за безопасност**

### **2.1.1 Всички домашни уреди**

#### **Риск от токов удар поради части под напрежение!**

- Грешки при ремонти, включващи електрически компоненти, могат да доведат до токов удар!
- Разкачете уреда от електрическата мрежа за поне 60 секунди, преди да започнете работа.
- След ремонта трябва да се извърши проверка за безопасност съгласно VDE 0701 или в съответствие със специфичните за страната разпоредби.

#### **Риск от нараняване от остри ръбове!**

- Носете предпазни ръкавици.

#### **Риск от премазване по време на ремонт, поддръжка, отстраняване на неизправности и сервиз поради тежки и движещи се компоненти**

- Носете защитни обувки.
- Закрепете тежките компоненти, така че да не паднат.
- Не позволявайте контакт на части от тялото с движещи се компоненти.







#### **Риск за безопасността/функцията на уреда!**

- Използвайте само оригинални резервни части.

#### **Риск от повреда на електростатично чувствителни компоненти (ESD)!**

- Не докосвайте модулите, включително връзки и проводникови пътища.

## Инструменти и помощни средства

посочване	Подробности	Изображения
Помощен инструмент [15000155]	Инструмент за разхлабване на пластмасови части	
Отвертка Torx T20 с отвор [00340764]	100 мм, за винтове с предпазен щифт	
Динамометричен ключ [15000441]	Динамометричен ключ 20 - 100 Nm	
Плоска отвертка [00340854]	Врх 3,5 mm x 0,6 mm x 100 mm, Защитна изолация 1000 V AC	
Плоска отвертка [00340855]	Врх 5,5 mm x 1,0 mm x 125 mm, Защитна изолация 1000 V AC	
Клещи с игловидни челюсти, под ъгъл [00341269]	Дължина 200 мм	
Клещи резачки [00342182]	Дължина: 200 мм	



посочване	Подробности	Изображения
Комбиниран ключ [00340811]	гаечния ключ 10°mm, M6	
Combination wrench [00340814]	гаечния ключ 13°mm, M8	
Комбиниран ключ [00340817]	гаечния ключ 17 mm, M10	
Комбиниран ключ [15000459]	гаечния ключ 16°mm, M10	

## 4.1 Смяна на горния работен плот

### Специални инструменти:

-  Накрайник Torx TX20 с отвор Дължина 152 mm, използваема [00341272]  
дължина 124 mm, 1/4" шестостенна  
отвертка (6,35 mm), за винтове с  
предпазен щифт

### Изискване:

-  Уредът е изключен от захранването.
-  Уредът е изключен от водоснабдителната мрежа.

### 4.1.1 Сваляне на горния работен плот

- ▶ 1. Свалете винтовете (1).
- 2. Избутайте горния работен плот към задния край на уреда (2).
- 3. Преместете горния работен плот нагоре (3), за да го свалите.

### 4.1.2 Монтиране на горния работен плот



Следете изолацията на кабела. Кабелът може да е захванат.

- ▶ Монтирайте в обратен ред.

## 4.2 Смяна на чекмеджето за перилен препарат

### Изискване:

- ✓ Уредът е изключен от захранването.
- ✓ Уредът е изключен от водоснабдителната мрежа.

### 4.2.1 Сваляне на чекмеджето за перилен препарат

1. Изтеглете чекмеджето за перилен препарат.
2. 1. Натиснете надолу върху подложката (1).  
2. Свалете чекмеджето за перилен препарат (2).

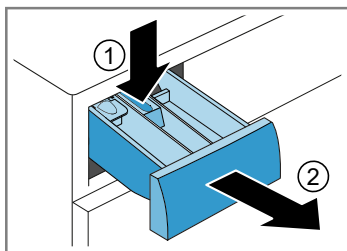

### 4.2.2 Монтиране на чекмеджето за перилен препарат

- ▶ Монтирайте в обратен ред.

## 4.3 Смяна на дръжката на чекмеджето за перилен препарат

### Изискване:

- ✓ Уредът е изключен от захранването.
- ✓ Уредът е изключен от водоснабдителната мрежа.
- ✓ [Чекмеджето за перилния препарат е свалено.→8](#)

### 4.3.1 Сваляне на дръжката на чекмеджето за перилен препарат

1. Освободете крепежните елементи.

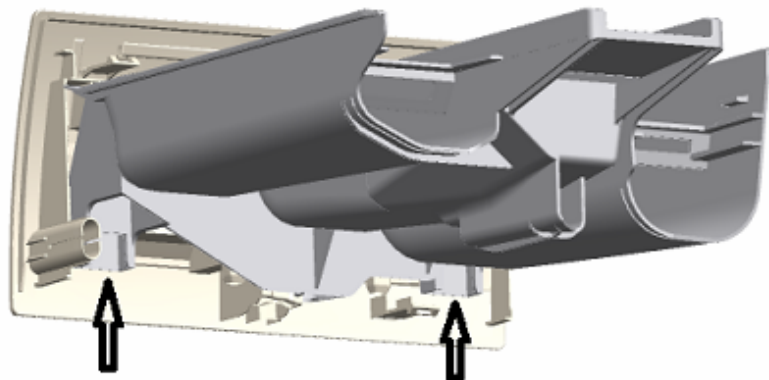

2. Свалете дръжката на чекмеджето за перилен препарат.

### 4.3.2 Монтиране на дръжката на чекмеджето за перилен препарат

- ▶ Монтирайте в обратен ред.

## 4.4 Смяна на фасадния панел

Като производител сме задължени да предоставим на потребителите като резервна част лицевия панел, включително инструкцията за ремонт в съответствие с Регламента (ЕС) 2019/2023. Бихме искали да отбележим обаче, че след смяната на лицевия панел е необходимо да се извърши електротехническа проверка за безопасност от квалифициран електротехник, преди уредът да бъде пуснат в експлоатация. Това лице трябва да бъде с потвърдена квалификация съгласно специфичните за страната закони, разпоредби и стандарти.

	<b>⚠ ОПАСНОСТ</b>
	<p><b>Риск от токов удар поради части под напрежение!</b>                  Опасност за живота от токов удар в случай на неправилен ремонт</p> <ul style="list-style-type: none"> <li>▶ Електрическите части трябва да се ремонтират от квалифицирани електротехници.</li> <li>▶ След ремонта трябва да се извърши проверка за безопасност съгласно VDE 0701 или в съответствие със специфичните за страната разпоредби.</li> </ul>

	<b>⚠ ПРЕДУПРЕЖДЕНИЕ</b>
	<p><b>Приплъзване на наклонени уреди!</b>                  Костни фрактури/наранявания от премазване</p> <ul style="list-style-type: none"> <li>▶ Укрепете уредите срещу приплъзване.</li> </ul>

	<b>⚠ ВНИМАТЕЛНО</b>
	<p><b>Остри ръбове на корпуса!</b>                  Наранявания от порязване</p> <ul style="list-style-type: none"> <li>▶ Носете предпазни ръкавици.</li> </ul>

	<b>⚠ ВНИМАТЕЛНО</b>
	<p><b>Риск от падащи части поради разхлабени винтове!</b>                  Нараняване поради падащи части.</p> <ul style="list-style-type: none"> <li>▶ Закрепете компонента, така че да не падне.</li> </ul>

	<b>ВНИМАНИЕ!</b>
	<p><b>Риск от падащи части поради разхлабени винтове!</b>                  Повреда на други части на уреда или в дома на клиента, напр. дъното.</p> <ul style="list-style-type: none"> <li>▶ Закрепете компонента, така че да не падне.</li> </ul>

### Изискване:

- ✓ Уредът е изключен от захранването.
- ✓ Уредът е изключен от водоснабдителната мрежа.
- ✓ [Горният работен плот е отстранен. → 7](#)
- ✓ [Чекмеджето за перилния препарат е свалено. → 8](#)

### 4.4.1 Сваляне на фасадния панел

1. 1. Свалете винтовете (1).
2. Освободете крепежните елементи (2, 3).

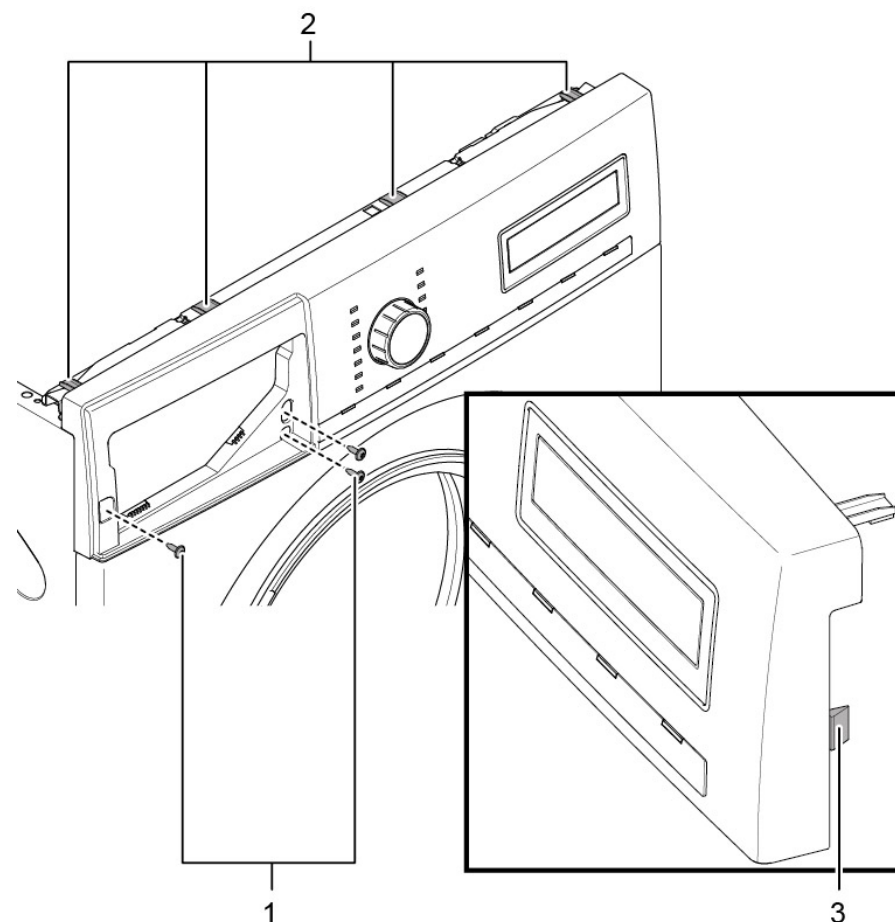

2. Освободете щепселното съединение на контролния блок.
3. Свалете фасадния панел.

#### 4.4.2 Монтиране на фасадния панел





Следете изолацията на кабела. Кабелът може да е захванат.

- ▶ Монтирайте в обратен ред.

## 4.5 Смяна на вратата

	<b>⚠ ВНИМАТЕЛНО</b> <b>Отворете областта на пантите!</b> Премазване/захващане на пръстите ▶ Не посягайте към областта на пантите. ▶ Носете предпазни ръкавици.
--	--

	<b>⚠ ВНИМАТЕЛНО</b> <b>Риск от падащи части поради разхлабени винтове!</b> Нараняване поради падащи части. ▶ Закрепете компонента, така че да не падне.
--	--

	<b>ВНИМАНИЕ!</b> <b>Риск от падащи части поради разхлабени винтове!</b> Повреда на други части на уреда или в дома на клиента, напр. дъното. ▶ Закрепете компонента, така че да не падне.
--	--

### Изискване:

- ✔ Уредът е изключен от захранването.
- ✔ Уредът е изключен от водоснабдителната мрежа.
- ✔ Вратата е отворена.

### 4.5.1 Изваждане на вратата

1. Свалете винтовете (1).

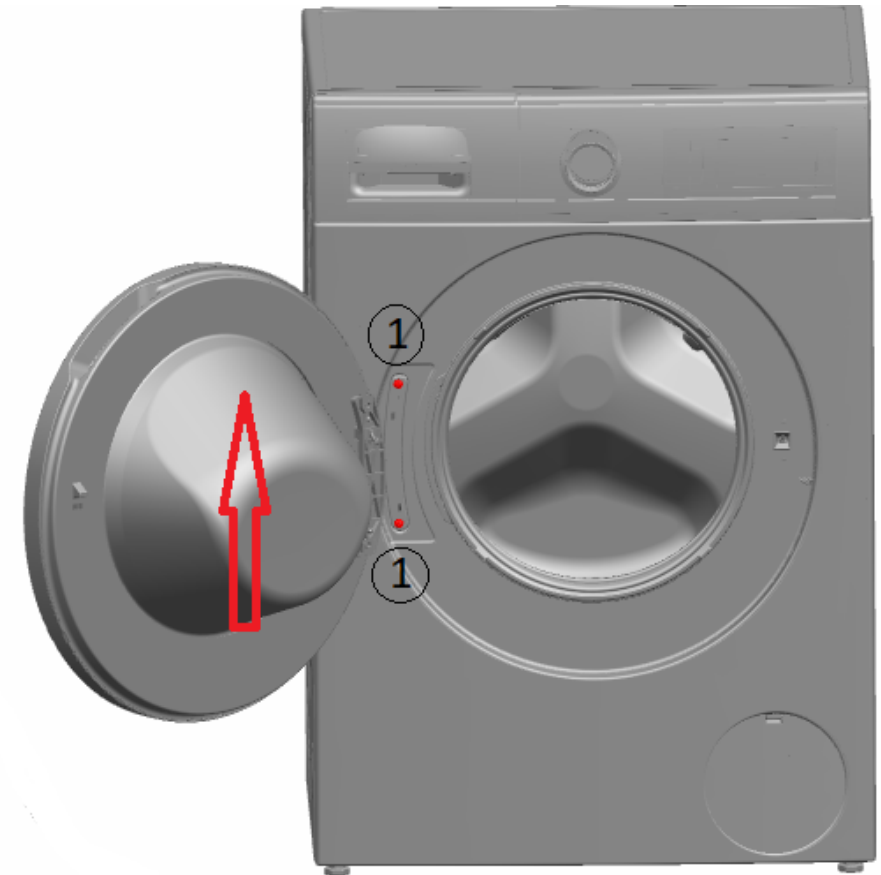



2. Извадете вратата нагоре.

### 4.5.2 Монтиране на вратата

- ▶ Монтирайте в обратен ред.

## 4.6 Смяна на компонентите на вратата

	<b>⚠ ПРЕДУПРЕЖДЕНИЕ</b>
	<b>Тежки и подвижни компоненти!</b> Риск от премазване по време на ремонт, поддръжка, отстраняване на неизправности и техническо обслужване <ul style="list-style-type: none"><li>▶ Носете защитни обувки.</li><li>▶ Закрепете тежките компоненти, така че да не паднат.</li><li>▶ Не позволявайте контакт на части от тялото с движещи се компоненти.</li></ul>

	<b>⚠ ВНИМАТЕЛНО</b>
	<b>Отворете областта на пантите!</b> Премазване/захващане на пръстите <ul style="list-style-type: none"><li>▶ Не посягайте към областта на пантите.</li><li>▶ Носете предпазни ръкавици.</li></ul>

### Изискване:

- ✔ Уредът е изключен от захранването.
- ✔ Уредът е изключен от водоснабдителната мрежа.
- ✔ [Вратата е свалена.→12](#)

### 4.6.1 Сваляне на компонентите на вратата

- ▶ Разглобете вратата отвън навътре.

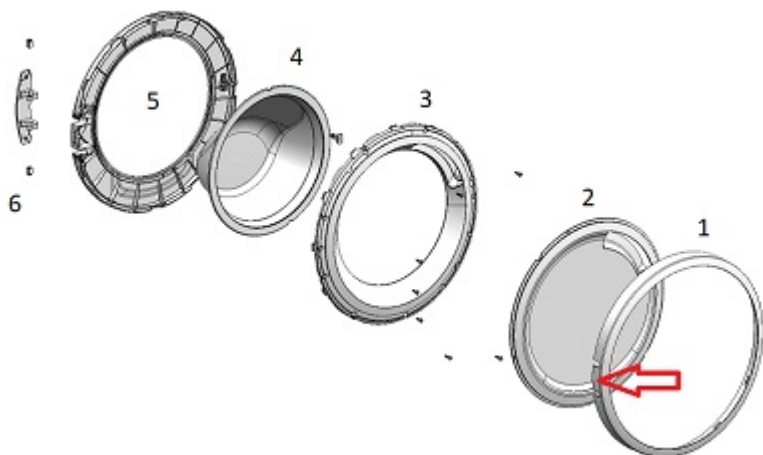

### 4.6.2 Монтиране на компонентите на вратата

- ▶ Монтирайте в обратен ред.

## 4.7 Смяна на капака на помпата

### Изискване:

- ✓ Уредът е изключен от захранването.
- ✓ Уредът е изключен от водоснабдителната мрежа.

### 4.7.1 Сваляне на капака на помпата

1. Отворете капака на помпата.

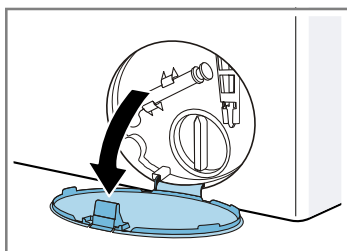

2. Свалете капака на помпата.

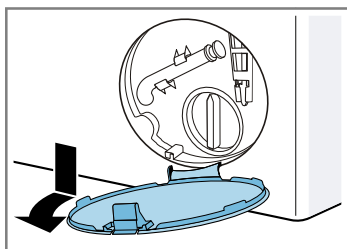



### 4.7.2 Монтиране на капака на помпата

- ▶ Монтирайте в обратен ред.

## 4.8 Смяна на уплътнението на вратата

	<p><b>⚠ ВНИМАТЕЛНО</b></p> <p><b>Остри ръбове на корпуса!</b> Наранявания от порязване</p> <ul style="list-style-type: none"> <li>▶ Носете предпазни ръкавици.</li> </ul>
--	---

	<p><b>⚠ ВНИМАТЕЛНО</b></p> <p><b>Риск от падащи части поради разхлабени винтове!</b> Нараняване поради падащи части.</p> <ul style="list-style-type: none"> <li>▶ Закрепете компонента, така че да не падне.</li> </ul>
--	---

	<p><b>ВНИМАНИЕ!</b></p> <p><b>Риск от падащи части поради разхлабени винтове!</b> Повреда на други части на уреда или в дома на клиента, напр. дъното.</p> <ul style="list-style-type: none"> <li>▶ Закрепете компонента, така че да не падне.</li> </ul>
--	---

### Изискване:

- ✓ Уредът е изключен от захранването.
- ✓ Уредът е изключен от водоснабдителната мрежа.
- ✓ Уредите са свободно достъпни.
- ✓ [Горният работен плот е отстранен.→7](#)
- ✓ [Чекмеджето за перилния препарат е свалено.→8](#)
- ✓ [Лицевият панел е свален.→10](#)
- ✓ [Вратата е свалена.→12](#)
- ✓ [Капакът на помпата е свален.→14](#)
- ✓ [Предният панел е свален.→19](#)
- ✓ [Осветлението на барабана е отстранено \(опция\).→18](#)

### 4.8.1 Сваляне на уплътнението на вратата

1. Освободете всички съединителни елементи за маркучи.

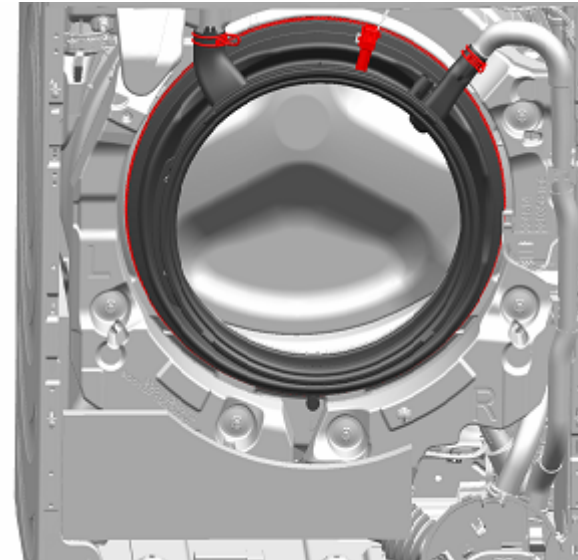

2. Извадете уплътнението на вратата.

### 4.8.2 Монтиране на уплътнението на вратата

	<p><b>⚠ ПРЕДУПРЕЖДЕНИЕ</b></p> <p><b>Риск от падащи части поради неправилен монтаж!</b> Нараняване или повреждане на уреда.</p> <ul style="list-style-type: none"> <li>▶ Натегнете притискащия пръстен на уплътнението на вратата с 3,4 Nm.</li> </ul>
--	--

- ▶ Монтирайте в обратен ред.

## 4.9 Смяна на ключа на вратата

Като производител сме задължени да предоставим на потребителите като резервна част ключалка за вратата, включително инструкцията за ремонт в съответствие с Регламента (ЕС) 2019/2023. Бихме искали да отбележим обаче, че след смяната на ключалката на вратата е необходимо да се извърши електротехническа проверка за безопасност от квалифициран електротехник, преди уредът да бъде пуснат в експлоатация. Това лице трябва да бъде с потвърдена квалификация съгласно специфичните за страната закони, разпоредби и стандарти.

	<b>⚠ ОПАСНОСТ</b>
	<p><b>Риск от токов удар поради части под напрежение!</b>                  Опасност за живота от токов удар в случай на неправилен ремонт</p> <ul style="list-style-type: none"> <li>▶ Електрическите части трябва да се ремонтират от квалифицирани електротехници.</li> <li>▶ След ремонта трябва да се извърши проверка за безопасност съгласно VDE 0701 или в съответствие със специфичните за страната разпоредби.</li> </ul>

	<b>⚠ ПРЕДУПРЕЖДЕНИЕ</b>
	<p><b>Приплъзване на наклонени уреди!</b>                  Костни фрактури/наранявания от премазване</p> <ul style="list-style-type: none"> <li>▶ Укрепете уредите срещу приплъзване.</li> </ul>

	<b>⚠ ВНИМАТЕЛНО</b>
	<p><b>Остри ръбове на корпуса!</b>                  Наранявания от порязване</p> <ul style="list-style-type: none"> <li>▶ Носете предпазни ръкавици.</li> </ul>

	<b>⚠ ВНИМАТЕЛНО</b>
	<p><b>Риск от падащи части поради разхлабени винтове!</b>                  Нараняване поради падащи части.</p> <ul style="list-style-type: none"> <li>▶ Закрепете компонента, така че да не падне.</li> </ul>

	<b>ВНИМАНИЕ!</b>
	<p><b>Риск от падащи части поради разхлабени винтове!</b>                  Повреда на други части на уреда или в дома на клиента, напр. дъното.</p> <ul style="list-style-type: none"> <li>▶ Закрепете компонента, така че да не падне.</li> </ul>

### Изискване:

- ✓ Уредът е изключен от захранването.
- ✓ Уредът е изключен от водоснабдителната мрежа.
- ✓ Уредите са свободно достъпни.
- ✓ [Горният работен плот е отстранен.→7](#)
- ✓ [Чекмеджето за перилния препарат е свалено.→8](#)
- ✓ [Лицевият панел е свален.→10](#)
- ✓ [Вратата е свалена.→12](#)
- ✓ Обтягачият пръстен е свален.
- ✓ [Уплътнението на вратата е свалено.→15](#)
- ✓ [Капакът на помпата е свален.→14](#)
- ✓ [Предният панел е свален.→19](#)

### 4.9.1 Сваляне на ключалката на вратата

1. Изключете щепсела на ключалката на вратата.
2. Освободете ключалката на вратата.



3. Свалете ключалката на вратата.



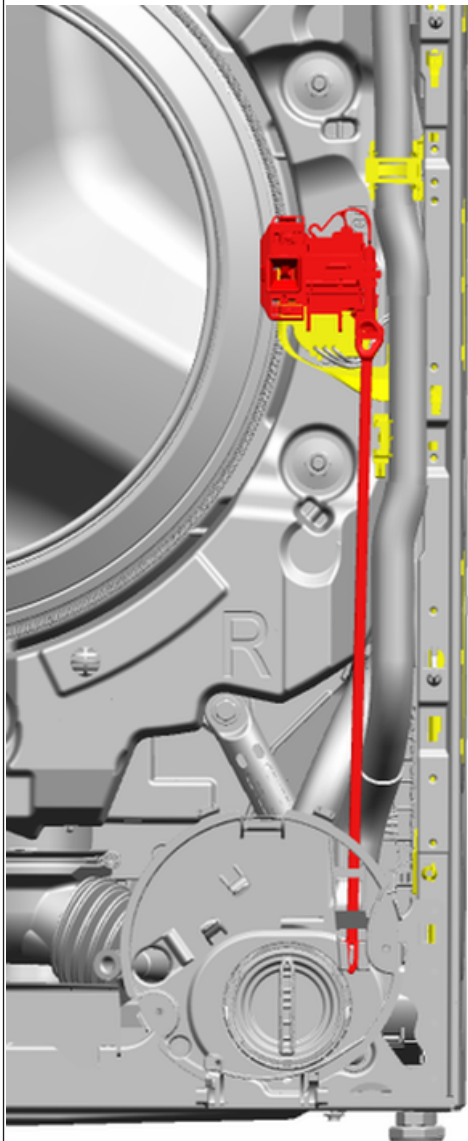

#### 4.9.2 Монтиране на ключалката на вратата

Ключалката на вратата трябва да е в правилното положение, за да осигури функцията за аварийно отваряне на вратата на уреда.



- ▶ Монтирайте в обратен ред.

## 4.10 Смяна на осветлението на барабана

	<p><b>⚠ ПРЕДУПРЕЖДЕНИЕ</b></p> <p><b>Приплъзване на наклонени уреди!</b> Костни фрактури/наранявания от премазване</p> <ul style="list-style-type: none"> <li>▶ Укрепете уредите срещу приплъзване.</li> </ul>
	<p><b>⚠ ВНИМАТЕЛНО</b></p> <p><b>Остри ръбове на корпуса!</b> Наранявания от порязване</p> <ul style="list-style-type: none"> <li>▶ Носете предпазни ръкавици.</li> </ul>
	<p><b>⚠ ВНИМАТЕЛНО</b></p> <p><b>Риск от падащи части поради разхлабени винтове!</b> Нараняване поради падащи части.</p> <ul style="list-style-type: none"> <li>▶ Закрепете компонента, така че да не падне.</li> </ul>
	<p><b>ВНИМАНИЕ!</b></p> <p><b>Риск от падащи части поради разхлабени винтове!</b> Повреда на други части на уреда или в дома на клиента, напр. дъното.</p> <ul style="list-style-type: none"> <li>▶ Закрепете компонента, така че да не падне.</li> </ul>

### Изискване:

- ✔ Уредът е изключен от захранването.
- ✔ Уредът е изключен от водоснабдителната мрежа.
- ✔ Уредите са свободно достъпни.
- ✔ [Горният работен плот е отстранен.→7](#)
- ✔ [Чекмеджето за перилния препарат е свалено.→8](#)
- ✔ [Лицевият панел е свален.→10](#)

### 4.10.1 Сваляне на осветлението на барабана

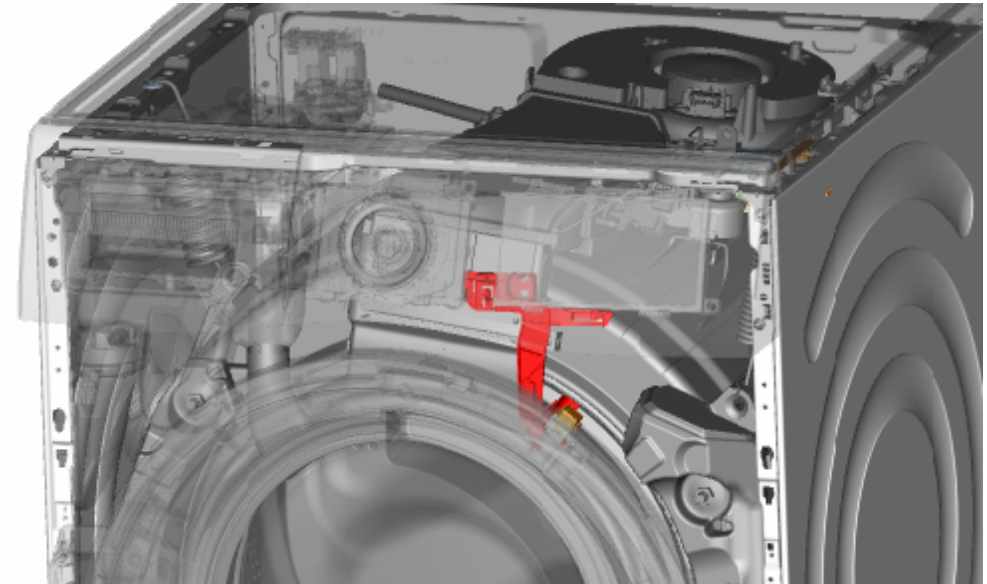

1. Издърпайте държача на осветлението на барабана от уреда.
2. Изключете електрическите връзки.
3. Свалете осветлението на барабана от държача.

### 4.10.2 Монтиране на осветлението на барабана

	<p>Следете изолацията на кабела. Кабелът може да е захванат.</p>
---	--

- ▶ Монтирайте в обратен ред.

## 4.11 Смяна на предния панел



### ПРЕДУПРЕЖДЕНИЕ

**Приплъзване на наклонени уреди!**  
Костни фрактури/наранявания от премазване  
▶ Укрепете уредите срещу приплъзване.



### ВНИМАТЕЛНО

**Остри ръбове на корпуса!**  
Наранявания от порязване  
▶ Носете предпазни ръкавици.



### ВНИМАТЕЛНО











**Риск от падащи части поради разхлабени винтове!**  
Нараняване поради падащи части.  
▶ Закрепете компонента, така че да не падне.



### ВНИМАНИЕ!

**Риск от падащи части поради разхлабени винтове!**  
Повреда на други части на уреда или в дома на клиента, напр. дъното.  
▶ Закрепете компонента, така че да не падне.

#### Изискване:

-  Уредът е изключен от захранването.
-  Уредът е изключен от водоснабдителната мрежа.
-  Уредите са свободно достъпни.
-  [Горният работен плот е отстранен.→7](#)
-  [Чекмеджето за перилния препарат е свалено.→8](#)
-  [Лицевият панел е свален.→10](#)
-  [Вратата е свалена.→12](#)
-  [Капакът на помпата е свален.→14](#)
-  Обтягачият пръстен е свален.
-  Уплътнението на вратата е освободено от предната страна.
-  [Осветлението на барабана е отстранено \(опция\).→18](#)

### 4.11.1 Сваляне на предния панел

1. Повдигнете уреда отпред.
2. Свалете винтовете отдолу (1).

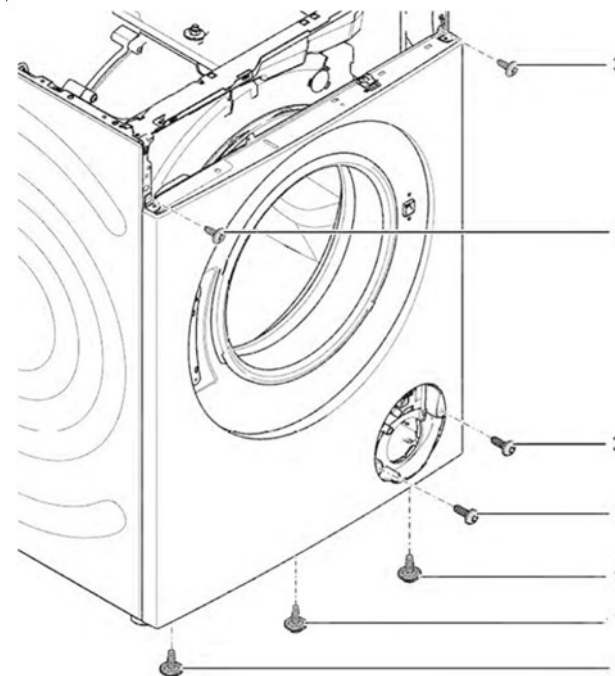

3. Спуснете уреда надолу.

4. Свалете винтовете отпред, като започнете отдолу нагоре (2, 3).

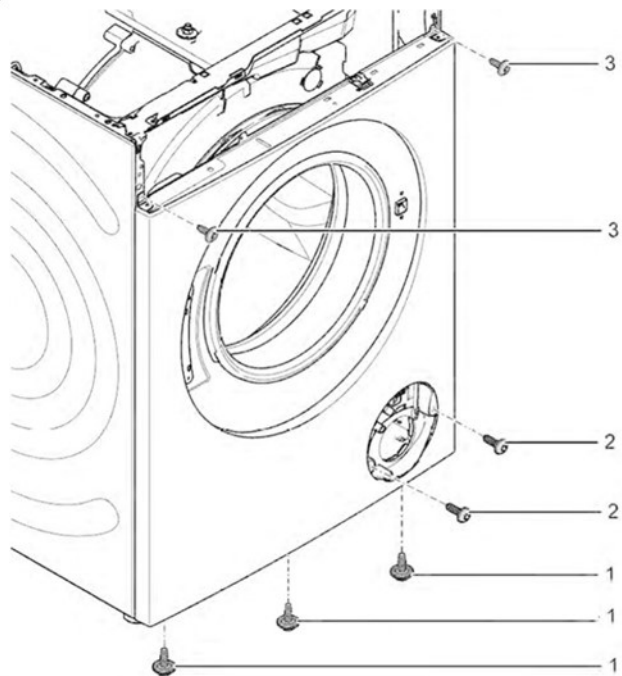





5. Свалете предния панел.

#### 4.11.2 Монтиране на предния панел

- ▶ Монтирайте в обратен ред.

# Savjeti za popravak - Perilica rublja

 <b>O ovom dokumentu</b> .....	<b>22</b>		
1.1 Važne informacije .....	22		
1.1.1 Svrha .....	22		
1.2 Objasnjenje oznaka .....	22		
1.2.1 Stupnjevi opasnosti .....	22		
1.2.2 Oznake opasnosti .....	22		
1.2.3 Struktura upozorenja .....	23		
1.2.4 Opće oznake .....	23		
 <b>Sigurnost</b> .....	<b>24</b>		
2.1 Opće sigurnosne upute .....	24		
2.1.1 Svi kućanski uređaji .....	24		
 <b>Alat i pomagala</b> .....	<b>25</b>		
 <b>Popravak</b> .....	<b>26</b>		
4.1 Zamjena radne ploče .....	26		
4.1.1 Uklanjanje radne ploče .....	26		
4.1.2 Postavljanje radne ploče.....	26		
4.2 Zamjena ladice za deterdžent.....	27		
4.2.1 Uklanjanje ladice za deterdžent .....	27		
4.2.2 Postavljanje ladice za deterdžent .....	27		
4.3 Zamjena ručice ladice za deterdžent.....	28		
4.3.1 Uklanjanje ručice ladice za deterdžent.....	28		
4.3.2 Postavljanje ručice ladice za deterdžent .....	28		
4.4 Zamjena ploče.....	29		
4.4.1 Uklanjanje ploče .....	29		
4.4.2 Postavljanje ploče .....	30		
4.5 Zamjena vrata .....	31		
4.5.1 Uklanjanje vrata .....	31		
4.5.2 Postavljanje vrata.....	31		
4.6 Zamjena sastavnih dijelova vrata.....	32		
4.6.1 Uklanjanje sastavnih dijelova vrata.....	32		
4.6.2 Postavljanje sastavnih dijelova vrata .....	32		
4.7 Zamjena poklopca pumpe .....	33		
4.7.1 Uklanjanje poklopca pumpe .....	33		
4.7.2 Postavljanje poklopca pumpe .....	33		
4.8 Zamjena brtve vrata .....	34		
4.8.1 Uklanjanje brtve vrata .....	34		
4.8.2 Postavljanje brtve vrata .....	34		
4.9 Zamjena brave vrata .....	35		
4.9.1 Uklanjanje brave vrata .....	35		
4.9.2 Postavljanje brave vrata .....	36		
4.10 Zamjena svjetla bubnja.....	37		
4.10.1 Uklanjanje svjetla bubnja .....	37		
4.10.2 Postavljanje svjetla bubnja .....	37		
4.11 Zamjena prednje ploče .....	38		
4.11.1 Uklanjanje prednje ploče .....	38		
4.11.2 Postavljanje prednje ploče .....	39		

# **i** O ovom dokumentu

## 1.1 Važne informacije

### 1.1.1 Svrha

Ove upute za popravak služe kao podrška korisnicima prilikom samostalnog popravljivanja uređaja u skladu s primjenjivom Direktivom o ekološkom dizajnu (od ožujka 2021.).

One sadrže informacije o zamjeni određenih rezervnih dijelova, kao i napomene o upozorenjima i opasnostima.

Ako imate dodatna pitanja, obratite se našoj službi za korisnike. Mi snosimo odgovornost za oštećenja samo u slučaju pridržavanja uputa za popravak.

## 1.2 Objašnjenje oznaka

### 1.2.1 Stupnjevi opasnosti

Stupnjevi upozorenja sastoje se od oznake i signalne riječi. Signalna riječ ukazuje na ozbiljnost opasnosti.





Stupanj upozorenja	Značenje
 <b>OPASNOST</b>	Nepridržavanje poruke upozorenja rezultirat će smrtnim ili teškim ozljedama.
 <b>UPOZORENJE</b>	Nepridržavanje poruke upozorenja može rezultirati smrtnim ili teškim ozljedama.
 <b>OPREZ</b>	Nepridržavanje poruke upozorenja može rezultirati lakšim ozljedama.
 <b>POZORI!</b>	Nepridržavanje poruke upozorenja može rezultirati oštećenjem imovine.

Tablica 1: Stupnjevi opasnosti



### 1.2.2 Oznake opasnosti

Oznake opasnosti simbolička su reprezentacija s oznakom vrste opasnosti.

U ovom dokumentu koriste se sljedeće oznake opasnosti:

Oznaka opasnosti	Značenje
	Opća poruka upozorenja
	Opasnost od električnog napona
	Opasnost od eksplozije
	Opasnost od porezotina
	Opasnost od prignječenja

## O ovom dokumentu

Oznaka opasnosti	Značenje
	Opasnost od vrućih površina
	Opasnost od jakog magnetskog polja
	Opasnost od neionizirajućeg zračenja

Tablica 2: Oznake opasnosti

### 1.2.3 Struktura upozorenja

Upozorenja u ovom dokumentu imaju normirani izgled i strukturu.



	<div style="background-color: red; color: white; padding: 2px; text-align: center;"> <b>OPASNOST</b></div> <p><b>Vrsta i izvor opasnosti!</b> Moguće posljedice zanemarivanja opasnosti/upozorenja.</p> <ul style="list-style-type: none"> <li>▶ Mjere i zabrane za sprječavanje opasnosti.</li> </ul>
--	---





Sljedeći primjer pokazuje upozorenje na strujni udar od dijelova koji provode struju. Spominje se mjera za izbjegavanje opasnosti.

	<div style="background-color: red; color: white; padding: 2px; text-align: center;"> <b>OPASNOST</b></div> <p><b>Opasnost od strujnog udara zbog dijelova koji provode struju!</b> Smrt od strujnog udara</p> <ul style="list-style-type: none"> <li>▶ Isključite uređaj iz električnog napajanja najmanje 60 sekundi prije izvođenja popravaka.</li> </ul>
---	--

### 1.2.4 Opće oznake

U ovom dokumentu koriste se sljedeće opće oznake:

Opća znaka	Značenje
	Oznaka posebnog savjeta (tekst i/ili grafika)
	Oznaka jednostavnog savjeta (samo tekst)
	Oznaka veze na videovodič

Opća znaka	Značenje
	Oznaka potrebnog alata
	Oznaka potrebnih preduvjeta
	Oznaka uvjeta (ako ..., tad ...)
	Oznaka rezultata
Početak	Oznaka tipke ili gumba
[00123456]	Oznaka broja materijala
Status	Oznaka prikazanog teksta / prozor (na zaslonu uređaja)

Tablica 3: Opće oznake

## 2.1 Opće sigurnosne upute

### 2.1.1 Svi kućanski uređaji

#### **Opasnost od strujnog udara zbog dijelova koji provode struju!**

- Pogreške izazvane popravcima električnih sastavnih dijelova mogu dovesti do strujnog udara!
- Isključite uređaj iz struje na najmanje 60 sekundi prije početka radova.
- Nakon popravka provedite sigurnosni test u skladu s VDE 0701 ili nacionalnim propisima.

#### **Opasnost od ozljeda zbog oštih rubova!**

- Nosite zaštitne rukavice.

#### **Opasnost od prignječenja tijekom izvođenja radova na popravcima, održavanju, rješavanju problema i servisiranju teških i pokretnih sastavnih dijelova**

- Nosite zaštitnu obuću.
- Osigurajte teške sastavne dijelove od pada.
- Nemojte umetati dijelove tijela u pokretne sastavne dijelove.







#### **Opasnost za sigurnost/rad uređaja!**

- Koristite samo originalne rezervne dijelove.

#### **Opasnost od oštećenja elektrostatički osjetljivih sastavnih dijelova (ESD)!**

- Nemojte dodirivati module, uključujući priključke i rute vodiča.

## Alat i pomagala

Oznaka	Pojedinosti	Slike
Pomoćni alat [15000155]	Alat za otpuštanje plastičnih dijelova	
Odvijač Torx T20 s provrtom [00340764]	100 mm, za vijke sa sigurnosnim klinom	
Moment ključ [15000441]	Moment ključ 20 - 100 Nm	
Odvijač s utorom [00340854]	Nož 3,5 mm x 0,6 mm x 100 mm, zaštitna izolacija 1000 V AC	
Odvijač s utorom [00340855]	Nož 5,5 mm x 1,0 mm x 125 mm, zaštitna izolacija 1000 V AC	
Kliješta s iglenim nosom, kutni uzorak [00341269]	Duljina 200 mm	
Kliješta za bočno rezanje [00342182]	Duljina: 200 mm	



Oznaka	Pojedinosti	Slike
Kombinirani ključ [00340811]	Veličina ključa 10°mm, M6	
Combination wrench [00340814]	Veličina ključa 13°mm, M8	
Kombinirani ključ [00340817]	Veličina ključa 17 mm, M10	
Kombinirani ključ [15000459]	Veličina ključa 16°mm, M10	

## 4.1 Zamjena radne ploče

### Specijalni alati:

-  Nastavak Torx TX20 s rupom    Duljina 152 mm, iskoristiva duljina 124 mm, 1/4" šesterokutni ključ (6,35 mm), za vijke sa sigurnosnim klinom    [00341272]

### Zahtjev:

-  Uređaj je isključen iz napajanja.
-  Uređaj je isključen iz priključka za dovod vode.

### 4.1.1 Uklanjanje radne ploče

- ▶ 1. Uklonite vijke (1).
- ▶ 2. Gurnite radnu ploču do stražnje strane uređaja (2).
- ▶ 3. Pomaknite radnu ploču prema gore (3) da biste je uklonili.

### 4.1.2 Postavljanje radne ploče



Pripazite tijekom ugradnje kabela. Kabel bi se mogao uglaviti.

- ▶ Postavite obratnim redoslijedom.

## 4.2 Zamjena ladice za deterdžent

### Zahtjev:

- ✓ Uređaj je isključen iz napajanja.
- ✓ Uređaj je isključen iz priključka za dovod vode.

### 4.2.1 Uklanjanje ladice za deterdžent

1. Izvucite ladicu za deterdžent.
2. 1. Pritisnite uložak (1).
2. Uklonite ladicu za deterdžent (2).

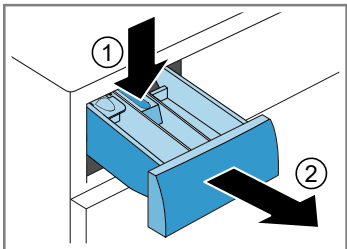

### 4.2.2 Postavljanje ladice za deterdžent

- ▶ Postavite obratnim redoslijedom.

## 4.3 Zamjena ručice ladice za deterdžent

### Zahtjev:

- ✓ Uređaj je isključen iz napajanja.
- ✓ Uređaj je isključen iz priključka za dovod vode.
- ✓ [Ladica za deterdžent je uklonjena.→27](#)

### 4.3.1 Uklanjanje ručice ladice za deterdžent

1. Otpustite zahvatne elemente.

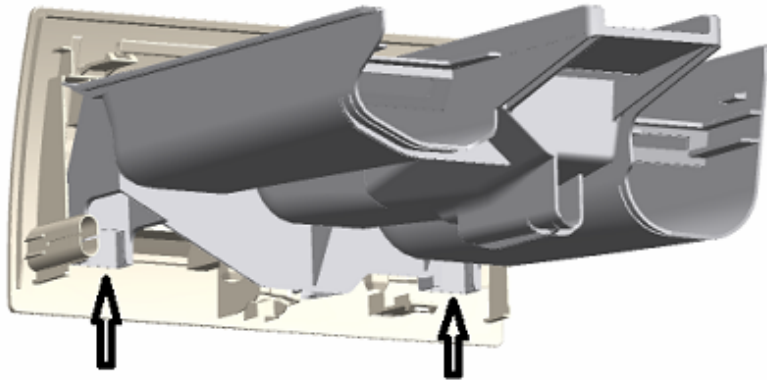





2. Uklonite ručicu ladice za deterdžent.

### 4.3.2 Postavljanje ručice ladice za deterdžent

- ▶ Postavite obratnim redoslijedom.

## 4.4 Zamjena ploče

Kao proizvođač, obvezni smo pružiti potrošačima rezervne dijelove za ploču, uključujući upute za popravak u skladu s Direktivom (EU) 2019/2023. Međutim, želimo naglasiti da nakon zamjene ploče kvalificirani elektrotehničar mora provesti elektrotehnički sigurnosni test prije puštanja uređaja u rad. Ta osoba mora biti potvrđeno kvalificirana u skladu s nacionalnim zakonima, propisima i normama.

	<p style="text-align: center;"><b>⚠️ OPASNOST</b></p> <p><b>Opasnost od strujnog udara zbog dijelova koji provode struju!</b> U slučaju nepravilnog popravka može doći do opasnosti za život od strujnog udara</p> <ul style="list-style-type: none"> <li>▶ Električne dijelove mora popraviti kvalificirani električar.</li> <li>▶ Nakon popravka provedite sigurnosni test u skladu s VDE 0701 ili nacionalnim propisima.</li> </ul>
	<p style="text-align: center;"><b>⚠️ UPOZORENJE</b></p> <p><b>Isklizavanje nagnutih uređaja!</b> Puknuća kostiju / ozljede od prignječenja</p> <ul style="list-style-type: none"> <li>▶ Osigurajte uređaje od isklizavanja.</li> </ul>
	<p style="text-align: center;"><b>⚠️ OPREZ</b></p> <p><b>Oštri rubovi kućišta!</b> Porezotine</p> <ul style="list-style-type: none"> <li>▶ Nosite zaštitne rukavice.</li> </ul>
	<p style="text-align: center;"><b>⚠️ OPREZ</b></p> <p><b>Opasnost od padanja dijelova zbog otpuštenih vijaka!</b> Ozljeda od dijelova koji padaju.</p> <ul style="list-style-type: none"> <li>▶ Osigurajte sastavne dijelove od pada.</li> </ul>
	<p style="text-align: center;"><b>⚠️ POZOR!</b></p> <p><b>Opasnost od padanja dijelova zbog otpuštenih vijaka!</b> Oštećenje drugih dijelova uređaja ili objekta klijenta, npr. poda.</p> <ul style="list-style-type: none"> <li>▶ Osigurajte sastavne dijelove od pada.</li> </ul>

### Zahtjev:

- ✔️ Uređaj je isključen iz napajanja.
- ✔️ Uređaj je isključen iz priključka za dovod vode.

- ✔️ [Radna je ploča uklonjena. →26](#)
- ✔️ [Ladica za deterdžent je uklonjena. →27](#)

### 4.4.1 Uklanjanje ploče

1. Uklonite vijke (1).
2. Otpustite zahvatne elemente (2, 3).

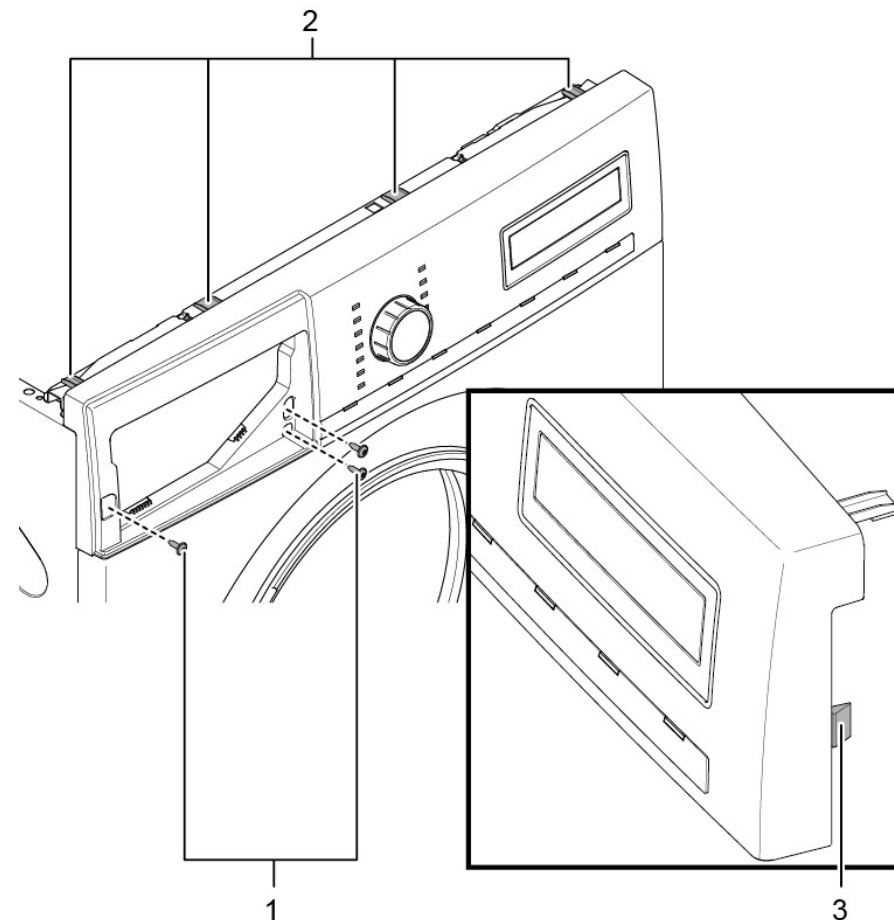

2. Otpustite priključni kontakt upravljačke jedinice.
3. Uklonite ploču.

## 4.4.2 Postavljanje ploče



Pripazite tijekom ugradnje kabela. Kabel bi se mogao uglaviti.

- ▶ Postavite obratnim redoslijedom.

## 4.5 Zamjena vrata



### ⚠️ OPREZ

#### Otvorite područje zgloba!

Prignječenje/zaglavljivanje prstiju

- ▶ Nemojte posezati rukama u područje zgloba.
- ▶ Nosite zaštitne rukavice.



### ⚠️ OPREZ

#### Opasnost od padanja dijelova zbog otpuštenih vijaka!

Ozljeda od dijelova koji padaju.

- ▶ Osigurajte sastavne dijelove od pada.



### ⚠️ POZOR!

#### Opasnost od padanja dijelova zbog otpuštenih vijaka!

Oštećenje drugih dijelova uređaja ili objekta klijenta, npr. poda.

- ▶ Osigurajte sastavne dijelove od pada.

#### Zahtjev:

- ✔ Uređaj je isključen iz napajanja.
- ✔ Uređaj je isključen iz priključka za dovod vode.
- ✔ Vrata su otvorena.

### 4.5.1 Uklanjanje vrata

1. Uklonite vijke (1).

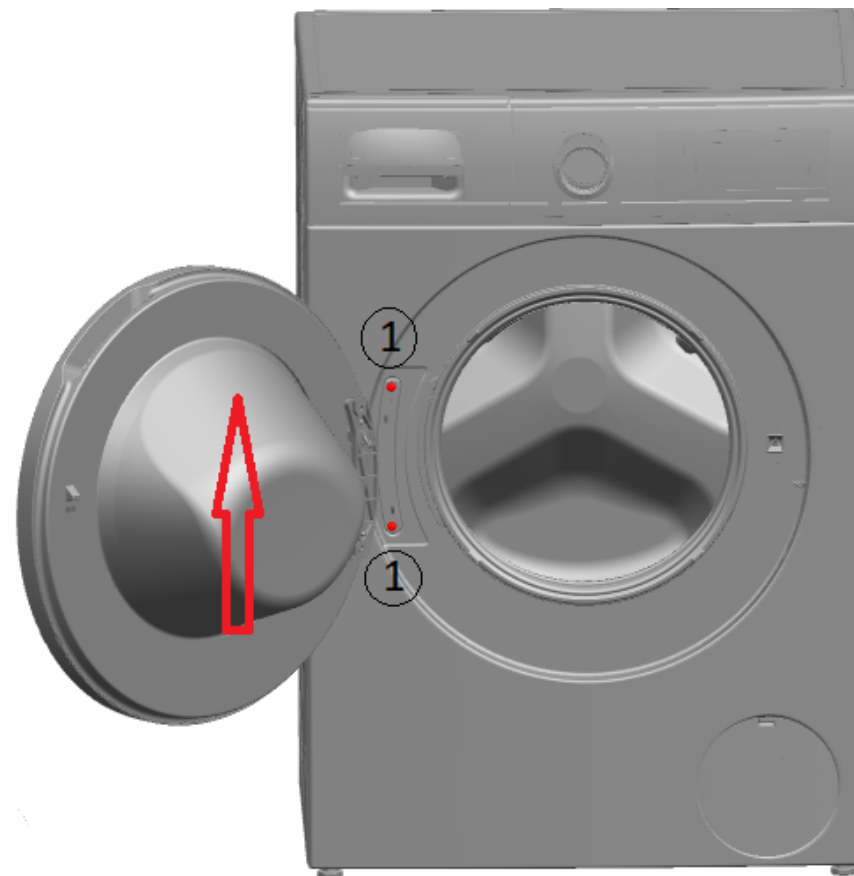



2. Uklonite vrata prema gore.

### 4.5.2 Postavljanje vrata

- ▶ Postavite obratnim redoslijedom.

## 4.6 Zamjena sastavnih dijelova vrata

	<b>⚠️ UPOZORENJE</b>
	<b>Teške i pokretne komponente!</b> Opasnost od prignječenja tijekom izvođenja radova na popravcima, održavanju, rješavanju problema i servisiranju <ul style="list-style-type: none"><li>▶ Nosite zaštitnu obuću.</li><li>▶ Osigurajte teške sastavne dijelove od pada.</li><li>▶ Nemojte umetati dijelove tijela u pokretne sastavne dijelove.</li></ul>

	<b>⚠️ OPREZ</b>
	<b>Otvorite područje zgloba!</b> Prignječenje/zaglavljivanje prstiju <ul style="list-style-type: none"><li>▶ Nemojte posezati rukama u područje zgloba.</li><li>▶ Nosite zaštitne rukavice.</li></ul>

### Zahtjev:

- ✓ Uređaj je isključen iz napajanja.
- ✓ Uređaj je isključen iz priključka za dovod vode.
- ✓ [Vrata su uklonjena. → 31](#)

### 4.6.1 Uklanjanje sastavnih dijelova vrata

- ▶ Rastavite vrata počevši s vanjske prema unutarnjoj strani.

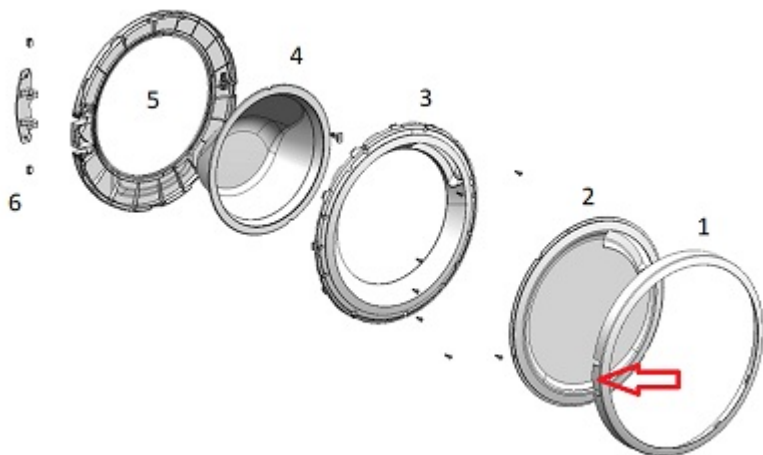

### 4.6.2 Postavljanje sastavnih dijelova vrata

- ▶ Postavite obratnim redoslijedom.

## 4.7 Zamjena poklopca pumpe

### Zahtjev:

- ✓ Uređaj je isključen iz napajanja.
- ✓ Uređaj je isključen iz priključka za dovod vode.

### 4.7.1 Uklanjanje poklopca pumpe

1. Otvorite poklopac pumpe.

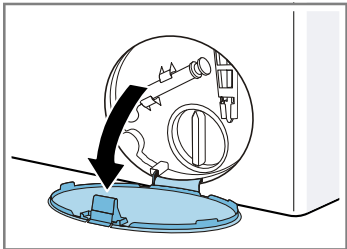

2. Uklonite poklopac pumpe.

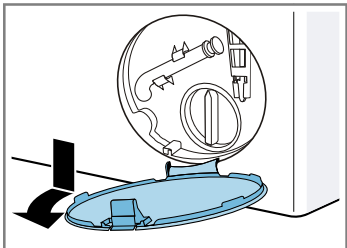



### 4.7.2 Postavljanje poklopca pumpe

- ▶ Postavite obratnim redoslijedom.

## 4.8 Zamjena brtve vrata

	<b>⚠ OPREZ</b> <b>Oštri rubovi kućišta!</b> Porezotine ▶ Nosite zaštitne rukavice.
--	---

	<b>⚠ OPREZ</b> <b>Opasnost od padanja dijelova zbog otpuštenih vijaka!</b> Ozljeda od dijelova koji padaju. ▶ Osigurajte sastavne dijelove od pada.
--	--

	<b>POZOR!</b> <b>Opasnost od padanja dijelova zbog otpuštenih vijaka!</b> Oštećenje drugih dijelova uređaja ili objekta klijenta, npr. poda. ▶ Osigurajte sastavne dijelove od pada.
--	---

### Zahtjev:

- ✔ Uređaj je isključen iz napajanja.
- ✔ Uređaj je isključen iz priključka za dovod vode.
- ✔ Uređaju se može slobodno pristupiti.
- ✔ [Radna je ploča uklonjena.→26](#)
- ✔ [Ladica za deterđent je uklonjena.→27](#)
- ✔ [Ploča je uklonjena.→29](#)
- ✔ [Vrata su uklonjena.→31](#)
- ✔ [Poklopac pumpe je uklonjen.→33](#)
- ✔ [Prednja ploča je uklonjena.→38](#)
- ✔ [Svjetlo bubnja je uklonjeno \(opciono\).→37](#)

## 4.8.1 Uklanjanje brtve vrata

1. Otpustite sve crijevne priključke.



2. Uklonite brtvu vrata.





## 4.8.2 Postavljanje brtve vrata

	<b>⚠ UPOZORENJE</b> <b>Opasnost od padanja dijelova zbog neispravnog postavljanja!</b> Ozljede ili oštećenje uređaja. ▶ Pritegnite zatezni prsten brtve momentom od 3,4 Nm.
--	--

- ▶ Postavite obratnim redoslijedom.

## 4.9 Zamjena brave vrata

Kao proizvođač, obvezni smo pružiti potrošačima rezervne dijelove za bravu vrata, uključujući upute za popravak u skladu s Direktivom (EU) 2019/2023. Međutim, želimo naglasiti da nakon zamjene brave vrata kvalificirani elektrotehničar mora provesti elektrotehnički sigurnosni test prije puštanja uređaja u rad. Ta osoba mora biti potvrđeno kvalificirana u skladu s nacionalnim zakonima, propisima i normama.

	<p><b>⚠️ OPASNOST</b></p> <p><b>Opasnost od strujnog udara zbog dijelova koji provode struju!</b> U slučaju nepravilnog popravka može doći do opasnosti za život od strujnog udara</p> <ul style="list-style-type: none"><li>▶ Električne dijelove mora popraviti kvalificirani električar.</li><li>▶ Nakon popravka provedite sigurnosni test u skladu s VDE 0701 ili nacionalnim propisima.</li></ul>
	<p><b>⚠️ UPOZORENJE</b></p> <p><b>Isklizavanje nagnutih uređaja!</b> Puknuća kostiju / ozljede od prignječenja</p> <ul style="list-style-type: none"><li>▶ Osigurajte uređaje od isklizavanja.</li></ul>
	<p><b>⚠️ OPREZ</b></p> <p><b>Oštri rubovi kućišta!</b> Porezotine</p> <ul style="list-style-type: none"><li>▶ Nosite zaštitne rukavice.</li></ul>
	<p><b>⚠️ OPREZ</b></p> <p><b>Opasnost od padanja dijelova zbog otpuštenih vijaka!</b> Ozljeda od dijelova koji padaju.</p> <ul style="list-style-type: none"><li>▶ Osigurajte sastavne dijelove od pada.</li></ul>
	<p><b>⚠️ POZOR!</b></p> <p><b>Opasnost od padanja dijelova zbog otpuštenih vijaka!</b> Oštećenje drugih dijelova uređaja ili objekta klijenta, npr. poda.</p> <ul style="list-style-type: none"><li>▶ Osigurajte sastavne dijelove od pada.</li></ul>

### Zahtjev:

- ✔ Uređaj je isključen iz napajanja.
- ✔ Uređaj je isključen iz priključka za dovod vode.

- ✔ Uređaju se može slobodno pristupiti.
- ✔ [Radna je ploča uklonjena.→26](#)
- ✔ [Ladica za deterdžent je uklonjena.→27](#)
- ✔ [Ploča je uklonjena.→29](#)
- ✔ [Vrata su uklonjena.→31](#)
- ✔ Zatezni prsten je uklonjen.
- ✔ [Brtva vrata je uklonjena.→34](#)
- ✔ [Poklopac pumpe je uklonjen.→33](#)
- ✔ [Prednja ploča je uklonjena.→38](#)

### 4.9.1 Uklanjanje brave vrata

1. Iskopčajte priključak brave vrata.
2. Otpustite bravu vrata.



3. Uklonite bravu vrata.

## 4.9.2 Postavljanje brave vrata

Brava vrata mora biti u odgovarajućem položaju kako bi se osigurala funkcija otvaranja vrata uređaja za slučaj nužde.

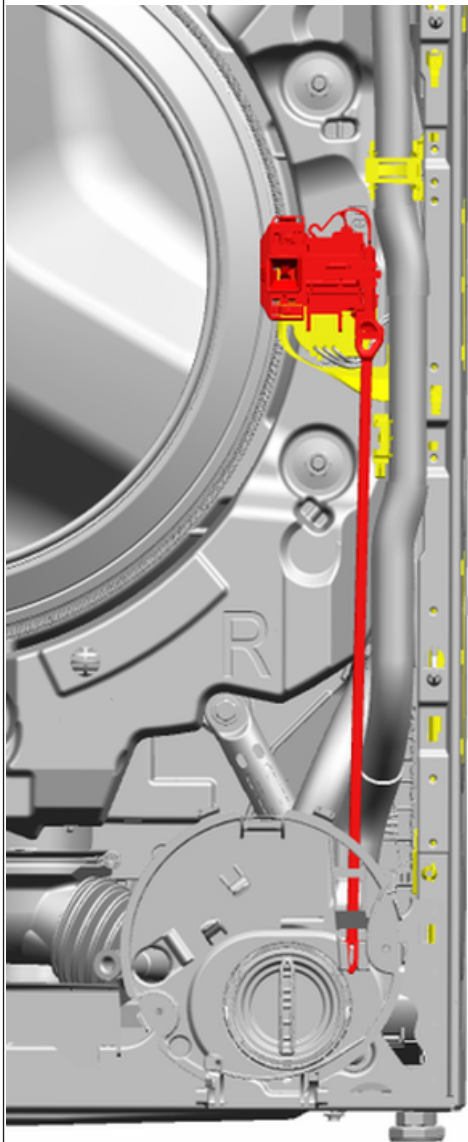

- ▶ Postavite obratnim redoslijedom.

## 4.10 Zamjena svjetla bubnja



### ⚠️ UPOZORENJE

#### Isklizavanje nagnutih uređaja!

Puknuća kostiju / ozljede od prignječenja  
▶ Osigurajte uređaje od isklizavanja.



### ⚠️ OPREZ

#### Oštri rubovi kućišta!

Porezotine  
▶ Nosite zaštitne rukavice.



### ⚠️ OPREZ

#### Opasnost od padanja dijelova zbog otpuštenih vijaka!

Ozljeda od dijelova koji padaju.  
▶ Osigurajte sastavne dijelove od pada.



### ⚠️ POZOR!

#### Opasnost od padanja dijelova zbog otpuštenih vijaka!

Oštećenje drugih dijelova uređaja ili objekta klijenta, npr. poda.  
▶ Osigurajte sastavne dijelove od pada.

#### Zahtjev:

- ✔ Uređaj je isključen iz napajanja.
- ✔ Uređaj je isključen iz priključka za dovod vode.
- ✔ Uređaju se može slobodno pristupiti.
- ✔ [Radna je ploča uklonjena.→26](#)
- ✔ [Ladica za deterđent je uklonjena.→27](#)
- ✔ [Ploča je uklonjena.→29](#)

## 4.10.1 Uklanjanje svjetla bubnja

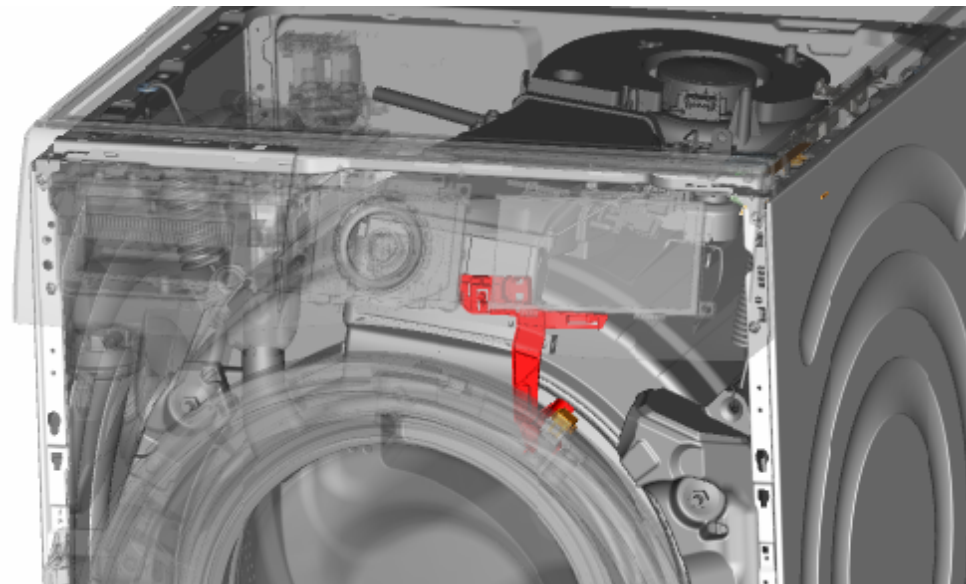

1. Izvucite držač svjetla bubnja iz uređaja.
2. Odvojite električne priključke.
3. Uklonite svjetlo bubnja s držača svjetla bubnja.

## 4.10.2 Postavljanje svjetla bubnja



Pripazite tijekom ugradnje kabela. Kabel bi se mogao uglaviti.

- ▶ Postavite obratnim redoslijedom.

## 4.11 Zamjena prednje ploče



### ⚠️ UPOZORENJE

#### Isklizavanje nagnutih uređaja!

Puknuća kostiju / ozljede od prignječenja  
▶ Osigurajte uređaje od isklizavanja.



### ⚠️ OPREZ

#### Oštri rubovi kućišta!

Porezotine  
▶ Nosite zaštitne rukavice.



### ⚠️ OPREZ

#### Opasnost od padanja dijelova zbog otpuštenih vijaka!

Ozljeda od dijelova koji padaju.  
▶ Osigurajte sastavne dijelove od pada.



### ⚠️ POZOR!

#### Opasnost od padanja dijelova zbog otpuštenih vijaka!

Oštećenje drugih dijelova uređaja ili objekta klijenta, npr. poda.  
▶ Osigurajte sastavne dijelove od pada.

#### Zahtjev:

- ✔ Uređaj je isključen iz napajanja.
- ✔ Uređaj je isključen iz priključka za dovod vode.
- ✔ Uređaju se može slobodno pristupiti.
- ✔ [Radna je ploča uklonjena.→26](#)
- ✔ [Ladica za deterđent je uklonjena.→27](#)
- ✔ [Ploča je uklonjena.→29](#)
- ✔ [Vrata su uklonjena.→31](#)
- ✔ [Poklopac pumpe je uklonjen.→33](#)
- ✔ Zatezni prsten je uklonjen.
- ✔ Brtva vrata je otpuštena s prednje strane.
- ✔ [Svjetlo bubnja je uklonjeno \(opcionarno\).→37](#)

### 4.11.1 Uklanjanje prednje ploče

1. Podignite uređaj s prednje strane.

2. Uklonite vijke s donje strane (1).

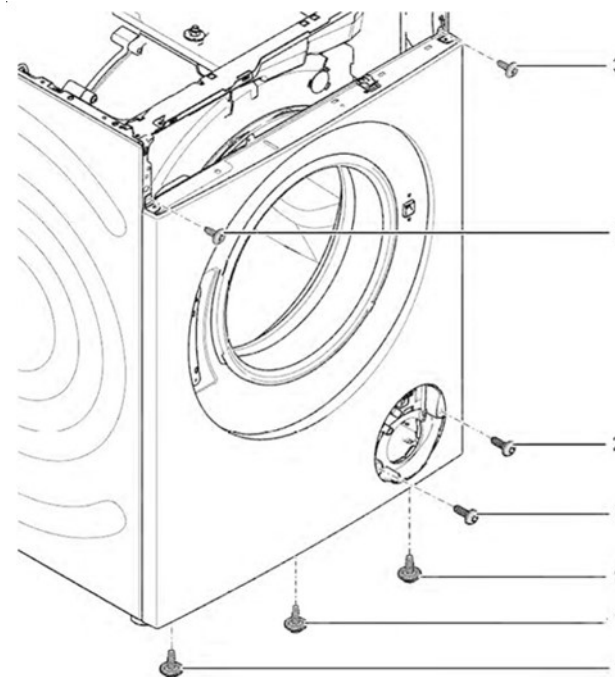

3. Spustite uređaj.

4. Uklonite vijke s prednje strane, počevši od dna prema gore (2, 3).

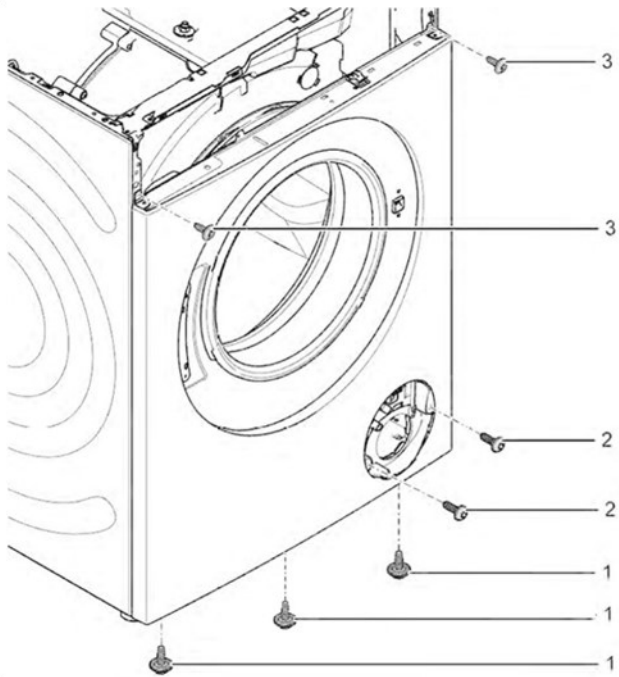





5. Uklonite prednju ploču.

## 4.11.2 Postavljanje prednje ploče

- ▶ Postavite obratnim redoslijedom.

# Poznámky k opravě - Pračka

 <b>O tomto dokumentu</b> .....	<b>41</b>
1.1 Důležité informace .....	41
1.1.1 Účel .....	41
1.2 Vysvětlení symbolů .....	41
1.2.1 Úroveň nebezpečí .....	41
1.2.2 Symboly nebezpečí .....	41
1.2.3 Struktura výstrah .....	42
1.2.4 Obecné symboly .....	42
 <b>Bezpečnost</b> .....	<b>43</b>
2.1 Všeobecné bezpečnostní pokyny .....	43
2.1.1 Všechny domácí spotřebiče .....	43
 <b>Nástroje a pomůcky</b> .....	<b>44</b>
 <b>Oprava</b> .....	<b>45</b>
4.1 Výměna pracovní desky .....	45
4.1.1 Sejmutí pracovní desky .....	45
4.1.2 Montáž pracovní desky .....	45
4.2 Výměna zásuvky na prací prostředek .....	46
4.2.1 Vyjmutí zásuvky na prací prostředek .....	46
4.2.2 Montáž zásuvky na prací prostředek .....	46
4.3 Výměna madla zásuvky na prací prostředek .....	47
4.3.1 Odstranění madla zásuvky na prací prostředek .....	47
4.3.2 Montáž madla zásuvky na prací prostředek .....	47
4.4 Výměna panelu obložení .....	48
4.4.1 Sejmutí panelu obložení .....	48
4.4.2 Montáž panelu obložení .....	49
4.5 Výměna dvířek .....	50
4.5.1 Vyjmutí dvířek .....	50
4.5.2 Montáž dvířek .....	50
4.6 Výměna součástí dvířek .....	51
4.6.1 Odstranění součástí dvířek .....	51
4.6.2 Montáž součástí dvířek .....	51
4.7 Výměna krytu čerpadla .....	52
4.7.1 Odstranění krytu čerpadla .....	52
4.7.2 Montáž krytu čerpadla .....	52

4.8 Výměna těsnění dvířek .....	53
4.8.1 Vyjmutí těsnění dvířek .....	53
4.8.2 Montáž těsnění dvířek .....	53
4.9 Výměna pojistky dvířek .....	54
4.9.1 Odstranění pojistky dvířek .....	54
4.9.2 Montáž pojistky dvířek .....	55
4.10 Výměna osvětlení bubnu .....	56
4.10.1 Odstranění osvětlení bubnu .....	56
4.10.2 Montáž osvětlení bubnu .....	56
4.11 Výměna předního panelu .....	57
4.11.1 Sejmutí předního panelu .....	57
4.11.2 Montáž předního panelu .....	58

# **i** O tomto dokumentu

## 1.1 Důležité informace

### 1.1.1 Účel

Tyto pokyny k opravě pomáhají spotřebiteli při vlastnoruční opravě spotřebičů v souladu s platnými předpisy o ekodesignu (platnými k 03/2021).



Obsahují informace o výměně některých náhradních dílů včetně příslušných výstrah a nebezpečí.

V případě dotazů se obraťte na náš zákaznický servis. Za škody ručíme pouze v případě, že budou správně dodrženy pokyny k opravě.

## 1.2 Vysvětlení symbolů

### 1.2.1 Úroveň nebezpečí

Jednotlivé úrovně výstrah se skládají ze symbolu a signálního slova. Signální slova uvádějí závažnost nebezpečí.





Úroveň výstrahy	Význam
 <b>NEBEZPEČÍ</b>	Nedodržení výstražného upozornění způsobí smrt nebo vážná zranění.
 <b>VÝSTRAHA</b>	Nedodržení výstražného upozornění může způsobit smrt nebo vážná zranění.
 <b>POZOR</b>	Nedodržení výstražného upozornění může způsobit lehká zranění.
<b>POZOR!</b>	Nedodržení výstražného upozornění může způsobit škody na majetku.

Tabulka 1: Úroveň nebezpečí



### 1.2.2 Symboly nebezpečí

Symboly nebezpečí jsou symbolická znázornění určující druh nebezpečí.

V tomto dokumentu jsou použity následující symboly nebezpečí:

Symbol nebezpečí	Význam
	Obecné výstražné upozornění
	Nebezpečí vycházející z elektrického napětí
	Nebezpečí výbuchu
	Nebezpečí pořezání
	Nebezpečí rozdrcení



## O tomto dokumentu

Symbol nebezpečí	Význam
	Nebezpečí spojené s horkými povrchy
	Nebezpečí vycházející ze silného elektromagnetického pole
	Nebezpečí z neionizujícího záření

Tabulka 2: Symboly nebezpečí

### 1.2.3 Struktura výstrah

Výstrahy použité v tomto dokumentu mají standardizovaný vzhled a strukturu.



	<div style="background-color: red; color: white; padding: 2px; text-align: center;"> <b>NEBEZPEČÍ</b></div> <p><b>Typ a zdroj nebezpečí!</b> Možné důsledky nedodržení výstražného upozornění.</p> <ul style="list-style-type: none"> <li>▶ Opatření a zákazy eliminující nebezpečí.</li> </ul>
--	--





Následující příklad ukazuje výstrahu, která varuje před zásahem elektrickým proudem při dotyku dílů pod proudem. Je uvedeno opatření pro zabránění rizika.

	<div style="background-color: red; color: white; padding: 2px; text-align: center;"> <b>NEBEZPEČÍ</b></div> <p><b>Nebezpečí úrazu elektrickým proudem při dotyku dílů pod proudem!</b> Usmrcení elektrickým proudem</p> <ul style="list-style-type: none"> <li>▶ Odpojte spotřebič od přívodu elektrického proudu alespoň 60 sekund před zahájením opravy.</li> </ul>
---	--

### 1.2.4 Obecné symboly

V tomto dokumentu jsou použity následující obecné symboly:

Obecný symbol	Význam
	Uvedení zvláštního tipu (text nebo grafické vyjádření)
	Uvedení jednoduchého tipu (pouze text)
	Uvedení odkazu k videonávodu

Obecný symbol	Význam
	Uvedení požadovaných nástrojů
	Uvedení požadovaných podmínek
	Uvedení podmínky (když, pak atd.)
	Uvedení výsledku
[Start]	Uvedení klávesy nebo tlačítka
[00123456]	Uvedení čísla materiálu
Status	Uvedení zobrazeného textu / okna (na ukazateli spotřebiče)

Tabulka 3: Obecné symboly

## **2.1 Všeobecné bezpečnostní pokyny**

### **2.1.1 Všechny domácí spotřebiče**

#### **Nebezpečí úrazu elektrickým proudem při dotyku dílů pod proudem!**

- Chyby při opravě elektrických součástí mohou vést k úrazu elektrickým proudem!
- Odpojte spotřebič ze sítě alespoň 60 sekund před zahájením prací.
- Po opravě nechte provést bezpečnostní zkoušku podle VDE 0701 nebo specifických předpisů dané země.

#### **Nebezpečí poranění o ostré hrany!**

- Používejte ochranné rukavice.

#### **Nebezpečí rozdrčení během opravy, údržby, odstranění závad a servisu těžkými a pohyblivými součástmi**

- Používejte bezpečnostní obuv.
- Zajistěte těžké součásti před pádem.
- Nesahejte na pohyblivé součásti.







#### **Nebezpečí z hlediska bezpečnosti / funkce spotřebiče!**





- Používejte pouze originální náhradní díly.

#### **Nebezpečí poškození elektrostaticky citlivých součástí (elektrostatický výboj)!**

- Nedotýkejte se modulů, včetně přípojek a vodičů.

## Nástroje a pomůcky

Označení	Detaily	Snímky
Pomocný nástroj [15000155]	Nástroj pro uvolnění plastových dílů	
Šroubovák torx T20 s otvorem [00340764]	100 mm, pro šrouby s pojistným kolíkem	
Momentový klíč [15000441]	Momentový klíč 20–100 Nm	
Plochý šroubovák [00340854]	Čepel 3,5 mm x 0,6 mm x 100 mm, ochranná izolace 1000 V AC	
Plochý šroubovák [00340855]	Čepel 5,5 mm x 1,0 mm x 125 mm, ochranná izolace 1 000 V AC	
Jehlové kleště, zahnuté [00341269]	Délka 200 mm	
Boční štípací kleště [00342182]	Délka: 200 mm	



Označení	Detaily	Snímky
Maticový klíč [00340811]	Velikost klíče 10°mm, M6	
Combination wrench [00340814]	Velikost klíče 13°mm, M8	
Maticový klíč [00340817]	Velikost klíče 17 mm, M10	
Maticový klíč [15000459]	Velikost klíče 16°mm, M10	

## 4.1 Výměna pracovní desky

### Speciální nástroje:

-  Bit torx TX20 s otvorem Délka 152 mm, užitná délka 124 mm, [00341272]  
1/4" šestihran (6,35 mm), pro šrouby  
s pojistným kolíkem

### Požadavek:

-  Spotřebič je odpojený od přívodu elektrické energie.
-  Spotřebič je odpojený od přívodu vody.

### 4.1.1 Sejmutí pracovní desky

- ▶ 1. Odstraňte šrouby (1).
- 2. Posuňte pracovní desku do zadní části spotřebiče (2).
- 3. Zvedněte pracovní desku nahoru (3) a sejměte ji.

### 4.1.2 Montáž pracovní desky



Bud'te pozorní při instalaci kabelu. Mohlo by dojít k zachycení kabelu.

- ▶ Montáž proved'te v opačném sledu.

## 4.2 Výměna zásuvky na prací prostředek

### Požadavek:

- ✔ Spotřebič je odpojený od přívodu elektrické energie.
- ✔ Spotřebič je odpojený od přívodu vody.

### 4.2.1 Vyjmutí zásuvky na prací prostředek

1. Vytáhněte zásuvku na prací prostředek.
2. 1. Zatlačte na vložku (1).  
2. Vyměňte zásuvku na prací prostředek (2).

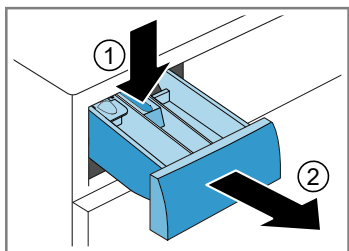

### 4.2.2 Montáž zásuvky na prací prostředek

- ▶ Montáž provedte v opačném sledu.

## 4.3 Výměna madla zásuvky na prací prostředek

### Požadavek:

- ✔ Spotřebič je odpojený od přívodu elektrické energie.
- ✔ Spotřebič je odpojený od přívodu vody.
- ✔ [Zásuvka na prací prostředek je vyjmutá.→46](#)

### 4.3.1 Odstranění madla zásuvky na prací prostředek

1. Uvolněte západky.

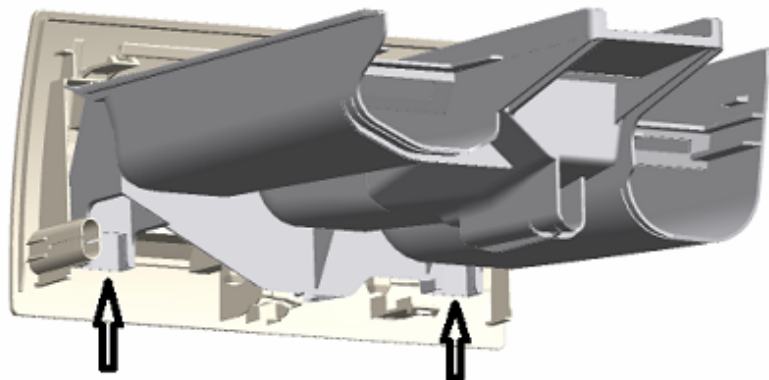

2. Odstraňte madlo zásuvky na prací prostředek.

### 4.3.2 Montáž madla zásuvky na prací prostředek

- ▶ Montáž provedte v opačném sledu.

## 4.4 Výměna panelu obložení

V souladu s nařízením (EU) 2019/2023 jsme coby výrobce povinni poskytnout spotřebitelům náhradní panel obložení včetně návodu k opravě. Upozorňujeme však na to, že po výměně panelu obložení je před uvedením zařízení do provozu vyžadována elektrotechnická bezpečnostní zkouška kvalifikovaným elektrikářem. Tato osoba musí být prokazatelně kvalifikovaná podle zákonů, předpisů a norem platných v dané zemi.

	<b>⚠ NEBEZPEČÍ</b>
	<p><b>Nebezpečí úrazu elektrickým proudem při dotyku dílů pod proudem!</b> V případě neodborné opravy hrozí nebezpečí smrtelného úrazu elektrickým proudem</p> <ul style="list-style-type: none"> <li>▶ Opravu elektrického zařízení smí provádět jen kvalifikovaný elektrikář.</li> <li>▶ Po opravě nechte provést bezpečnostní zkoušku podle VDE 0701 nebo specifických předpisů dané země.</li> </ul>

	<b>⚠ VÝSTRAHA</b>
	<p><b>Sklouznutí nakloněných spotřebičů!</b> Zlomeniny / poranění rozdrcením</p> <ul style="list-style-type: none"> <li>▶ Zajistěte spotřebiče proti sklouznutí.</li> </ul>

	<b>⚠ POZOR</b>
	<p><b>Ostré hrany skříně!</b> Nebezpečí řezných poranění</p> <ul style="list-style-type: none"> <li>▶ Používejte ochranné rukavice.</li> </ul>

	<b>⚠ POZOR</b>
	<p><b>Nebezpečí padajících dílů kvůli uvolněným šroubům!</b> Poranění padajícími díly.</p> <ul style="list-style-type: none"> <li>▶ Zajistěte jednotlivé součásti před pádem.</li> </ul>

	<b>POZOR!</b>
	<p><b>Nebezpečí padajících dílů kvůli uvolněným šroubům!</b> Poškození jiných částí spotřebiče nebo prvků domácnosti zákazníka, např. podlahy.</p> <ul style="list-style-type: none"> <li>▶ Zajistěte jednotlivé součásti před pádem.</li> </ul>

### Požadavek:

- ✔ Spotřebič je odpojený od přívodu elektrické energie.

- ✔ Spotřebič je odpojený od přívodu vody.
- ✔ [Horní panel je sejmутý. →45](#)
- ✔ [Zásuvka na prací prostředek je vyjmutá. →46](#)

### 4.4.1 Sejmутí panelu obložení

1. Odstraňte šrouby (1).
2. Uvolněte západky (2, 3).

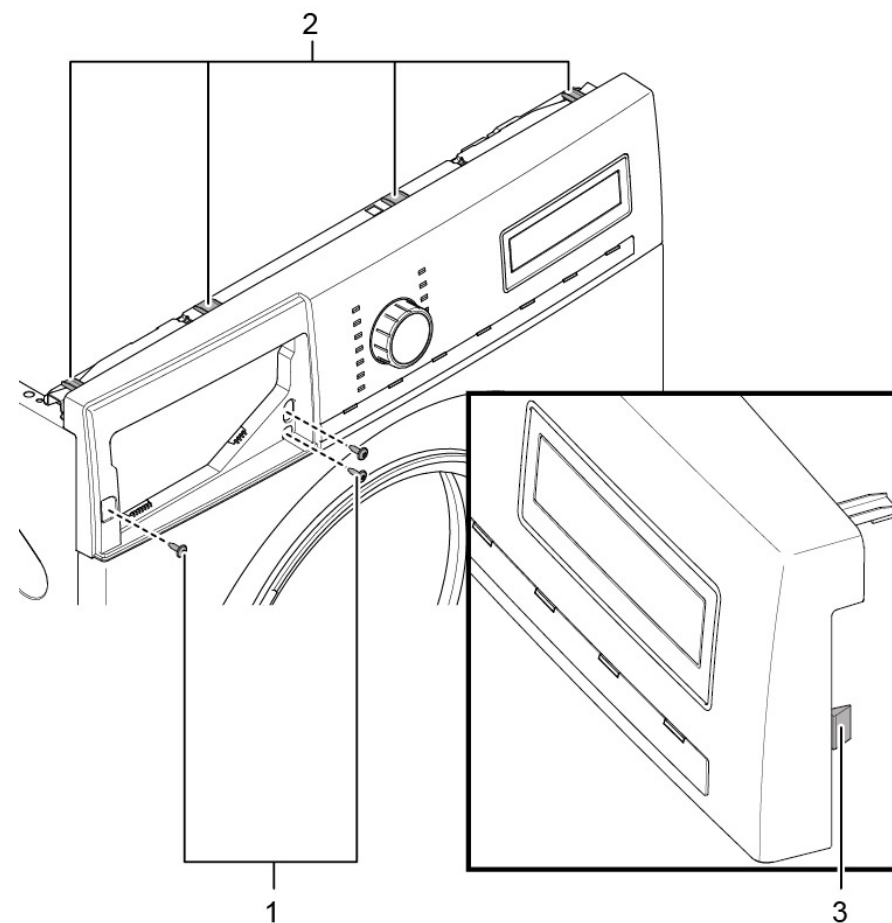

2. Vytáhněte zástrčku řídicí jednotky.
3. Sejměte panel obložení.

## 4.4.2 Montáž panelu obložení



Buďte pozorní při instalaci kabelu. Mohlo by dojít k zachycení kabelu.

- ▶ Montáž proveďte v opačném sledu.

## 4.5 Výměna dvířek



### POZOR

#### Otevřete prostor se závěsy!

Rozdrcení prstů / zachycení

- ▶ Nesahejte do prostoru se závěsy.
- ▶ Používejte ochranné rukavice.



### POZOR

#### Nebezpečí padajících dílů kvůli uvolněným šroubům!

Poranění padajícími díly.

- ▶ Zajistěte jednotlivé součásti před pádem.



### POZOR!

#### Nebezpečí padajících dílů kvůli uvolněným šroubům!

Poškození jiných částí spotřebiče nebo prvků domácnosti zákazníka, např. podlahy.

- ▶ Zajistěte jednotlivé součásti před pádem.

#### Požadavek:

- ✔ Spotřebič je odpojený od přívodu elektrické energie.
- ✔ Spotřebič je odpojený od přívodu vody.
- ✔ Dvířka jsou otevřená.

### 4.5.1 Vyjmutí dvířek

1. Odstraňte šrouby (1).

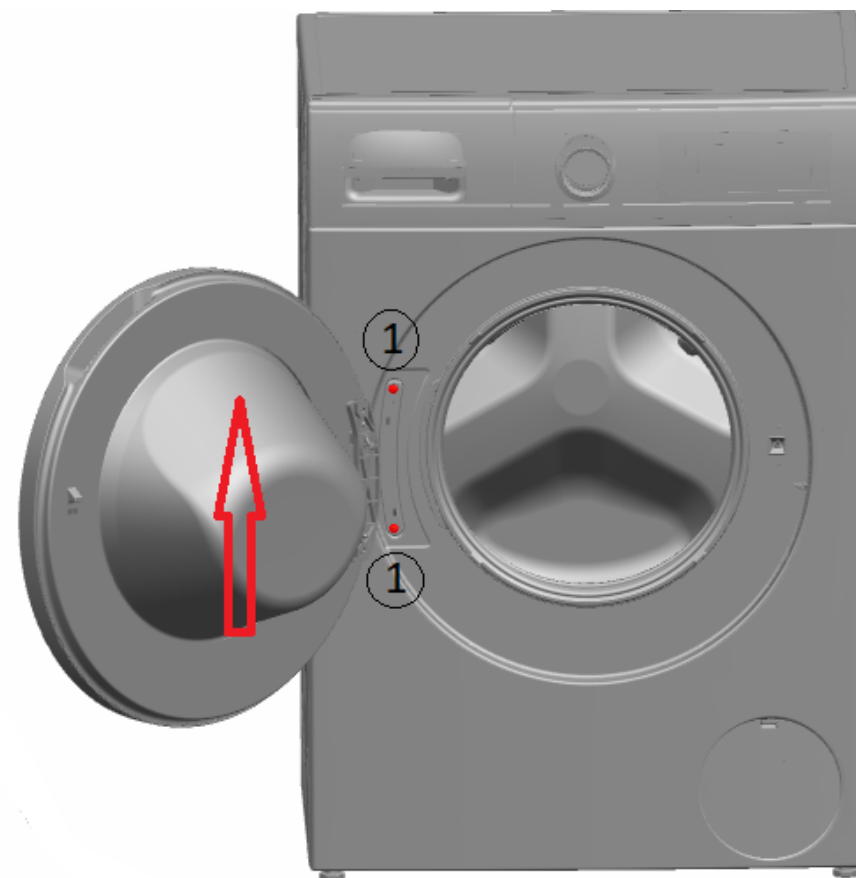

2. Vyjměte dvířka směrem nahoru.

### 4.5.2 Montáž dvířek

- ▶ Montáž proveďte v opačném sledu.

## 4.6 Výměna součástí dvířek



### VÝSTRAHA

#### Těžké a pohyblivé součásti!

Nebezpečí rozdrčení během opravy, údržby, odstranění závad a servisu

- ▶ Používejte bezpečnostní obuv.
- ▶ Zajistěte těžké součásti před pádem.
- ▶ Nesahejte na pohyblivé součásti.



### POZOR

#### Otevřete prostor se závěsy!

Rozdrčení prstů / zachycení

- ▶ Nesahejte do prostoru se závěsy.
- ▶ Používejte ochranné rukavice.

#### Požadavek:

- ✔ Spotřebič je odpojený od přívodu elektrické energie.
- ✔ Spotřebič je odpojený od přívodu vody.
- ✔ [Dvířka jsou odstraněná. → 50](#)

### 4.6.1 Odstranění součástí dvířek

- ▶ Demontujte dvířka zvenku dovnitř.

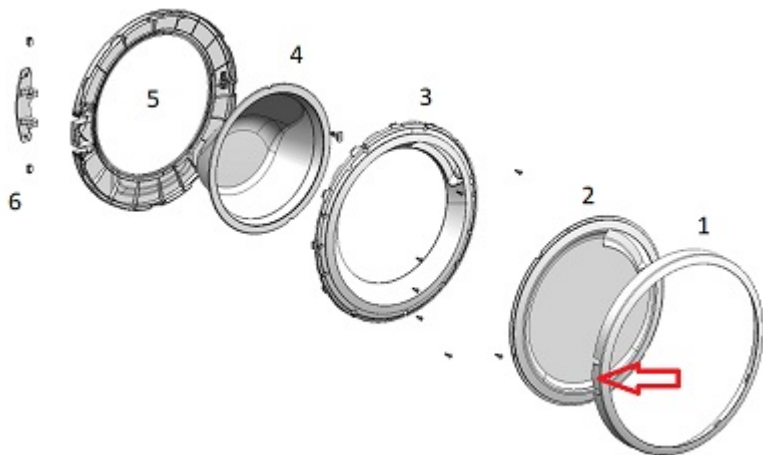

### 4.6.2 Montáž součástí dvířek

- ▶ Montáž proveďte v opačném sledu.

## 4.7 Výměna krytu čerpadla

### Požadavek:

- ✔ Spotřebič je odpojený od přívodu elektrické energie.
- ✔ Spotřebič je odpojený od přívodu vody.

### 4.7.1 Odstranění krytu čerpadla

1. Otevřete kryt čerpadla.

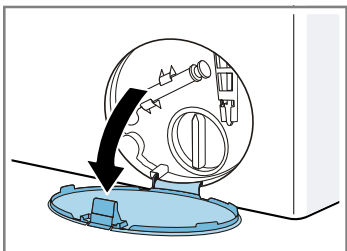

2. Odstraňte kryt čerpadla.

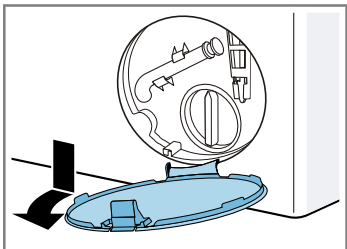

### 4.7.2 Montáž krytu čerpadla

- ▶ Montáž provedte v opačném sledu.

## 4.8 Výměna těsnění dvířek



### POZOR

**Ostré hrany skříně!**  
Nebezpečí řezných poranění  
▶ Používejte ochranné rukavice.



### POZOR

**Nebezpečí padajících dílů kvůli uvolněným šroubům!**  
Poranění padajícími díly.  
▶ Zajistěte jednotlivé součásti před pádem.



### POZOR!

**Nebezpečí padajících dílů kvůli uvolněným šroubům!**  
Poškození jiných částí spotřebiče nebo prvků domácnosti zákazníka, např. podlahy.  
▶ Zajistěte jednotlivé součásti před pádem.

### Požadavek:

- ✔ Spotřebič je odpojený od přívodu elektrické energie.
- ✔ Spotřebič je odpojený od přívodu vody.
- ✔ Spotřebič je volně přístupný.
- ✔ [Horní panel je sejmutý.→45](#)
- ✔ [Zásuvka na prací prostředek je vyjmutá.→46](#)
- ✔ [Panel obložení je sejmutý.→48](#)
- ✔ [Dvířka jsou odstraněná.→50](#)
- ✔ [Kryt čerpadla je odstraněný.→52](#)
- ✔ [Přední panel je sejmutý.→57](#)
- ✔ [Osvětlení bubny je odstraněné \(volitelně\).→56](#)

### 4.8.1 Vyjmutí těsnění dvířek

1. Uvolněte všechny hadicové spoje.

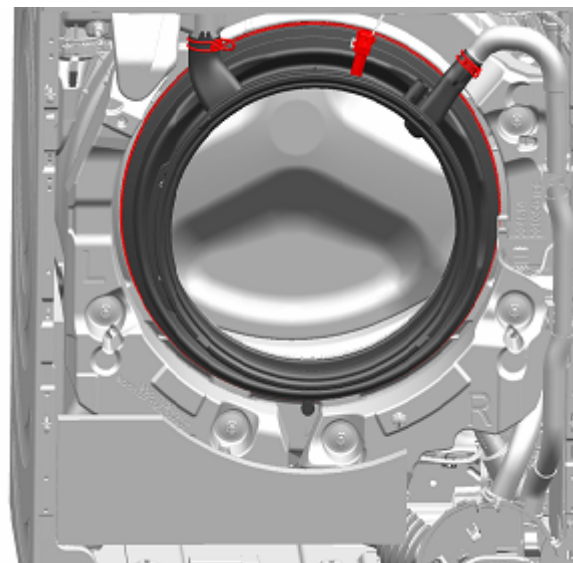

2. Odstraňte těsnění dvířek.

### 4.8.2 Montáž těsnění dvířek



### VÝSTRAHA

**Nebezpečí padajících dílů z důvodu nesprávné montáže!**  
Zranění nebo poškození spotřebiče.  
▶ Utáhněte napínací kroužek těsnění utahovacím momentem 3,4 Nm.

- ▶ Montáž proveďte v opačném sledu.

## 4.9 Výměna pojistky dvířek

V souladu s nařízením (EU) 2019/2023 jsme coby výrobce povinni poskytnout spotřebitelům náhradní pojistku dvířek včetně návodu k opravě. Upozorňujeme však na to, že po výměně pojistky dvířek je před uvedením zařízení do provozu vyžadována elektrotechnická bezpečnostní zkouška kvalifikovaným elektrikářem. Tato osoba musí být prokazatelně kvalifikovaná podle zákonů, předpisů a norem platných v dané zemi.

	<b>⚠ NEBEZPEČÍ</b>
	<p><b>Nebezpečí úrazu elektrickým proudem při dotyku dílů pod proudem!</b> V případě neodborné opravy hrozí nebezpečí smrtelného úrazu elektrickým proudem</p> <ul style="list-style-type: none"> <li>▶ Opravu elektrického zařízení smí provádět jen kvalifikovaný elektrikář.</li> <li>▶ Po opravě nechte provést bezpečnostní zkoušku podle VDE 0701 nebo specifických předpisů dané země.</li> </ul>

	<b>⚠ VÝSTRAHA</b>
	<p><b>Sklouznutí nakloněných spotřebičů!</b> Zlomeniny / poranění rozdrčením</p> <ul style="list-style-type: none"> <li>▶ Zajistěte spotřebiče proti sklouznutí.</li> </ul>

	<b>⚠ POZOR</b>
	<p><b>Ostré hrany skříně!</b> Nebezpečí řezných poranění</p> <ul style="list-style-type: none"> <li>▶ Používejte ochranné rukavice.</li> </ul>

	<b>⚠ POZOR</b>
	<p><b>Nebezpečí padajících dílů kvůli uvolněným šroubům!</b> Poranění padajícími díly.</p> <ul style="list-style-type: none"> <li>▶ Zajistěte jednotlivé součásti před pádem.</li> </ul>

	<b>POZOR!</b>
	<p><b>Nebezpečí padajících dílů kvůli uvolněným šroubům!</b> Poškození jiných částí spotřebiče nebo prvků domácnosti zákazníka, např. podlahy.</p> <ul style="list-style-type: none"> <li>▶ Zajistěte jednotlivé součásti před pádem.</li> </ul>

**Požadavek:**

- ✔ Spotřebič je odpojený od přívodu elektrické energie.

- ✔ Spotřebič je odpojený od přívodu vody.
- ✔ Spotřebič je volně přístupný.
- ✔ [Horní panel je sejmутý.→45](#)
- ✔ [Zásuvka na prací prostředek je vyjmutá.→46](#)
- ✔ [Panel obložení je sejmутý.→48](#)
- ✔ [Dvířka jsou odstraněná.→50](#)
- ✔ Napínací kroužek je vyjmutý.
- ✔ [Těsnění dvířek je vyjmuté.→53](#)
- ✔ [Kryt čerpadla je odstraněný.→52](#)
- ✔ [Přední panel je sejmутý.→57](#)

### 4.9.1 Odstranění pojistky dvířek

1. Vytáhněte zástrčku pojistky dvířek.
2. Uvolněte pojistku dvířek.



3. Odstraňte pojistku dvířek.

## 4.9.2 Montáž pojistky dvířek

Pojistka dvířek musí být ve správné poloze, aby byla zajištěna správná funkce nouzového otevírání dvířek spotřebiče.

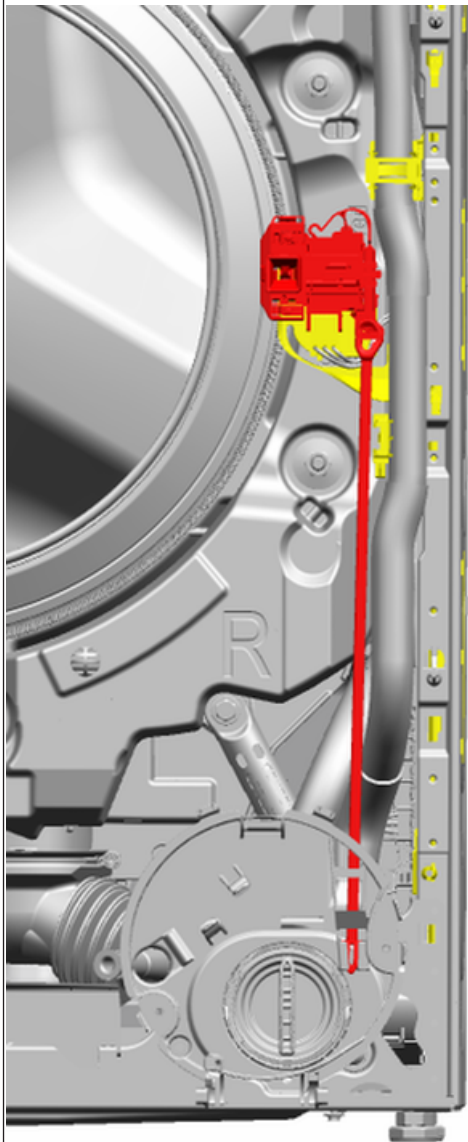

- ▶ Montáž proveďte v opačném sledu.

## 4.10 Výměna osvětlení bubnu



### VÝSTRAHA

**Sklouznutí nakloněných spotřebičů!**  
Zlomeniny / poranění rozdrcením  
▶ Zajistěte spotřebiče proti sklouznutí.



### POZOR

**Ostré hrany skříně!**  
Nebezpečí řezných poranění  
▶ Používejte ochranné rukavice.



### POZOR







**Nebezpečí padajících dílů kvůli uvolněným šroubům!**  
Poranění padajícími díly.  
▶ Zajistěte jednotlivé součásti před pádem.



### POZOR!

**Nebezpečí padajících dílů kvůli uvolněným šroubům!**  
Poškození jiných částí spotřebiče nebo prvků domácnosti zákazníka, např. podlahy.  
▶ Zajistěte jednotlivé součásti před pádem.

### Požadavek:

-  Spotřebič je odpojený od přívodu elektrické energie.
-  Spotřebič je odpojený od přívodu vody.
-  Spotřebič je volně přístupný.
-  [Horní panel je sejmutý.→45](#)
-  [Zásuvka na prací prostředek je vyjmutá.→46](#)
-  [Panel obložení je sejmutý.→48](#)

## 4.10.1 Odstranění osvětlení bubnu

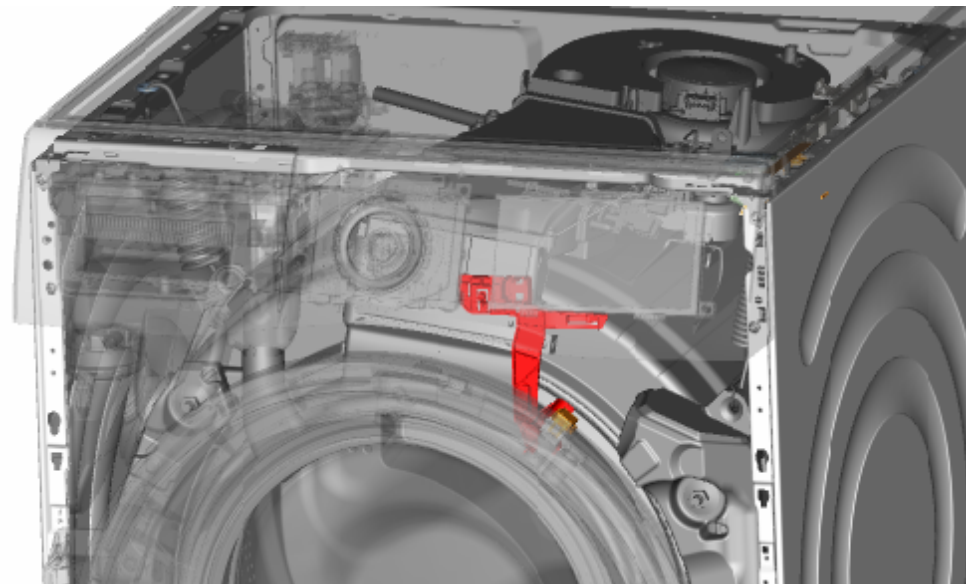

1. Ze spotřebiče vytáhněte držák osvětlení bubnu.
2. Odpojte elektrické připojení.
3. Vyjměte osvětlení bubnu z držáku osvětlení.

## 4.10.2 Montáž osvětlení bubnu



Buďte pozorní při instalaci kabelu. Mohlo by dojít k zachycení kabelu.

- ▶ Montáž proveďte v opačném sledu.

## 4.11 Výměna předního panelu



### **VÝSTRAHA**

**Sklouznutí nakloněných spotřebičů!**  
Zlomeniny / poranění rozdrcením  
▶ Zajistěte spotřebiče proti sklouznutí.



### **POZOR**

**Ostré hrany skříně!**  
Nebezpečí řezných poranění  
▶ Používejte ochranné rukavice.



### **POZOR**

**Nebezpečí padajících dílů kvůli uvolněným šroubům!**  
Poranění padajícími díly.  
▶ Zajistěte jednotlivé součásti před pádem.



### **POZOR!**

**Nebezpečí padajících dílů kvůli uvolněným šroubům!**  
Poškození jiných částí spotřebiče nebo prvků domácnosti zákazníka, např. podlahy.  
▶ Zajistěte jednotlivé součásti před pádem.

#### Požadavek:

- ✔ Spotřebič je odpojený od přívodu elektrické energie.
- ✔ Spotřebič je odpojený od přívodu vody.
- ✔ Spotřebič je volně přístupný.
- ✔ [Horní panel je sejmutý.→45](#)
- ✔ [Zásuvka na prací prostředek je vyjmutá.→46](#)
- ✔ [Panel obložení je sejmutý.→48](#)
- ✔ [Dvířka jsou odstraněná.→50](#)
- ✔ [Kryt čerpadla je odstraněný.→52](#)
- ✔ Napínací kroužek je vyjmutý.
- ✔ Těsnění dvířek je vpředu uvolněné.
- ✔ [Osvětlení bubny je odstraněné \(volitelně\).→56](#)

### 4.11.1 Sejmutí předního panelu

1. Zvedněte přední část spotřebiče.
2. Odstraňte šrouby ve spodní části (1).

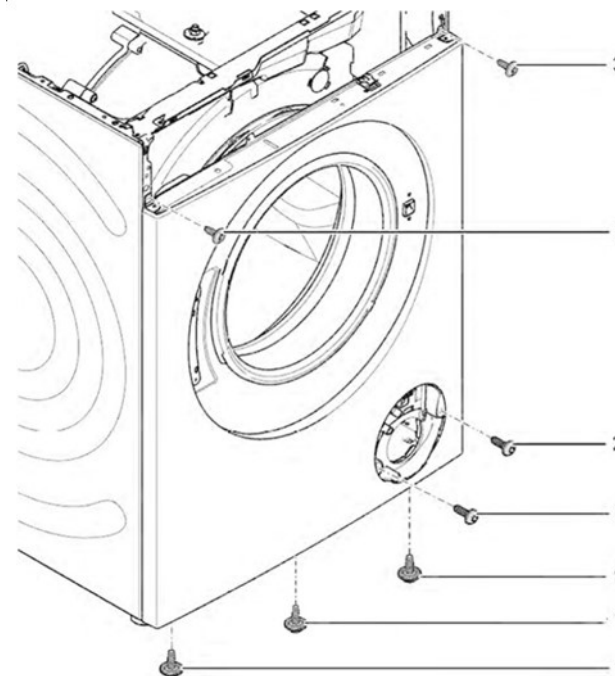

3. Položte spotřebič.

4. V přední části odstraňte šrouby, postupujte zdola nahoru (2, 3).

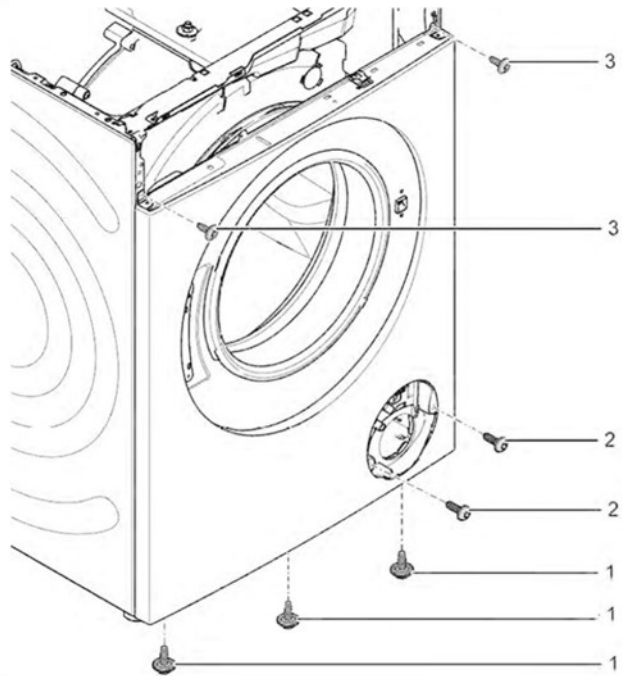

5. Sejměte přední panel.

### 4.11.2 Montáž předního panelu

- ▶ Montáž proveďte v opačném sledu.

# Tip til reparation - Vaskemaskine

 <b>Om dette dokument</b> .....	<b>60</b>
1.1 Vigtig information.....	60
1.1.1 Formål.....	60
1.2 Forklaring af symboler .....	60
1.2.1 Fareniveauer .....	60
1.2.2 Faresymboler.....	60
1.2.3 Advarslernes opbygning .....	61
1.2.4 Generelle symboler .....	61
 <b>Sikkerhed</b> .....	<b>62</b>
2.1 Generelle sikkerhedsanvisninger .....	62
2.1.1 Alle husholdningsapparater .....	62
 <b>Værktøjer og hjælpemidler</b> .....	<b>63</b>
 <b>Reparation</b> .....	<b>64</b>
4.1 Udskiftning af topplade .....	64
4.1.1 Fjernelse af topplade.....	64
4.1.2 Montering af topplade.....	64
4.2 Udskiftning af sæbeskuffe .....	65
4.2.1 Fjernelse af sæbeskuffe .....	65
4.2.2 Montering af sæbeskuffe .....	65
4.3 Udskiftning af sæbeskuffens håndtag .....	66
4.3.1 Fjernelse af sæbeskuffens håndtag.....	66
4.3.2 Montering af sæbeskuffens håndtag.....	66
4.4 Udskiftning af betjeningspanel.....	67
4.4.1 Fjernelse af betjeningspanel .....	67
4.4.2 Montering af betjeningspanel .....	68
4.5 Udskiftning af dør .....	69
4.5.1 Fjernelse af dør.....	69
4.5.2 Montering af dør .....	69
4.6 Udskiftning af dørkomponenter.....	70
4.6.1 Fjernelse af dørkomponenter .....	70
4.6.2 Montering af dørkomponenter .....	70
4.7 Udskiftning af pumpens afdækning .....	71
4.7.1 Fjernelse af pumpens afdækning .....	71
4.7.2 Montering af pumpens afdækning .....	71

4.8 Udskiftning af dørpakning .....	72
4.8.1 Fjernelse af dørpakning .....	72
4.8.2 Montering af dørpakning .....	72
4.9 Udskiftning af dørlås .....	73
4.9.1 Fjernelse af dørlås.....	73
4.9.2 Montering af dørlås.....	74
4.10 Udskiftning af tromlelyls .....	75
4.10.1 Fjernelse af tromlelyls.....	75
4.10.2 Montering af tromlelyls.....	75
4.11 Udskiftning af frontpanel.....	76
4.11.1 Fjernelse af frontpanel .....	76
4.11.2 Montering af frontpanel .....	77

# **i** Om dette dokument

## 1.1 Vigtig information

### 1.1.1 Formål

Disse reparationsanvisninger hjælper kunden til selv at kunne reparere apparater i henhold til den gældende lovgivning om miljøvenligt design (fra 03/2021).





De indeholder information om, hvordan der udskiftes bestemte reservedele, herunder advarsler og risici.

Kontakt kundeservice i tilfælde af spørgsmål. Vi påtager os kun ansvar for skader, hvis reparationsanvisningerne er fuldt korrekt.

## 1.2 Forklaring af symboler

### 1.2.1 Fareniveauer

Advarselsniveauerne består af et symbol og et signalford. Signalfordene indikerer farens alvor.





Advarselsniveau	Betydning
	Manglende overholdelse af advarselsmeddelelsen vil medføre død eller alvorlige kvæstelser.
	Manglende overholdelse af advarselsmeddelelsen kan medføre død eller alvorlige kvæstelser.
	Manglende overholdelse af advarselsmeddelelsen kan medføre mindre kvæstelser.
	Manglende overholdelse af advarselsmeddelelsen kan medføre materiel beskadigelse.

Tabel 1: Fareniveauer





### 1.2.2 Faresymboler

Faresymboler er symbolske visninger, der giver en indikation af faretypen.

Der anvendes følgende faresymboler i dette dokument:

Faresymbol	Betydning
	Generel advarselsmeddelelse
	Fare for elektrisk spænding
	Eksplussionsfare
	Fare for at skære sig

## i Om dette dokument

Faresymbol	Betydning
	Fare for klemning
	Fare pga. varme overflader
	Fare pga. kraftigt magnetfelt
	Fare pga. ikke-ioniserende stråling

Tabel 2: Faresymboler

### 1.2.3 Advarslernes opbygning

Advarsler i dette dokument har et standardiseret udseende og en standardiseret opbygning.

	<div style="background-color: red; color: white; padding: 2px; text-align: center;"><b>FARE</b></div> <p><b>Farens type og kilde!</b> Mulige følger, hvis faren/advarslen ignoreres.</p> <ul style="list-style-type: none"> <li>▶ Foranstaltninger og forbud for at forhindre faren.</li> </ul>
--	---

De følgende eksempler viser en advarsel, der advarer mod elektrisk stød pga. spændingsførende dele. Foranstaltningen til at undgå faren er nævnt.

	<div style="background-color: red; color: white; padding: 2px; text-align: center;"><b>FARE</b></div> <p><b>Fare for elektrisk stød pga. spændingsførende dele!</b> Død ved elektrisk stød</p> <ul style="list-style-type: none"> <li>▶ Afbryd apparater fra strømforsyningen i mindst 60 sekunder, før reparationer påbegyndes.</li> </ul>
--	---

### 1.2.4 Generelle symboler

Der anvendes følgende generelle symboler i dette dokument:

Generelt symbol	Betydning
	Angivelse af et særligt tip (tekst og/eller grafik)
	Angivelse af et simpelt tip (kun tekst)
	Angivelse af et link til en videotutorial
	Angivelse af nødvendige værktøjer
	Angivelse af krævede forudsætninger
	Angivelse af en betingelse (hvis..., så...)
	Angivelse af et resultat
	Angivelse af en tast eller knap
	Angivelse af et materialenummer
	Angivelse af en vist tekst/et vist vindue (i apparatets display)

Tabel 3: Generelle symboler

## 2.1 Generelle sikkerhedsanvisninger

### 2.1.1 Alle husholdningsapparater

#### **Fare for elektrisk stød pga. spændingsførende dele!**

- Fejl i forbindelse med reparationer, der involverer elektriske komponenter, kan medføre elektrisk stød!
- Afbryd apparatet fra strømmenet i mindst 60 sekunder, før arbejdet påbegyndes.
- Få efter reparationen udført en sikkerhedstest i henhold til VDE 0701 eller landespecifikke forskrifter.

#### **Fare for tilskadekomst pga. skarpe kanter!**

- Brug beskyttelseshandsker.

#### **Fare for klemning i forbindelse med reparation, vedligeholdelse, fejlafhjælpning og service på grund af tunge og bevægelige komponenter**

- Brug sikkerhedssko.
- Sørg for at sikre tunge komponenter mod at falde ned.
- Stik kropsdele ind i bevægelige komponenter.







#### **Fare for apparatets sikkerhed/funktion!**





- Brug kun originale reservedele.

#### **Fare for beskadigelse af elektrostatisk følsomme komponenter (elektrostatiske afladninger)!**

- Berør ikke modulerne, herunder forbindelser og ledningsbaner.

## Værktøjer og hjælpemidler

Betegnelse	Detaljer	Billeder
Hjælpeværktøj [15000155]	Værktøj til at løsne plastikdele ud	
Skruetrækker Torx T20 med borehul [00340764]	100 mm for skruer med sikringsstift	
Momentnøgle [15000441]	Momentnøgle 20 - 100 Nm	
Kærviskruestrækker [00340854]	Blad 3,5 mm x 0,6 mm x 100 mm, beskyttelsesisolering 1000 V AC	
Kærviskruestrækker [00340855]	Blad 5,5 mm x 1,0 mm x 125 mm, beskyttelsesisolering 1000 V AC	
Nåletænger, vinklet [00341269]	Længde 200 mm	
Bidetænger [00342182]	Længde: 200 mm	



Betegnelse	Detaljer	Billeder
Fastnøgle [00340811]	Fastnøgle størrelse 10 <sup>o</sup> mm, M6	
Combination wrench [00340814]	Fastnøgle størrelse 13 <sup>o</sup> mm, M8	
Fastnøgle [00340817]	Fastnøgle størrelse 17 mm, M10	
Fastnøgle [15000459]	Fastnøgle størrelse 16 <sup>o</sup> mm, M10	

## 4.1 Udskiftning af topplade

### Nødvendig værktøj:

-  Torx-bit TX20 med hul Længde 152 mm, anvendelig længde [00341272]  
124 mm, 1/4" sekskant (6,35 mm), for  
skruer med sikringsstift

### Preindstilling:

-  Apparatet er afbrudt fra strømforsyningen.
-  Apparatet er afbrudt fra vandforsyningen.

### 4.1.1 Fjernelse af topplade

- ▶ 1. Fjern skruerne (1).
- 2. Skub toppladen bagud på apparatet (2).
- 3. Bevæg toppladen opad (3) for at fjerne den.

### 4.1.2 Montering af topplade



Vær opmærksom på kabelinstallation. Kabel kan blive fanget.

- ▶ Montér i omvendt rækkefølge.

## 4.2 Udskiftning af sæbeskuffe

### Preindstilling:

- ✓ Apparatet er afbrudt fra strømforsyningen.
- ✓ Apparatet er afbrudt fra vandforsyningen.

### 4.2.1 Fjernelse af sæbeskuffe

1. Træk sæbeskuffen ud.
2. 1. Tryk ned på indsatsen (1).  
2. Fjern sæbeskuffen (2).

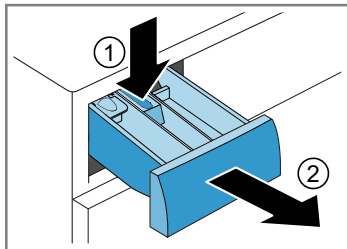

### 4.2.2 Montering af sæbeskuffe

- ▶ Montér i omvendt rækkefølge.

## 4.3 Udskiftning af sæbeskuffens håndtag

### Preindstilling:

- ✓ Apparatet er afbrudt fra strømforsyningen.
- ✓ Apparatet er afbrudt fra vandforsyningen.
- ✓ [Sæbeskuffen er fjernet.](#)→65

### 4.3.1 Fjernelse af sæbeskuffens håndtag

1. Frigør låseelementerne.

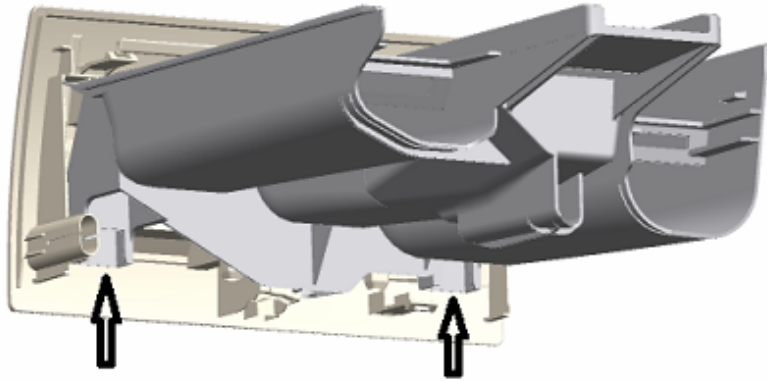





2. Fjern sæbeskuffens håndtag.

### 4.3.2 Montering af sæbeskuffens håndtag

- ▶ Montér i omvendt rækkefølge.

## 4.4 Udskiftning af betjeningspanel

Som producent er vi forpligtet til at sikre kunderne adgang til betjeningspanelet som reservedel, inklusive reparationsvejledningen, i overensstemmelse med forordning (EU) 2019/2023. Vi gør imidlertid opmærksom på, at det efter udskiftning af betjeningspanelet er nødvendigt med en elektroteknisk sikkerhedstest, der udføres af en kvalificeret elektriker, før apparatet tages i brug. Denne person skal være dokumenterbart kvalificeret i henhold til landespecifikke love, forskrifter og standarder.

	<p style="text-align: center;"><b>⚠️ FARE</b></p> <p><b>Fare for elektrisk stød pga. spændingsførende dele!</b> Livsfare pga. elektrisk stød i tilfælde af ukorrekt reparation</p> <ul style="list-style-type: none"> <li>▶ Elektriske dele skal repareres af kvalificerede elektrikere.</li> <li>▶ Få efter reparationen udført en sikkerhedstest i henhold til VDE 0701 eller landespecifikke forskrifter.</li> </ul>
	<p style="text-align: center;"><b>⚠️ ADVARSEL</b></p> <p><b>Apparater på skrå kan glide!</b> Knoglebrud/klemskader</p> <ul style="list-style-type: none"> <li>▶ Sørg for at sikre apparater mod at glide.</li> </ul>
	<p style="text-align: center;"><b>⚠️ PAS PÅ!</b></p> <p><b>Skarpe huskanter!</b> Snitlæsioner</p> <ul style="list-style-type: none"> <li>▶ Brug beskyttelseshandsker.</li> </ul>
	<p style="text-align: center;"><b>⚠️ PAS PÅ!</b></p> <p><b>Fare for nedfaldende dele pga. løsnede skruer!</b> Personskade pga. nedfaldende dele.</p> <ul style="list-style-type: none"> <li>▶ Sørg for at sikre komponenten mod at falde ned.</li> </ul>
	<p style="text-align: center;"><b>BEMÆRK!</b></p> <p><b>Fare for nedfaldende dele pga. løsnede skruer!</b> Beskadigelse af andre apparatdele eller kundens hjem, f.eks. gulvet.</p> <ul style="list-style-type: none"> <li>▶ Sørg for at sikre komponenten mod at falde ned.</li> </ul>

### Preindstilling:

- ✔️ Apparatet er afbrudt fra strømforsyningen.
- ✔️ Apparatet er afbrudt fra vandforsyningen.

✔️ [Toppladen er fjernet. →64](#)

✔️ [Sæbeskuffen er fjernet. →65](#)

### 4.4.1 Fjernelse af betjeningspanel

1. Fjern skruerne (1).
2. Frigør låseelementerne (2, 3).

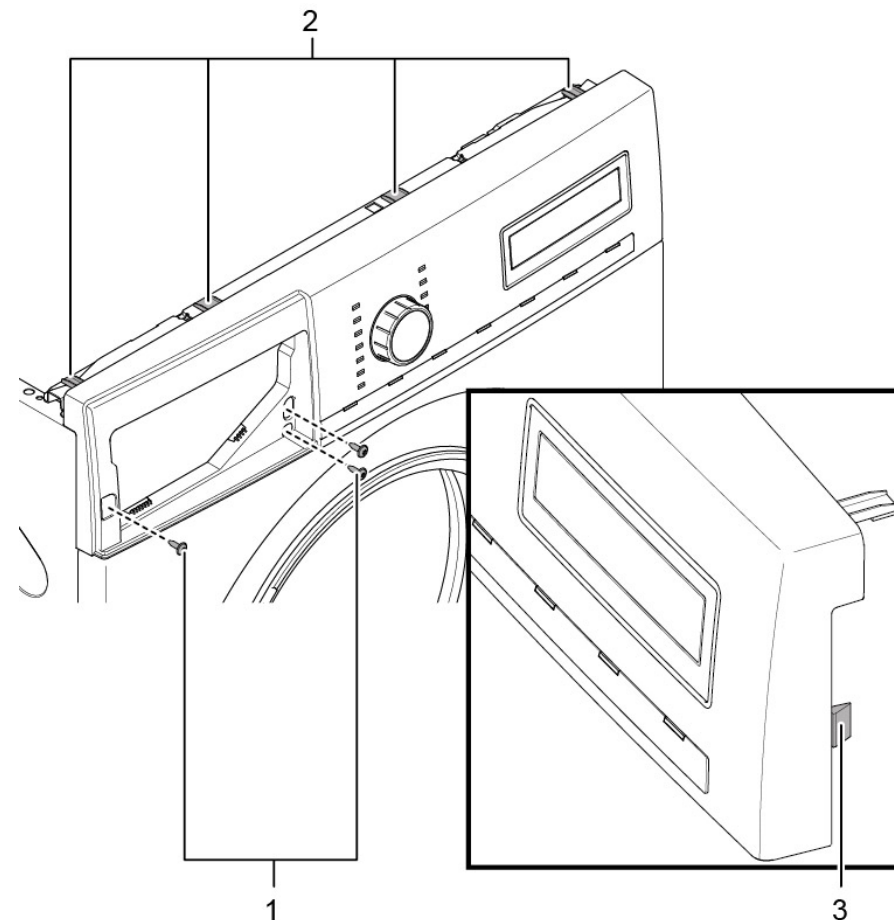

2. Frigør styreenhedens stikkontakt.
3. Fjern betjeningspanelet.

### 4.4.2 Montering af betjeningspanel



Vær opmærksom på kabelinstallation. Kabel kan blive fanget.

- ▶ Montér i omvendt rækkefølge.

## 4.5 Udskiftning af dør

	<b>⚠ PAS PÅ!</b> <b>Åbent hængselområde!</b> Fingre kan blive klemt/sætte sig fast ▶ Grib ikke ind i hængselområdet. ▶ Brug beskyttelseshandsker.
--	---

	<b>⚠ PAS PÅ!</b> <b>Fare for nedfaldende dele pga. løsnede skruer!</b> Personskade pga. nedfaldende dele. ▶ Sørg for at sikre komponenten mod at falde ned.
--	--

	<b>BEMÆRK!</b> <b>Fare for nedfaldende dele pga. løsnede skruer!</b> Beskadigelse af andre apparatdele eller kundens hjem, f.eks. gulvet. ▶ Sørg for at sikre komponenten mod at falde ned.
--	--

### Preindstilling:

- ✔ Apparatet er afbrudt fra strømforsyningen.
- ✔ Apparatet er afbrudt fra vandforsyningen.
- ✔ Døren er åben.

### 4.5.1 Fjernelse af dør

1. Fjern skruerne (1).

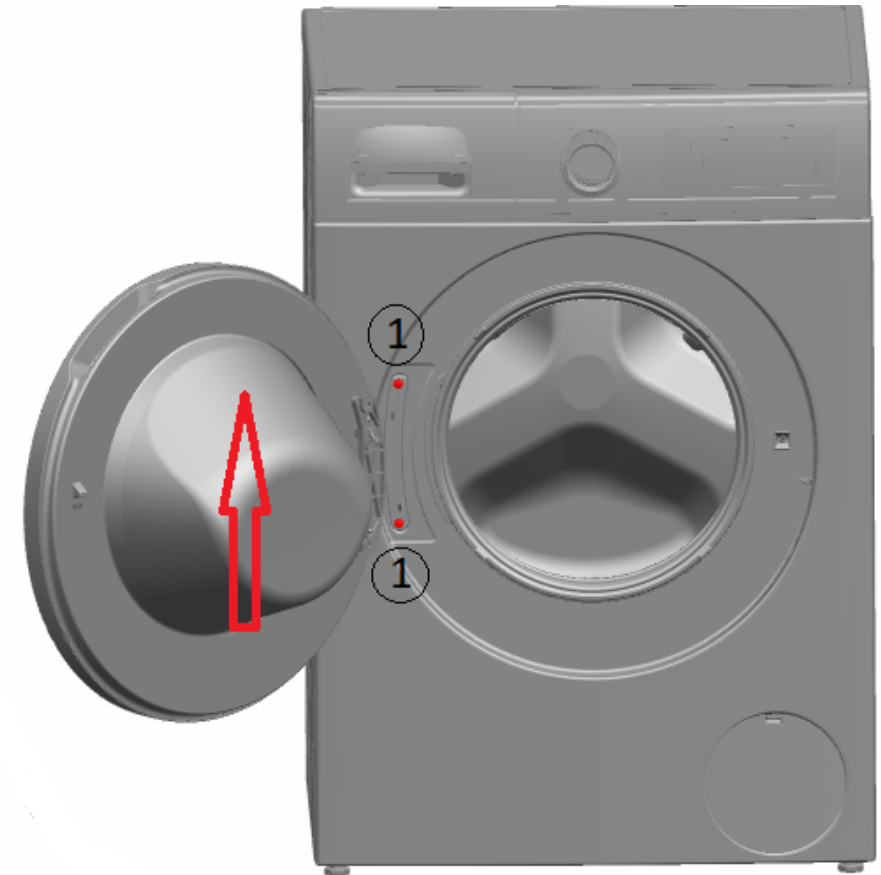



2. Fjern døren opad.

### 4.5.2 Montering af dør

- ▶ Montér i omvendt rækkefølge.

## 4.6 Udskiftning af dørkomponenter

	<b>⚠ ADVARSEL</b>
	<b>Tunge og bevægelige komponenter!</b> Fare for klemning i forbindelse med reparation, vedligeholdelse, fejlafhjælpning og service <ul style="list-style-type: none"><li>▶ Brug sikkerhedssko.</li><li>▶ Sørg for at sikre tunge komponenter mod at falde ned.</li><li>▶ Stik ikke kroppsdele ind i bevægelige komponenter.</li></ul>

	<b>⚠ PAS PÅ!</b>
	<b>Åbent hængselområde!</b> Fingre kan blive klemt/sætte sig fast <ul style="list-style-type: none"><li>▶ Grib ikke ind i hængselområdet.</li><li>▶ Brug beskyttelseshandsker.</li></ul>

### Preindstilling:

- ✓ Apparatet er afbrudt fra strømforsyningen.
- ✓ Apparatet er afbrudt fra vandforsyningen.
- ✓ [Døren er fjernet.](#) → 69

### 4.6.1 Fjernelse af dørkomponenter

- ▶ Skil døren ad udefra og ind.

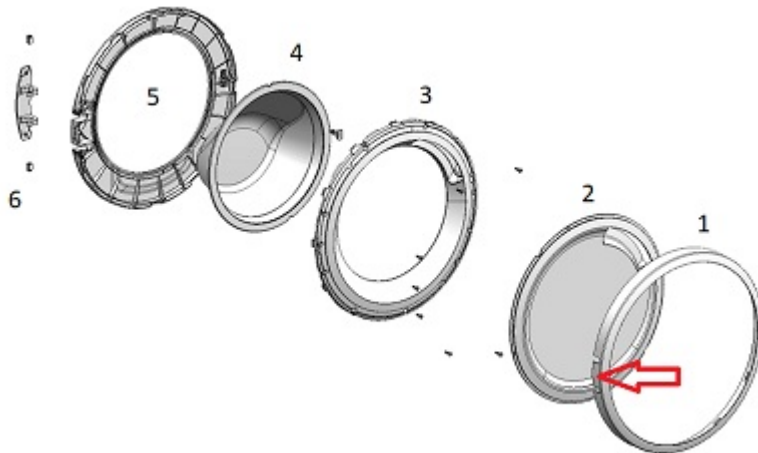

### 4.6.2 Montering af dørkomponenter

- ▶ Montér i omvendt rækkefølge.

## 4.7 Udskiftning af pumpens afdækning

### Preindstilling:

- ✓ Apparatet er afbrudt fra strømforsyningen.
- ✓ Apparatet er afbrudt fra vandforsyningen.

### 4.7.1 Fjernelse af pumpens afdækning

1. Åbn pumpens afdækning.

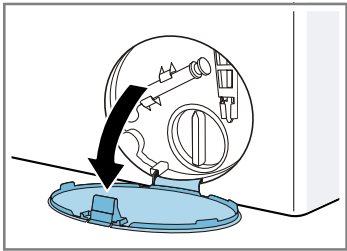

2. Fjern pumpens afdækning.

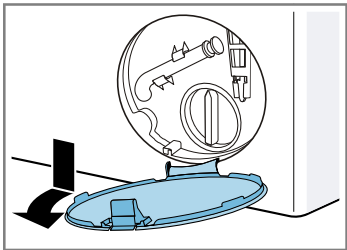



### 4.7.2 Montering af pumpens afdækning

- ▶ Montér i omvendt rækkefølge.

## 4.8 Udskiftning af dørpakning

	<b>⚠ PAS PÅ!</b> <b>Skarpe huskanter!</b> Snitlæsioner ▶ Brug beskyttelseshandsker.
--	--

	<b>⚠ PAS PÅ!</b> <b>Fare for nedfaldende dele pga. løsnede skruer!</b> Personskade pga. nedfaldende dele. ▶ Sørg for at sikre komponenten mod at falde ned.
--	--

	<b>BEMÆRK!</b> <b>Fare for nedfaldende dele pga. løsnede skruer!</b> Beskadigelse af andre apparatdele eller kundens hjem, f.eks. gulvet. ▶ Sørg for at sikre komponenten mod at falde ned.
--	--

### Preindstilling:

- ✔ Apparatet er afbrudt fra strømforsyningen.
- ✔ Apparatet er afbrudt fra vandforsyningen.
- ✔ Der er fri adgang til apparaterne.
- ✔ [Toppladen er fjernet.→64](#)
- ✔ [Sæbeskuffen er fjernet.→65](#)
- ✔ [Betjeningspanelet er fjernet.→67](#)
- ✔ [Døren er fjernet.→69](#)
- ✔ [Pumpens afdækning er fjernet.→71](#)
- ✔ [Frontpanelet er fjernet.→76](#)
- ✔ [Tromlebelysningen er fjernet \(valgfri\).→75](#)

## 4.8.1 Fjernelse af dørpakning

1. Frigør alle slangeforbindelser.

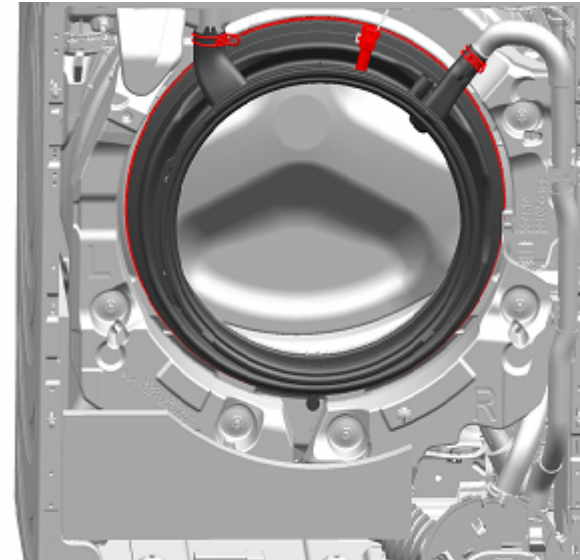

2. Fjern dørpakningen.





## 4.8.2 Montering af dørpakning

	<b>⚠ ADVARSEL</b> <b>Fare for nedfaldende dele pga. forkert installation!</b> Fare for tilskadecomst eller beskadigelse af apparatet. ▶ Spænd spænderingen på dørbælgen med 3,4 Nm.
--	--

- ▶ Monter i omvendt rækkefølge.

## 4.9 Udskiftning af dørlås

Som producent er vi forpligtet til at sikre kunderne adgang til dørlåsen som reservedel, inklusive reparationsvejledningen, i overensstemmelse med forordning (EU) 2019/2023. Vi gør imidlertid opmærksom på, at det efter udskiftning af dørlåsen er nødvendigt med en elektroteknisk sikkerhedstest, der udføres af en kvalificeret elektriker, før apparatet tages i brug. Denne person skal være dokumenterbart kvalificeret i henhold til landespecifikke love, forskrifter og standarder.

	<b>FARE</b> <b>Fare for elektrisk stød pga. spændingsførende dele!</b> Livsfare pga. elektrisk stød i tilfælde af ukorrekt reparation. <ul style="list-style-type: none"><li>▶ Elektriske dele skal repareres af kvalificerede elektrikere.</li><li>▶ Få efter reparationen udført en sikkerhedstest i henhold til VDE 0701 eller landespecifikke forskrifter.</li></ul>
	<b>ADVARSEL</b> <b>Apparater på skrå kan glide!</b> Knoglebrud/klemskader. <ul style="list-style-type: none"><li>▶ Sørg for at sikre apparater mod at glide.</li></ul>
	<b>PAS PÅ!</b> <b>Skarpe huskanter!</b> Snitlæsioner. <ul style="list-style-type: none"><li>▶ Brug beskyttelseshandsker.</li></ul>
	<b>PAS PÅ!</b> <b>Fare for nedfaldende dele pga. løsnede skruer!</b> Personskade pga. nedfaldende dele. <ul style="list-style-type: none"><li>▶ Sørg for at sikre komponenten mod at falde ned.</li></ul>
	<b>BEMÆRK!</b> <b>Fare for nedfaldende dele pga. løsnede skruer!</b> Beskadigelse af andre apparatdele eller kundens hjem, f.eks. gulvet. <ul style="list-style-type: none"><li>▶ Sørg for at sikre komponenten mod at falde ned.</li></ul>

### Preindstilling:

- ✓ Apparatet er afbrudt fra strømforsyningen.
- ✓ Apparatet er afbrudt fra vandforsyningen.

- ✓ Der er fri adgang til apparaterne.
- ✓ [Toppladen er fjernet.→64](#)
- ✓ [Sæbeskuffen er fjernet.→65](#)
- ✓ [Betjeningspanelet er fjernet.→67](#)
- ✓ [Døren er fjernet.→69](#)
- ✓ Spænderingen er fjernet.
- ✓ [Dørpakningen er fjernet.→72](#)
- ✓ [Pumpens afdækning er fjernet.→71](#)
- ✓ [Frontpanelet er fjernet.→76](#)

### 4.9.1 Fjernelse af dørlås

1. Træk dørlåsstikket ud.
2. Frigør dørlåsen.



3. Fjern dørlåsen.

### 4.9.2 Montering af dørlås

Dørlåsen skal være i den korrekte position for at sikre apparatets nød-døråbningsfunktion.

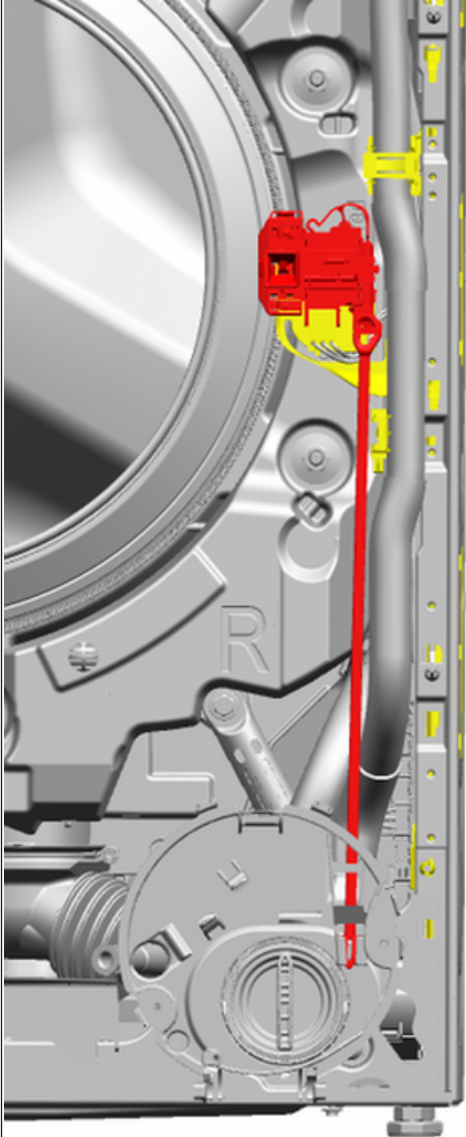



- ▶ Monter i omvendt rækkefølge.

## 4.10 Udskiftning af tromlelyns

	<b>⚠ ADVARSEL</b> <b>Apparater på skrå kan glide!</b> Knoglebrud/klemskader ▶ Sørg for at sikre apparater mod at glide.
--	--

	<b>⚠ PAS PÅ!</b> <b>Skarpe huskanter!</b> Snitlæsioner ▶ Brug beskyttelseshandsker.
--	--

	<b>⚠ PAS PÅ!</b> <b>Fare for nedfaldende dele pga. løsnede skruer!</b> Personskade pga. nedfaldende dele. ▶ Sørg for at sikre komponenten mod at falde ned.
--	--

	<b>BEMÆRK!</b> <b>Fare for nedfaldende dele pga. løsnede skruer!</b> Beskadigelse af andre apparatdele eller kundens hjem, f.eks. gulvet. ▶ Sørg for at sikre komponenten mod at falde ned.
--	--

### Preindstilling:

- ✔ Apparatet er afbrudt fra strømforsyningen.
- ✔ Apparatet er afbrudt fra vandforsyningen.
- ✔ Der er fri adgang til apparaterne.
- ✔ [Toppladen er fjernet.→64](#)
- ✔ [Sæbeskuffen er fjernet.→65](#)
- ✔ [Betjeningspanelet er fjernet.→67](#)

## 4.10.1 Fjernelse af tromlelyns

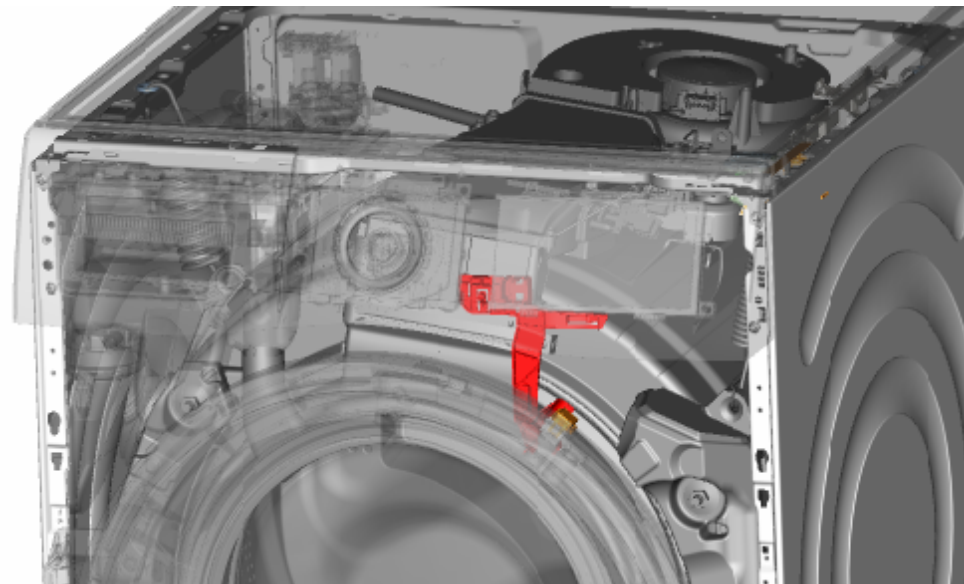

1. Træk tromlelysholderen ud af apparatet.
2. Afbryd de elektriske tilslutninger.
3. Fjern tromlelyset fra tromlelysholderen.

## 4.10.2 Montering af tromlelyse

	Vær opmærksom på kabelinstallation. Kabel kan blive fanget.
---	---

- ▶ Monter i omvendt rækkefølge.

## 4.11 Udskiftning af frontpanel



### ⚠️ ADVARSEL

Apparater på skrå kan glide!

Knoglebrud/klemskader

- ▶ Sørg for at sikre apparater mod at glide.



### ⚠️ PAS PÅ!

Skarpe huskanter!

Snitlæsioner

- ▶ Brug beskyttelseshandsker.



### ⚠️ PAS PÅ!

Fare for nedfaldende dele pga. løsnede skruer!

Personskade pga. nedfaldende dele.

- ▶ Sørg for at sikre komponenten mod at falde ned.



### BEMÆRK!

Fare for nedfaldende dele pga. løsnede skruer!

Beskadigelse af andre apparatdele eller kundens hjem, f.eks. gulvet.

- ▶ Sørg for at sikre komponenten mod at falde ned.

### Preindstilling:

- ✓ Apparatet er afbrudt fra strømforsyningen.
- ✓ Apparatet er afbrudt fra vandforsyningen.
- ✓ Der er fri adgang til apparaterne.
- ✓ [Toppladen er fjernet.→64](#)
- ✓ [Sæbeskuffen er fjernet.→65](#)
- ✓ [Betjeningspanelet er fjernet.→67](#)
- ✓ [Døren er fjernet.→69](#)
- ✓ [Pumpens afdækning er fjernet.→71](#)
- ✓ Spænderingen er fjernet.
- ✓ Dørpakningen er frigjort på fronten.
- ✓ [Tromlebelysningen er fjernet \(valgfri\).→75](#)

### 4.11.1 Fjernelse af frontpanel

1. Løft apparatet op i fronten.

2. Fjern skruerne forned (1).

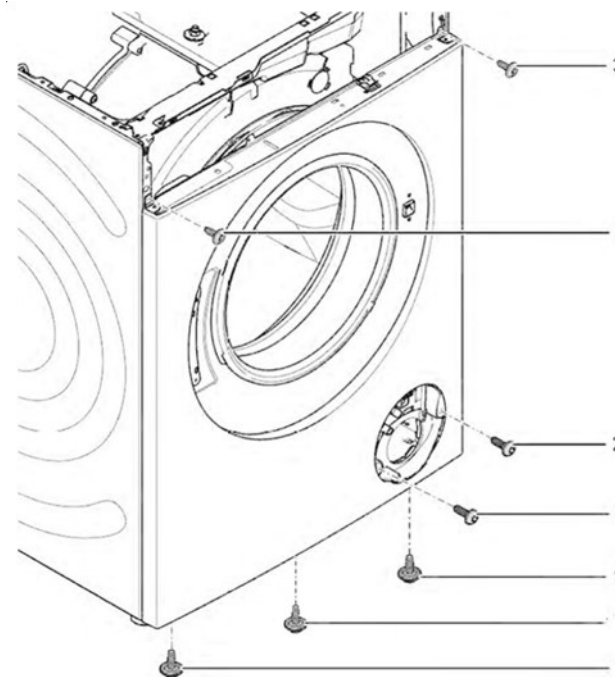

3. Sænk apparatet ned.

4. Fjern skruerne på fronten ved at starte nedefra og op (2, 3).

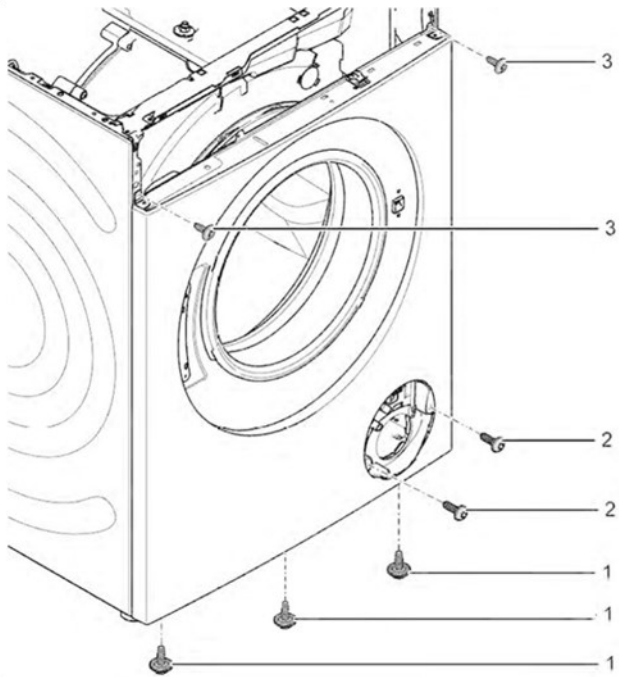





5. Fjern frontpanelet.

### 4.11.2 Montering af frontpanel

- ▶ Montér i omvendt rækkefølge.

# Reparatie informatie - Wasmachine

 <b>Over dit document</b> .....	<b>79</b>	4.8 Deurafdichting vervangen.....	91
1.1 Belangrijke informatie .....	79	4.8.1 Deurafdichting verwijderen.....	91
1.1.1 Doel .....	79	4.8.2 Deurafdichting monteren.....	91
1.2 Verklaring van symbolen.....	79	4.9 Deurslot vervangen .....	92
1.2.1 Gevarenniveaus.....	79	4.9.1 Deurslot verwijderen .....	92
1.2.2 Gevarensymbolen.....	79	4.9.2 Deurslot monteren.....	93
1.2.3 Structuur van de waarschuwingen.....	80	4.10 Trommelverlichting vervangen .....	95
1.2.4 Algemene symbolen.....	80	4.10.1 Trommelverlichting verwijderen .....	95
 <b>Veiligheid</b> .....	<b>81</b>	4.10.2 Trommelverlichting monteren .....	95
2.1 Algemene veiligheidsinstructies.....	81	4.11 Frontpaneel vervangen.....	96
2.1.1 Alle huishoudelijke apparaten .....	81	4.11.1 Frontpaneel verwijderen.....	96
 <b>Gereedschappen en hulpmiddelen</b> .....	<b>82</b>	4.11.2 Frontpaneel monteren.....	97
 <b>Reparatie</b> .....	<b>83</b>		
4.1 Werkblad vervangen.....	83		
4.1.1 Werkblad verwijderen.....	83		
4.1.2 Werkblad monteren.....	83		
4.2 Wasmiddellade vervangen .....	84		
4.2.1 Wasmiddellade verwijderen .....	84		
4.2.2 Wasmiddellade monteren .....	84		
4.3 Handgreep wasmiddellade vervangen .....	85		
4.3.1 Handgreep wasmiddellade verwijderen .....	85		
4.3.2 Handgreep wasmiddellade monteren .....	85		
4.4 Bedieningspaneel vervangen .....	86		
4.4.1 Bedieningspaneel verwijderen .....	87		
4.4.2 Bedieningspaneel monteren .....	87		
4.5 Deur vervangen.....	88		
4.5.1 Deur verwijderen.....	88		
4.5.2 Deur monteren.....	88		
4.6 Deurcomponenten vervangen .....	89		
4.6.1 Deurcomponenten verwijderen .....	89		
4.6.2 Deurcomponenten monteren .....	89		
4.7 Pompdeksel vervangen.....	90		
4.7.1 Pompdeksel verwijderen.....	90		
4.7.2 Pompdeksel monteren.....	90		

# **i** Over dit document

## 1.1 Belangrijke informatie

### 1.1.1 Doel

Met deze reparatieaanwijzingen wordt de klant geholpen zelf apparaten te repareren conform de toepasselijke verordening inzake ecologisch ontwerp (met ingang van 03/2021).



Ze bevatten informatie over hoe gedefinieerde reserveonderdelen kunnen worden vervangen met inbegrip van waarschuwingen en gevaren.

Neem bij vragen contact op met onze klantenservice. We stellen ons alleen aansprakelijk voor schade als de reparatieaanwijzingen correct zijn opgevolgd.

## 1.2 Verklaring van symbolen

### 1.2.1 Gevarenniveaus

De waarschuwningsniveaus worden aangegeven met een symbool en een signaalwoord. Het signaalwoord geeft de ernst van het gevaar aan.





Waarschuwningsniveau	Betekenis
	Als de waarschuwing niet in acht wordt genomen, leidt dat tot ernstig of dodelijk letsel.
	Als de waarschuwing niet in acht wordt genomen, kan dat tot ernstig of dodelijk letsel leiden.
	Als de waarschuwing niet in acht wordt genomen, kan dat tot licht letsel leiden.
	Als de waarschuwing niet in acht wordt genomen, kan dat tot materiële schade leiden.

Tabel 1: Gevarenniveaus

### 1.2.2 Gevarensymbolen

Gevarensymbolen zijn symbolische afbeeldingen die een indicatie geven van het soort gevaar.

De volgende gevarensymbolen worden in dit document gebruikt:

Gevarensymbool	Betekenis
	Algemene waarschuwing
	Gevaar voor elektrische spanning
	Ontploffingsgevaar
	Snijgevaar

## **i** Over dit document

Gevarensymbool	Betekenis
	Beknellingsgevaar
	Gevaar voor hete oppervlakken
	Gevaar voor sterke magnetische velden
	Gevaar voor niet-ioniserende straling

Tabel 2: Gevarensymbolen

### 1.2.3 Structuur van de waarschuwingen

Waarschuwingen in dit document hebben een gestandaardiseerd uiterlijk en een gestandaardiseerde structuur.







	<div style="background-color: red; color: white; padding: 2px; text-align: center;"><b>⚠ GEVAAR</b></div> <p><b>Soort gevaar en bron van het gevaar!</b> Mogelijke gevolgen van het negeren van het gevaar / de waarschuwing.</p> <ul style="list-style-type: none"> <li>▶ Maatregelen en verboden om het gevaar te voorkomen.</li> </ul>
--	---

In het volgende voorbeeld is een waarschuwing te zien waarmee voor een elektrische schok aan stroomvoerende onderdelen wordt gewaarschuwd. De maatregel om het gevaar te vermijden wordt vermeld.

	<div style="background-color: red; color: white; padding: 2px; text-align: center;"><b>⚠ GEVAAR</b></div> <p><b>Gevaar voor een elektrische schok aan stroomvoerende onderdelen!</b> Dood door elektrocutie</p> <ul style="list-style-type: none"> <li>▶ Haal apparaten minstens 60 seconden voor u met reparaties begint van de stroomvoorziening af.</li> </ul>
--	---

### 1.2.4 Algemene symbolen

De volgende algemene symbolen worden in dit document gebruikt:

Alg. symbool	Betekenis
	Identificatie van een speciale tip (tekst en/of afbeelding)
	Identificatie van een eenvoudige tip (tekst)
	Identificatie van een link naar een video-instructie
	Identificatie van vereiste gereedschappen
	Identificatie van vereiste voorwaarden
	Identificatie van een voorwaarde (als ..., dan ...)
	Identificatie van een resultaat
[Start]	Identificatie van een toets of knop
[00123456]	Identificatie van een materiaalnummer
Status	Identificatie van weergegeven tekst / venster (in het display van het apparaat)

Tabel 3: Algemene symbolen

## 2.1 Algemene veiligheidsinstructies

### 2.1.1 Alle huishoudelijke apparaten

#### **Gevaar voor een elektrische schok aan stroomvoerende onderdelen!**

- Fouten bij reparaties aan elektrische componenten kunnen tot een elektrische schok leiden!
- Koppel het apparaat minstens 60 seconden los van het stroomnet voordat u met de werkzaamheden begint.
- Laat na de reparatie een veiligheidstest conform VDE 0701 of de landspecifieke regelgeving uitvoeren.

#### **Gevaar voor letsel aan scherpe randen!**

- Draag veiligheidshandschoenen.

#### **Beknellingsgevaar tijdens reparatie, onderhoud, probleemoplossing en service vanwege zware en bewegende componenten**

- Draag veiligheidsschoenen.
- Beveilig zware componenten tegen vallen.
- Steek geen lichaamsdelen in bewegende componenten.







#### **Gevaar voor de veiligheid / werking van het apparaat!**





- Gebruik uitsluitend originele reserveonderdelen.

#### **Gevaar voor schade aan elektrostatisch gevoelige componenten (ESD's)!**

- Raak de modules met inbegrip van de aansluitingen en geleiderbanen niet aan.

## Gereedschappen en hulpmiddelen

Benaming	Details	Afbeeldingen
Hulpgereedschap [15000155]	Gereedschap voor loshalen uit kunststof onderdelen	
Torx T20 schroevendraaier met boorgat [00340764]	100 mm, voor schroeven met borgpen	
Momentsleutel [15000441]	Momentsleutel 20 - 100 Nm	
Sleufschroevendraaier [00340854]	Blad 3,5 mm x 0,6 mm x 100 mm, Beschermende isolatie 1000 V AC	
Sleufschroevendraaier [00340855]	Blad 5,5 mm x 1,0 mm x 125 mm, Beschermende isolatie 1000 V AC	
Naaldtang, gebogen [00341269]	Lengte 200 mm	
Zijsnijtang [00342182]	Lengte: 200 mm	



Benaming	Details	Afbeeldingen
Ring-steeksleutel [00340811]	Maat 10°mm, M6	
Combination wrench [00340814]	Maat 13°mm, M8	
Ring-steeksleutel [00340817]	Maat 17 mm, M10	
Ring-steeksleutel [15000459]	Maat 16°mm, M10	

## 4.1 Werkblad vervangen

### Speciale hulpmiddelen:

-  Torxbit TX20 met gat      Lengte 152 mm, bruikbare lengte 124 mm, 1/4" zeskantaandrijving (6,35 mm), voor schroeven met borgpen      [00341272]

### Voorwaarde:

-  Apparaat wordt van de stroomvoorziening afgehaald.
-  Apparaat wordt van de watervoorziening afgehaald.

### 4.1.1 Werkblad verwijderen

- ▶ 1. Verwijder schroeven (1).
- ▶ 2. Duw het werkblad naar de achterkant van het apparaat (2).
- ▶ 3. Beweeg het werkblad omhoog (3) om het te verwijderen.

### 4.1.2 Werkblad monteren



Let op de installatie van de kabel. De kabel kan beklemd raken.

- ▶ Monteer in omgekeerde volgorde.

## 4.2 Wasmiddellade vervangen

### Voorwaarde:

- ✔ Apparaat wordt van de stroomvoorziening afgehaald.
- ✔ Apparaat wordt van de watervoorziening afgehaald.

### 4.2.1 Wasmiddellade verwijderen

1. Trek de wasmiddellade open.
2. 1. Druk het inzetstuk (1) omlaag.  
2. Verwijder de wasmiddellade (2).

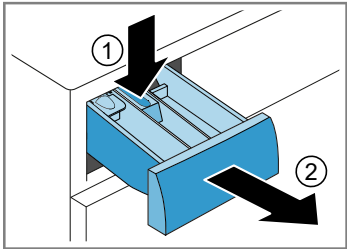

### 4.2.2 Wasmiddellade monteren

- ▶ Monteer in omgekeerde volgorde.

## 4.3 Handgreep wasmiddellade vervangen

### Voorwaarde:

- ✓ Apparaat wordt van de stroomvoorziening afgehaald.
- ✓ Apparaat wordt van de watervoorziening afgehaald.
- ✓ [Wasmiddellade is verwijderd.→84](#)

### 4.3.1 Handgreep wasmiddellade verwijderen

1. Maak vergrendelelementen los.

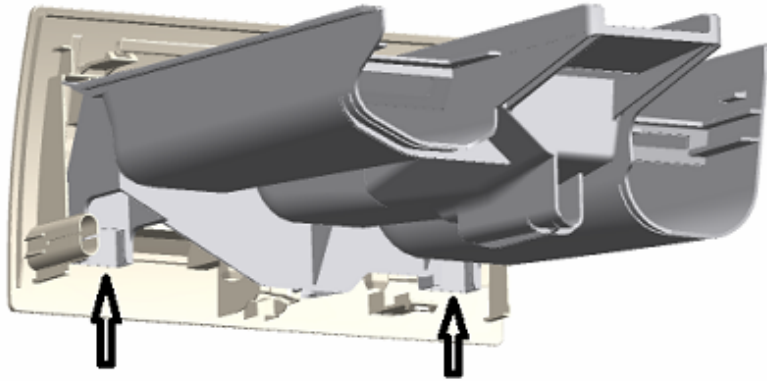

2. Verwijder de handgreep van de wasmiddellade.

### 4.3.2 Handgreep wasmiddellade monteren

- ▶ Monteer in omgekeerde volgorde.

## 4.4 Bedieningspaneel vervangen

Als fabrikant zijn wij conform Verordening (EU) 2019/2023 verplicht om consumenten het reserveonderdeel bedieningspaneel inclusief reparatie-instructies te verstrekken. Wij willen u er echter op wijzen dat na vervanging van een bedieningspaneel een elektrotechnische veiligheidstest door een gekwalificeerde elektricien is vereist voordat het apparaat in gebruik mag worden genomen. Deze persoon moet aantoonbaar gekwalificeerd zijn op grond van de landspecifieke wetten, regelgeving en normen.

	<b>⚠ GEVAAR</b>
	<b>Gevaar voor een elektrische schok aan stroomvoerende onderdelen!</b> Levensgevaar door elektrische schokken in geval van een ondeskundige reparatie <ul style="list-style-type: none"><li>▶ Elektrische onderdelen moeten door gekwalificeerde elektriciens worden gerepareerd.</li><li>▶ Laat na de reparatie een veiligheidstest conform VDE 0701 of de landspecifieke regelgeving uitvoeren.</li></ul>

	<b>⚠ WAARSCHUWING</b>
	<b>Weggliden van schuin staande apparaten!</b> Botbreuken / beknellingsletsel <ul style="list-style-type: none"><li>▶ Beveilig apparaten tegen wegglijden.</li></ul>

	<b>⚠ VOORZICHTIG</b>
	<b>Scherpe randen aan de behuizing!</b> Snijletsel <ul style="list-style-type: none"><li>▶ Draag veiligheidshandschoenen.</li></ul>

	<b>⚠ VOORZICHTIG</b>
	<b>Gevaar voor vallende onderdelen als gevolg van losgeraakte schroeven!</b> Letsel als gevolg van vallende onderdelen. <ul style="list-style-type: none"><li>▶ Beveilig component tegen vallen.</li></ul>

	<b>LET OP!</b>
	<b>Gevaar voor vallende onderdelen als gevolg van losgeraakte schroeven!</b> Schade aan andere onderdelen van het apparaat of bij de klant thuis bijvoorbeeld aan de vloer. <ul style="list-style-type: none"><li>▶ Beveilig component tegen vallen.</li></ul>

### Voorwaarde:

- ✓ Apparaat wordt van de stroomvoorziening afgehaald.
- ✓ Apparaat wordt van de watervoorziening afgehaald.
- ✓ [Werkblad is verwijderd.→83](#)
- ✓ [Wasmiddellade is verwijderd.→84](#)

## 4.4.1 Bedieningspaneel verwijderen

1. Verwijder schroeven (1).
2. Maak vergrendelelementen (2, 3) los.

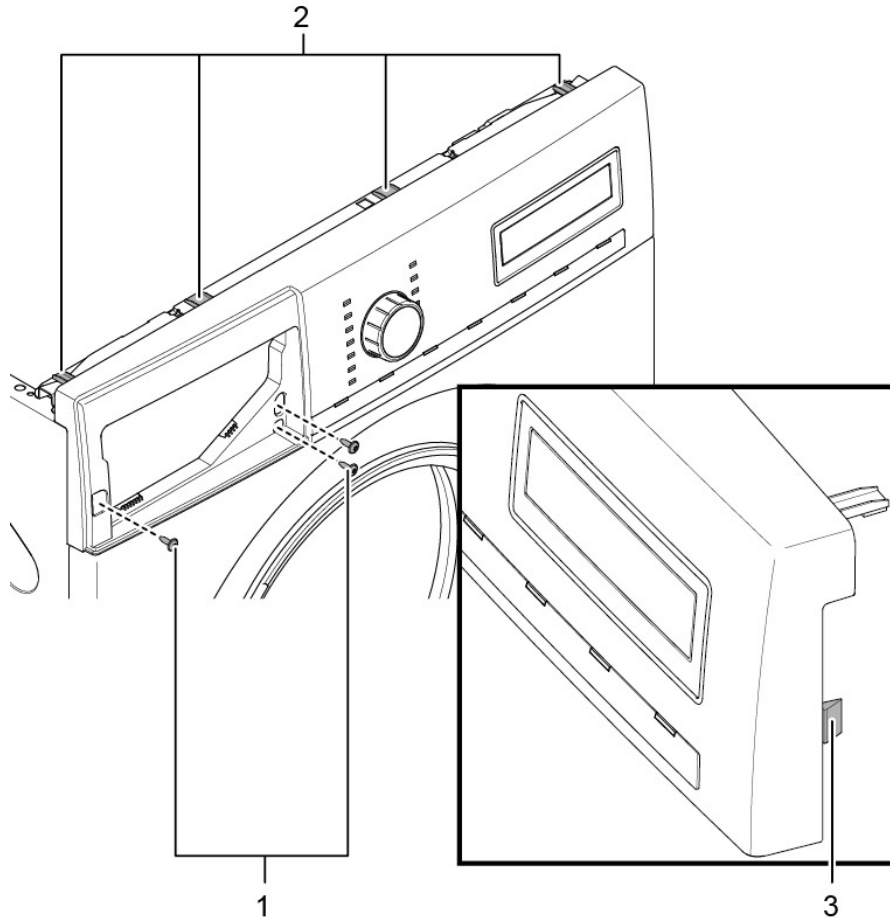

2. Haal de stekerverbinding van de bedieningseenheid los.
3. Verwijder het bedieningspaneel.

## 4.4.2 Bedieningspaneel monteren



Let op de installatie van de kabel. De kabel kan beklemd raken.

- ▶ Monteer in omgekeerde volgorde.

## 4.5 Deur vervangen

	<p><b>⚠️ VOORZICHTIG</b></p> <p><b>Maak het scharniergedeelte open!</b> Beknelling/afklemming van vingers</p> <ul style="list-style-type: none"><li>▶ Steek uw vingers niet in het scharniergedeelte.</li><li>▶ Draag veiligheidshandschoenen.</li></ul>
	<p><b>⚠️ VOORZICHTIG</b></p> <p><b>Gevaar voor vallende onderdelen als gevolg van losgeraakte schroeven!</b></p> <p>Letsel als gevolg van vallende onderdelen.</p> <ul style="list-style-type: none"><li>▶ Beveilig component tegen vallen.</li></ul>
	<p><b>LET OP!</b></p> <p><b>Gevaar voor vallende onderdelen als gevolg van losgeraakte schroeven!</b></p> <p>Schade aan andere onderdelen van het apparaat of bij de klant thuis bijvoorbeeld aan de vloer.</p> <ul style="list-style-type: none"><li>▶ Beveilig component tegen vallen.</li></ul>

### Voorwaarde:

- ✔️ Apparaat wordt van de stroomvoorziening afgehaald.
- ✔️ Apparaat wordt van de watervoorziening afgehaald.
- ✔️ Deur wordt geopend.

### 4.5.1 Deur verwijderen

1. Verwijder schroeven (1).

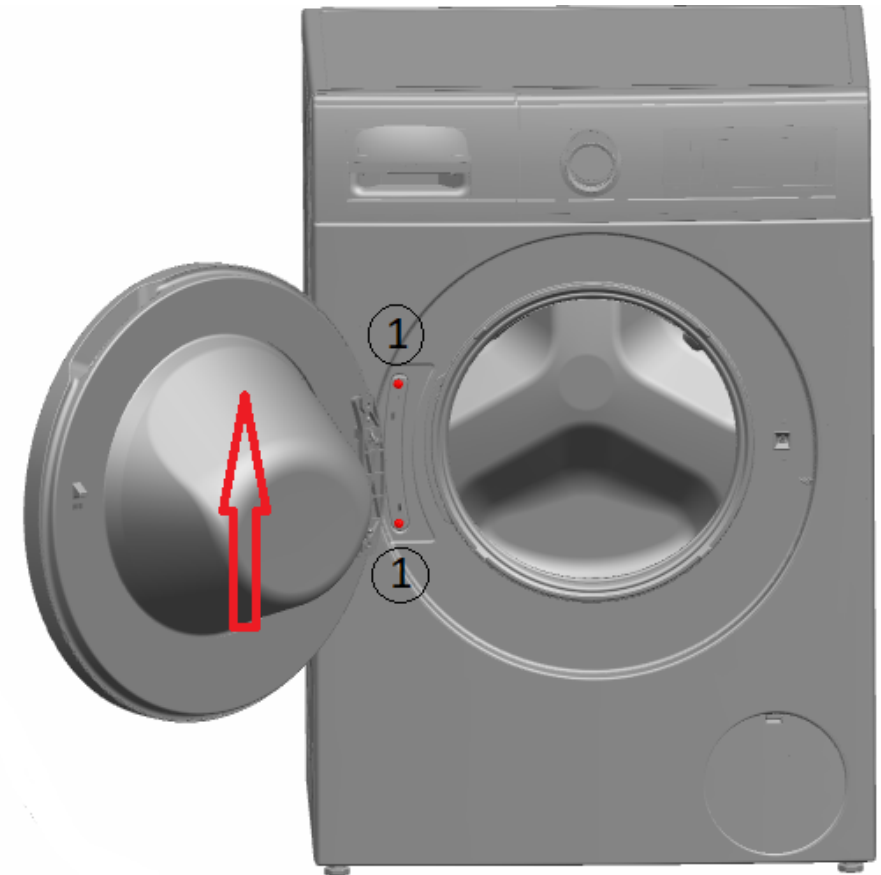

2. Verwijder deur naar boven toe.

### 4.5.2 Deur monteren

- ▶ Monteer in omgekeerde volgorde.

## 4.6 Deurcomponenten vervangen

	<b>⚠ WAARSCHUWING</b>
	<b>Zware en bewegende componenten!</b> Beknellingsgevaar tijdens reparatie, onderhoud, probleemoplossing en service <ul style="list-style-type: none"><li>▶ Draag veiligheidsschoenen.</li><li>▶ Beveilig zware componenten tegen vallen.</li><li>▶ Steek geen lichaamsdelen in bewegende componenten.</li></ul>

	<b>⚠ VOORZICHTIG</b>
	<b>Maak het scharniergedeelte open!</b> Beknelling/afklemming van vingers <ul style="list-style-type: none"><li>▶ Steek uw vingers niet in het scharniergedeelte.</li><li>▶ Draag veiligheidshandschoenen.</li></ul>

### Voorwaarde:

- ✓ Apparaat wordt van de stroomvoorziening afgehaald.
- ✓ Apparaat wordt van de watervoorziening afgehaald.
- ✓ [Deur is verwijderd.→88](#)

### 4.6.1 Deurcomponenten verwijderen

- ▶ Demonteer de deur van buiten naar binnen.

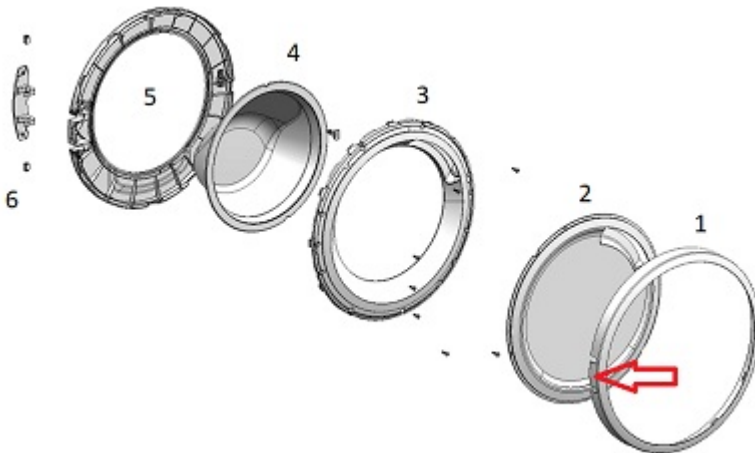

### 4.6.2 Deurcomponenten monteren

- ▶ Monteer in omgekeerde volgorde.

## 4.7 Pompdeksel vervangen

### Voorwaarde:

- ✓ Apparaat wordt van de stroomvoorziening afgehaald.
- ✓ Apparaat wordt van de watervoorziening afgehaald.

### 4.7.1 Pompdeksel verwijderen

1. Open het pompdeksel.

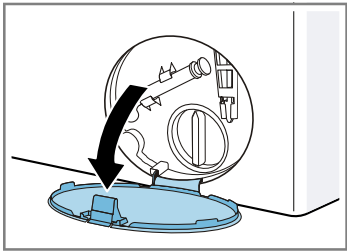

2. Verwijder het pompdeksel.

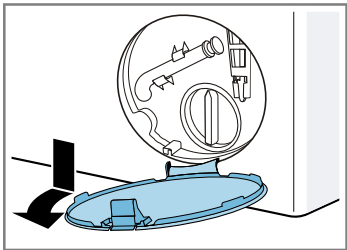

### 4.7.2 Pompdeksel monteren

- ▶ Monteer in omgekeerde volgorde.

## 4.8 Deurafdichting vervangen

	<b>⚠ VOORZICHTIG</b> <b>Scherpe randen aan de behuizing!</b> Snijletsel ▶ Draag veiligheidshandschoenen.
--	---

	<b>⚠ VOORZICHTIG</b> <b>Gevaar voor vallende onderdelen als gevolg van losgeraakte schroeven!</b> Letsel als gevolg van vallende onderdelen. ▶ Beveilig component tegen vallen.
--	--

	<b>LET OP!</b> <b>Gevaar voor vallende onderdelen als gevolg van losgeraakte schroeven!</b> Schade aan andere onderdelen van het apparaat of bij de klant thuis bijvoorbeeld aan de vloer. ▶ Beveilig component tegen vallen.
--	--

### Voorwaarde:

- ✔ Apparaat wordt van de stroomvoorziening afgehaald.
- ✔ Apparaat wordt van de watervoorziening afgehaald.
- ✔ Het apparaat is vrij toegankelijk.
- ✔ [Werkblad is verwijderd.→83](#)
- ✔ [Wasmiddellade is verwijderd.→84](#)
- ✔ [Bedieningspaneel is verwijderd.→87](#)
- ✔ [Deur is verwijderd.→88](#)
- ✔ [Pompdeksel is verwijderd.→90](#)
- ✔ [Frontpaneel is verwijderd.→96](#)
- ✔ [Trommelverlichting is verwijderd \(optioneel\).→95](#)

## 4.8.1 Deurafdichting verwijderen

1. Maak alle slangverbindingen los.

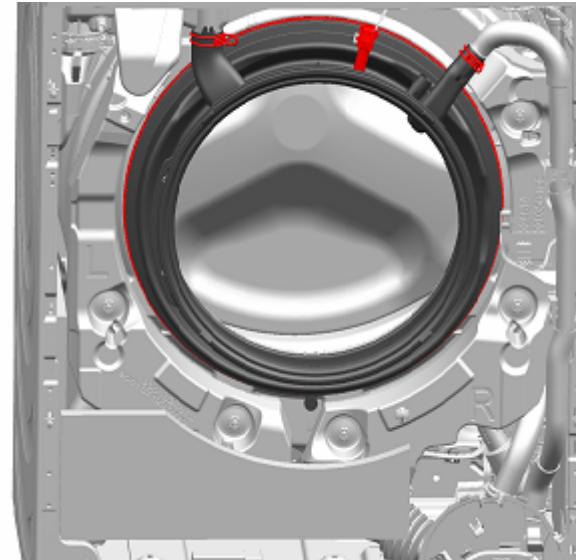

2. Verwijder de deurafdichting.

## 4.8.2 Deurafdichting monteren

	<b>⚠ WAARSCHUWING</b> <b>Gevaar voor vallende onderdelen als gevolg van onjuiste installatie!</b> Persoonlijk letsel of materiële schade aan het apparaat. ▶ Haal de spanning van de rubber manchet aan met 3,4 Nm.
--	--



- ▶ Monteer in omgekeerde volgorde.

## 4.9 Deurslot vervangen

Als fabrikant zijn wij conform Verordening (EU) 2019/2023 verplicht om consumenten het reserveonderdeel deurbeveiliging inclusief reparatie-instructies te verstrekken. Wij willen u er echter op wijzen dat na vervanging van een deurbeveiliging een elektrotechnische veiligheidstest door een gekwalificeerde elektricien is vereist voordat het apparaat in gebruik mag worden genomen. Deze persoon moet aantoonbaar gekwalificeerd zijn op grond van de landspecifieke wetten, regelgeving en normen.

	<b> GEVAAR</b>
	<p><b>Gevaar voor een elektrische schok aan stroomvoerende onderdelen!</b> Levensgevaar door elektrische schokken in geval van een ondeskundige reparatie</p> <ul style="list-style-type: none"><li>▶ Elektrische onderdelen moeten door gekwalificeerde elektriciens worden gerepareerd.</li><li>▶ Laat na de reparatie een veiligheidstest conform VDE 0701 of de landspecifieke regelgeving uitvoeren.</li></ul>

	<b> WAARSCHUWING</b>
	<p><b>Weggliden van schuin staande apparaten!</b> Botbreuken / beknellingsletsel</p> <ul style="list-style-type: none"><li>▶ Beveilig apparaten tegen wegglijden.</li></ul>

	<b> VOORZICHTIG</b>
	<p><b>Scherpe randen aan de behuizing!</b> Snijletsel</p> <ul style="list-style-type: none"><li>▶ Draag veiligheidshandschoenen.</li></ul>

	<b> VOORZICHTIG</b>
	<p><b>Gevaar voor vallende onderdelen als gevolg van losgeraakte schroeven!</b> Letsel als gevolg van vallende onderdelen.</p> <ul style="list-style-type: none"><li>▶ Beveilig component tegen vallen.</li></ul>

	<b>LET OP!</b>
	<p><b>Gevaar voor vallende onderdelen als gevolg van losgeraakte schroeven!</b> Schade aan andere onderdelen van het apparaat of bij de klant thuis bijvoorbeeld aan de vloer.</p> <ul style="list-style-type: none"><li>▶ Beveilig component tegen vallen.</li></ul>

### Voorwaarde:

- ✓ Apparaat wordt van de stroomvoorziening afgehaald.
- ✓ Apparaat wordt van de watervoorziening afgehaald.
- ✓ Het apparaat is vrij toegankelijk.
- ✓ [Werkblad is verwijderd.→83](#)
- ✓ [Wasmiddellade is verwijderd.→84](#)
- ✓ [Bedieningspaneel is verwijderd.→87](#)
- ✓ [Deur is verwijderd.→88](#)
- ✓ Spanring is verwijderd.
- ✓ [Deurafdichting is verwijderd.→91](#)
- ✓ [Pompdeksel is verwijderd.→90](#)
- ✓ [Frontpaneel is verwijderd.→96](#)

### 4.9.1 Deurslot verwijderen

1. Haal de stekker van het deurslot los.

2. Maak het deurslot los.



3. Verwijder het deurslot.

## 4.9.2 Deurslot monteren

Het deurslot moet in de juiste positie worden bevestigd om te waarborgen dat de deuropeningsfunctie in geval van nood werkt.

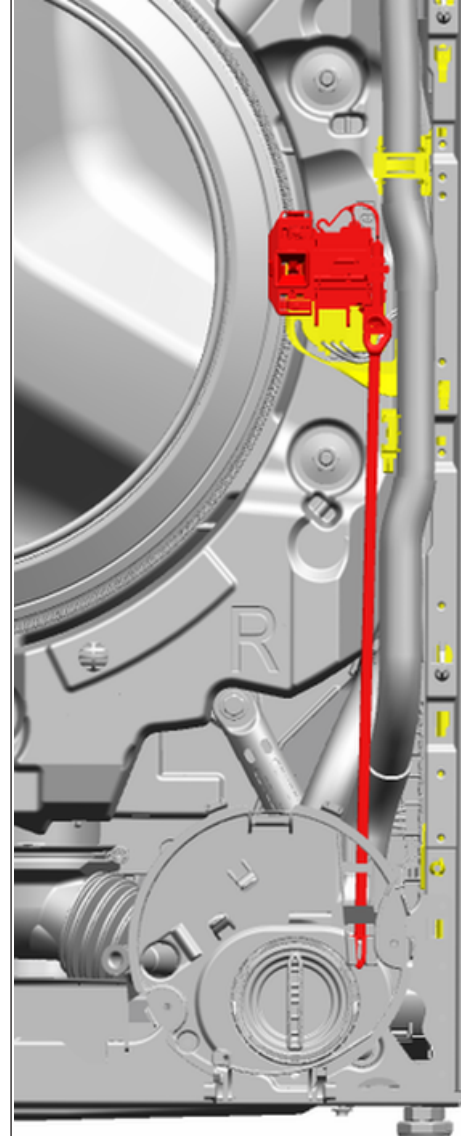

## Reparatie

- ▶ Monteer in omgekeerde volgorde.

## 4.10 Trommelverlichting vervangen



### WAARSCHUWING

**Weggliden van schuin staande apparaten!**  
Botbreuken / beknellingsletsel  
▶ Beveilig apparaten tegen wegglijden.



### VOORZICHTIG

**Scherpe randen aan de behuizing!**  
Snijletsel  
▶ Draag veiligheidshandschoenen.



### VOORZICHTIG

**Gevaar voor vallende onderdelen als gevolg van losgeraakte schroeven!**  
Letsel als gevolg van vallende onderdelen.  
▶ Beveilig component tegen vallen.



### LET OP!

**Gevaar voor vallende onderdelen als gevolg van losgeraakte schroeven!**  
Schade aan andere onderdelen van het apparaat of bij de klant thuis bijvoorbeeld aan de vloer.  
▶ Beveilig component tegen vallen.

### Voorwaarde:

- ✔ Apparaat wordt van de stroomvoorziening afgehaald.
- ✔ Apparaat wordt van de watervoorziening afgehaald.
- ✔ Het apparaat is vrij toegankelijk.
- ✔ [Werkblad is verwijderd.→83](#)
- ✔ [Wasmiddellade is verwijderd.→84](#)
- ✔ [Bedieningspaneel is verwijderd.→87](#)

## 4.10.1 Trommelverlichting verwijderen

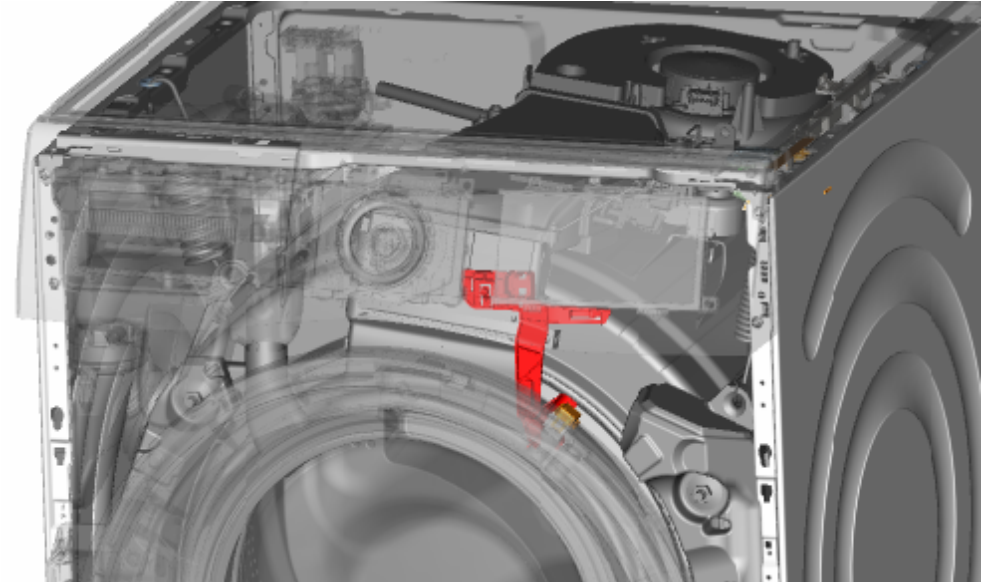

1. Trek de houder van de trommelverlichting uit het apparaat.
2. Haal de elektrische verbindingen los.
3. Haal de trommelverlichting uit de houder.

## 4.10.2 Trommelverlichting monteren



Let op de installatie van de kabel. De kabel kan beklemd raken.

- ▶ Monteer in omgekeerde volgorde.

## 4.11 Frontpaneel vervangen



### WAARSCHUWING

**Weggliden van schuin staande apparaten!**  
Botbreuken / beknellingsletsel  
▶ Beveilig apparaten tegen wegglijden.



### VOORZICHTIG

**Scherpe randen aan de behuizing!**  
Snijletsel  
▶ Draag veiligheidshandschoenen.



### VOORZICHTIG

**Gevaar voor vallende onderdelen als gevolg van losgeraakte schroeven!**  
Letsel als gevolg van vallende onderdelen.  
▶ Beveilig component tegen vallen.



### LET OP!

**Gevaar voor vallende onderdelen als gevolg van losgeraakte schroeven!**  
Schade aan andere onderdelen van het apparaat of bij de klant thuis bijvoorbeeld aan de vloer.  
▶ Beveilig component tegen vallen.

### Voorwaarde:

- ✓ Apparaat wordt van de stroomvoorziening afgehaald.
- ✓ Apparaat wordt van de watervoorziening afgehaald.
- ✓ Het apparaat is vrij toegankelijk.
- ✓ [Werkblad is verwijderd.→83](#)
- ✓ [Wasmiddellade is verwijderd.→84](#)
- ✓ [Bedieningspaneel is verwijderd.→87](#)
- ✓ [Deur is verwijderd.→88](#)
- ✓ [Pompdeksel is verwijderd.→90](#)
- ✓ Spanring is verwijderd.
- ✓ Deurafdichting is van voren losgehaald.
- ✓ [Trommelverlichting is verwijderd \(optioneel\).→95](#)

### 4.11.1 Frontpaneel verwijderen

1. Til het apparaat aan de voorkant op.
2. Verwijder de schroeven onderaan (1).

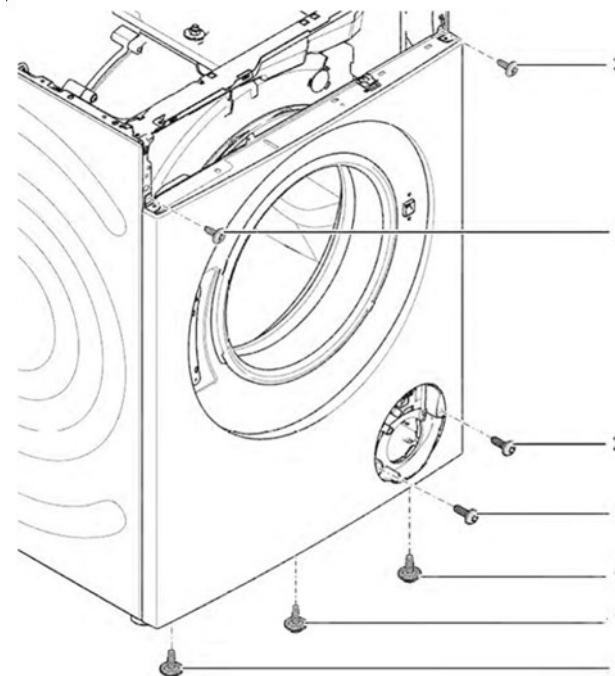

3. Laat het apparaat weer zakken.

4. Verwijder de schroeven aan de voorkant van beneden naar boven (2, 3).

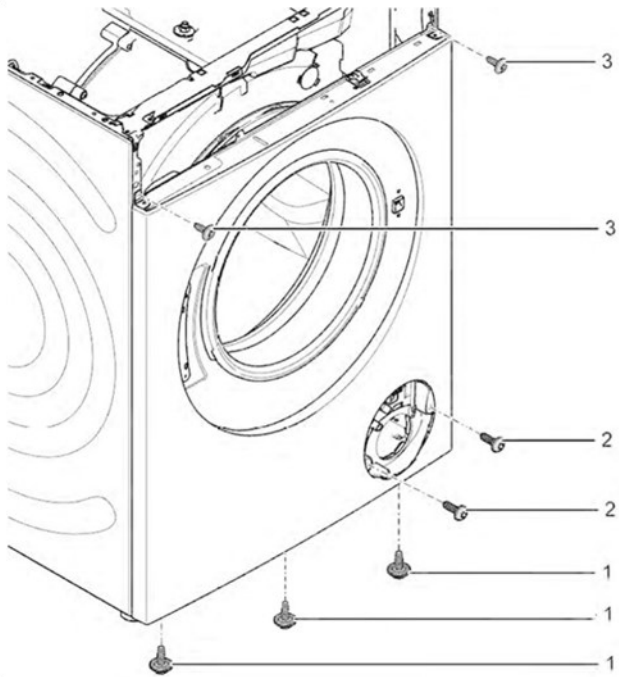





5. Verwijder het frontpaneel.

### 4.11.2 Frontpaneel monteren

- ▶ Monteer in omgekeerde volgorde.

# Self-repair hints - Washing machine

 <b>Concerning this document</b> .....	<b>99</b>
1.1 Important information .....	99
1.1.1 Purpose.....	99
1.2 Explanation of symbols .....	99
1.2.1 Danger levels.....	99
1.2.2 Hazard symbols .....	99
1.2.3 Structure of the warnings.....	100
1.2.4 General symbols.....	100
 <b>Safety</b> .....	<b>101</b>
2.1 General Safety instructions .....	101
2.1.1 All domestic appliances .....	101
 <b>Tools and aids</b> .....	<b>102</b>
 <b>Repair</b> .....	<b>103</b>
4.1 Replacing worktop .....	103
4.1.1 Removing worktop .....	103
4.1.2 Installing worktop .....	103
4.2 Replacing detergent drawer .....	104
4.2.1 Removing detergent drawer.....	104
4.2.2 Installing detergent drawer.....	104
4.3 Replacing detergent drawer handle .....	105
4.3.1 Removing detergent drawer handle.....	105
4.3.2 Installing detergent drawer handle.....	105
4.4 Replacing fascia panel.....	106
4.4.1 Removing fascia panel .....	106
4.4.2 Installing fascia panel .....	107
4.5 Replacing door .....	108
4.5.1 Removing door .....	108
4.5.2 Installing door .....	108
4.6 Replacing door components.....	109
4.6.1 Removing door components .....	109
4.6.2 Installing door components .....	109
4.7 Replacing pump cover .....	110
4.7.1 Removing pump cover.....	110
4.7.2 Installing pump cover .....	110

4.8 Replacing door seal .....	111
4.8.1 Removing door seal.....	111
4.8.2 Installing door seal.....	111
4.9 Replacing door lock.....	112
4.9.1 Removing door lock.....	112
4.9.2 Installing door lock.....	113
4.10 Replacing drum light .....	114
4.10.1 Removing drum light.....	114
4.10.2 Installing drum light.....	114
4.11 Replacing front panel .....	115
4.11.1 Removing front panel.....	115
4.11.2 Installing front panel.....	116

# **i** Concerning this document

## 1.1 Important information

### 1.1.1 Purpose

These repair hints support consumer to repair appliances by himself according to the applicable eco-design regulation (as of 03/2021).

They contain information how to exchange defined spare parts including warnings and risks.

In case of questions, please contact our customer service. We will only be liable for damages if the repair hints have been followed properly.

## 1.2 Explanation of symbols

### 1.2.1 Danger levels

The warning levels consist of a symbol and a signal word. The signal word indicates the severity of the danger.









Warning level	Meaning
	Non-observance of the warning message will result in death or serious injuries.
	Non-observance of the warning message could result in death or serious injuries.
	Non-observance of the warning message could result in minor injuries.
	Non-observance of the warning message could result in damage to property.

Table 1: Danger levels

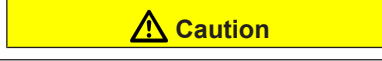
### 1.2.2 Hazard symbols

Hazard symbols are symbolic representations which give an indication of the kind of danger.

The following hazard symbols are used in this document:

Hazard symbol	Meaning
	General warning message
	Danger from electrical voltage
	Risk of explosion
	Danger of cuts
	Danger of crushing

## **i** Concerning this document



Hazard symbol	Meaning
	Danger from hot surfaces
	Danger from strong magnetic field
	Danger from non-ionizing radiation

Table 2: Hazard symbols

### 1.2.3 Structure of the warnings

Warnings in this document have a standardised appearance and a standardised structure.



	<div style="background-color: red; color: white; padding: 2px; display: inline-block;"> <b>Danger</b></div> <b>Type and source of danger!</b> Possible consequences of ignoring the danger / warning. ▶ Measures and prohibitions for preventing the danger.
--	--

The following example shows a warning that warns against electric shock due to live parts. The measure for avoiding the danger is mentioned.

	<div style="background-color: red; color: white; padding: 2px; display: inline-block;"> <b>Danger</b></div> <b>Risk of electric shock due to live parts!</b> Death by electrocution ▶ Disconnect appliances from electrical supply at least 60 seconds before starting repairs.
---	--

### 1.2.4 General symbols

The following general symbols are used in this document:

Gen. symbol	Meaning
	Identification of a special tip (text and/or graphic)
	Identification of a simple tip (only text)
	Identification of a link to a video tutorial





Gen. symbol	Meaning
	Identification of required tools
	Identification of required preconditions
	Identification of a condition (if ..., then ...)
	Identification of a result
[Start]	Identification of a key or button
[00123456]	Identification of a material number
Status	Identification of displayed text / window (in the appliance's display)

Table 3: General symbols

## 2.1 General Safety instructions

### 2.1.1 All domestic appliances

#### **Risk of electric shock due to live parts!**

- Errors by repairs involving electrical components can lead to electrical shock!
- Disconnect the appliance from the mains for at least 60 seconds before starting work.
- After the repair have a safety test according VDE 0701 or country-specific regulations performed.

#### **Risk of injury from sharp edges!**

- Wear protective gloves.

#### **Risk of crushing during repair, maintenance, troubleshooting and service due to heavy and moving components**

- Wear protective shoes.
- Secure heavy components from falling down.
- Do not stick body parts into moving components.







#### **Risk to the appliance's safety / function!**





- Only use original spare parts.

#### **Risk of damage to electrostatically sensitive components (ESDs)!**

- Do not touch the modules, including connections and conductor paths.

## Tools and aids

Designation	Details	Images
Auxiliary tool [15000155]	Tool for loosening out of plastic parts	
Screwdriver Torx T20 with bore hole [00340764]	100 mm, for screws with safety pin	
Torque spanner [15000441]	Torque spanner 20 - 100 Nm	
Slot screwdriver [00340854]	Blade 3.5 mm x 0.6 mm x 100 mm, Protective Insulation 1000 V AC	
Slot screwdriver [00340855]	Blade 5.5 mm x 1.0 mm x 125 mm, Protective Insulation 1000 V AC	
Needle-nose pliers, angled pattern [00341269]	Length 200 mm	
Side-cutting pliers [00342182]	Length: 200 mm	



Designation	Details	Images
Combination wrench [00340811]	Wrench size 10°mm, M6	
Combination wrench [00340814]	Wrench size 13°mm, M8	
Combination wrench [00340817]	Wrench size 17 mm, M10	
Combination wrench [15000459]	Wrench size 16°mm, M10	

## 4.1 Replacing worktop

### Required tools:

-  Torx Bit TX20 with hole Length 152 mm, usable length 124 mm, 1/4" hexagon drive (6.35 mm), for screws with safety pin [00341272]

### Prerequisite:

-  Appliance is disconnected from power supply.
-  Appliance is disconnected from water supply.

### 4.1.1 Removing worktop

- ▶ 1. Remove screws (1).
- ▶ 2. Push worktop to the back of the appliance (2).
- ▶ 3. Move worktop upwards (3) to remove it.

### 4.1.2 Installing worktop



Observe cable installation. Cable could be trapped.

- ▶ Install in reverse order.

## 4.2 Replacing detergent drawer

### Prerequisite:

- ✔ Appliance is disconnected from power supply.
- ✔ Appliance is disconnected from water supply.

### 4.2.1 Removing detergent drawer

1. Pull out detergent drawer.
2.
  1. Press down on insert (1).
  2. Remove detergent drawer (2).

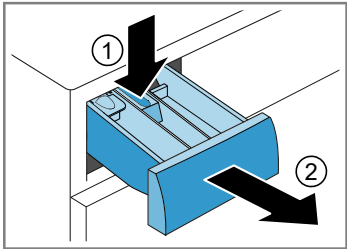

### 4.2.2 Installing detergent drawer

- ▶ Install in reverse order.

## 4.3 Replacing detergent drawer handle

### Prerequisite:

- ✓ Appliance is disconnected from power supply.
- ✓ Appliance is disconnected from water supply.
- ✓ [Detergent drawer has been removed.](#) → [Page 104](#)

### 4.3.1 Removing detergent drawer handle

1. Release catch elements.

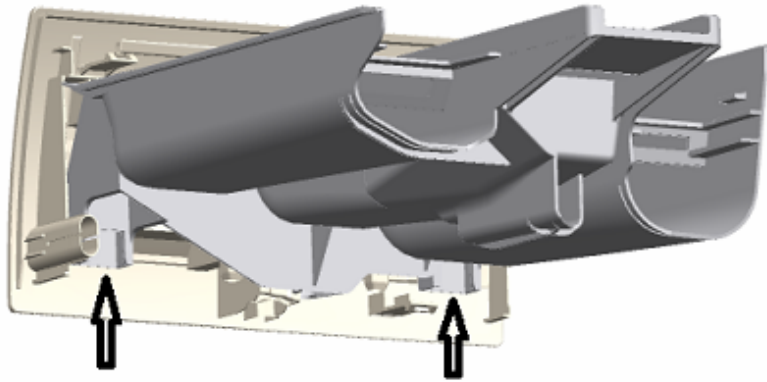





2. Remove detergent drawer handle.

### 4.3.2 Installing detergent drawer handle

- ▶ Install in reverse order.

## 4.4 Replacing fascia panel

As a manufacturer, we are obliged to provide consumers with the spare part fascia panel including repair instructions in accordance with Regulation (EU) 2019/2023. However, we would like to point out that after replacing a fascia panel, an electrotechnical safety test by a qualified electrician is required before the device is put into operation. This person must be verifiably qualified according to the country-specific laws, regulations and standards.

	<p style="text-align: center;"><b>Danger</b></p> <p><b>Risk of electric shock due to live parts!</b>            Danger to life through electric shock in case of improper repair</p> <ul style="list-style-type: none"> <li>▶ Electric parts should be repaired by a qualified electricians.</li> <li>▶ After the repair have a safety test according VDE 0701 or country-specific regulations performed.</li> </ul>
	<p style="text-align: center;"><b>Warning</b></p> <p><b>Slipping of tilted appliances!</b>            Bone fractures / crush injuries</p> <ul style="list-style-type: none"> <li>▶ Secure appliances against slipping.</li> </ul>
	<p style="text-align: center;"><b>Caution</b></p> <p><b>Sharp housing edges!</b>            Cut injuries</p> <ul style="list-style-type: none"> <li>▶ Wear protective gloves.</li> </ul>
	<p style="text-align: center;"><b>Caution</b></p> <p><b>Risk of falling parts due to released screws!</b>            Injury because of falling parts.</p> <ul style="list-style-type: none"> <li>▶ Secure component from falling down.</li> </ul>
	<p style="text-align: center;"><b>Notice</b></p> <p><b>Risk of falling parts due to released screws!</b>            Damage to other parts of the appliance or at customers home e.g. bottom.</p> <ul style="list-style-type: none"> <li>▶ Secure component from falling down.</li> </ul>

### Prerequisite:

- ✓ Appliance is disconnected from power supply.
- ✓ Appliance is disconnected from water supply.

✓ [Worktop has been removed.→ Page 103](#)

✓ [Detergent drawer has been removed.→ Page 104](#)

### 4.4.1 Removing fascia panel

1. Remove screws (1).
2. Release catch elements (2, 3).

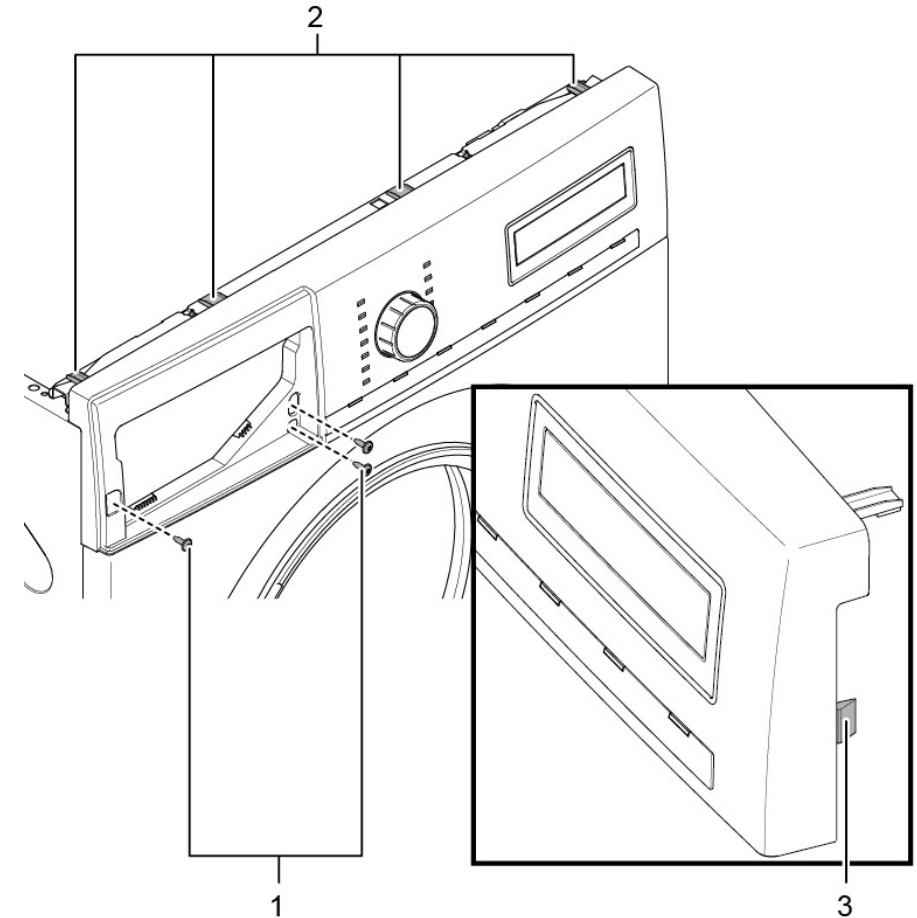

2. Release plug contact of control unit.
3. Remove fascia panel.

#### 4.4.2 Installing fascia panel





Observe cable installation. Cable could be trapped.

- ▶ Install in reverse order.

## 4.5 Replacing door

	<p><b>⚠ Caution</b></p> <p><b>Open hinge area!</b> Finger crushing / entrapment</p> <ul style="list-style-type: none"><li>▶ Do not reach into the hinge area.</li><li>▶ Wear protective gloves.</li></ul>
--	---

	<p><b>⚠ Caution</b></p> <p><b>Risk of falling parts due to released screws!</b> Injury because of falling parts.</p> <ul style="list-style-type: none"><li>▶ Secure component from falling down.</li></ul>
--	--

	<p><b>Notice</b></p> <p><b>Risk of falling parts due to released screws!</b> Damage to other parts of the appliance or at customers home e.g. bottom.</p> <ul style="list-style-type: none"><li>▶ Secure component from falling down.</li></ul>
--	---

### Prerequisite:

- ✔ Appliance is disconnected from power supply.
- ✔ Appliance is disconnected from water supply.
- ✔ Door is opened.

### 4.5.1 Removing door

1. Remove screws (1).

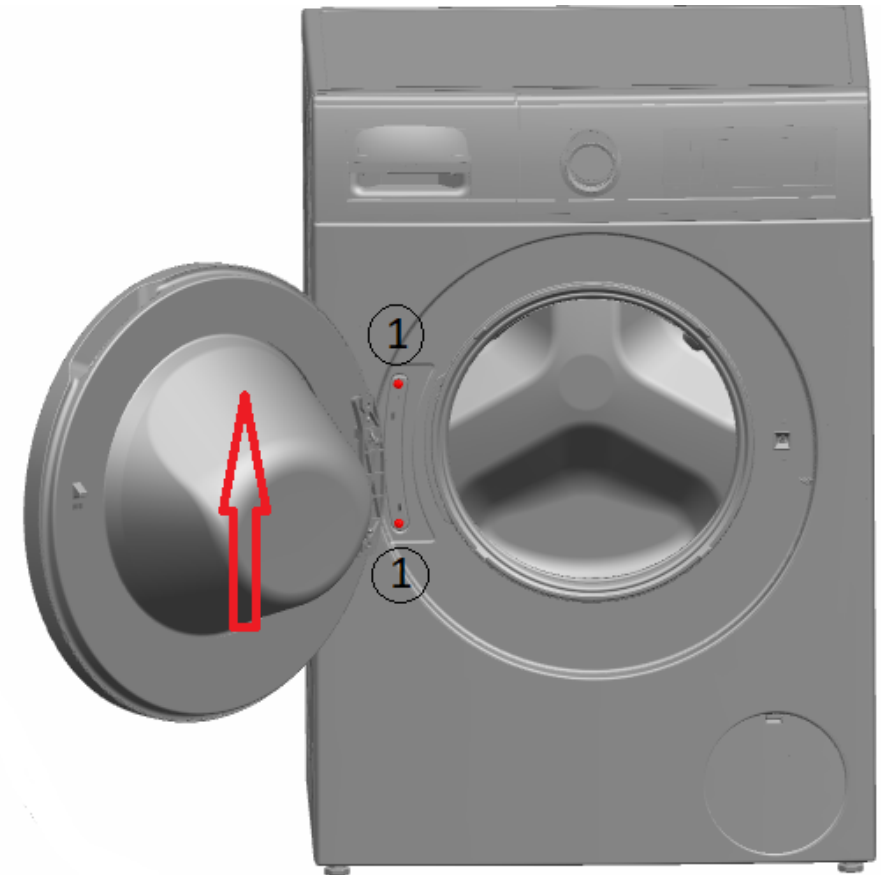

2. Remove door upwards.

### 4.5.2 Installing door

- ▶ Install in reverse order.

## 4.6 Replacing door components

	<b>Warning</b>
	<b>Heavy and moving components!</b> Risk of crushing during repair, maintenance, troubleshooting and service <ul style="list-style-type: none"><li>▶ Wear protective shoes.</li><li>▶ Secure heavy components from falling down.</li><li>▶ Do not stick body parts into moving components.</li></ul>

	<b>Caution</b>
	<b>Open hinge area!</b> Finger crushing / entrapment <ul style="list-style-type: none"><li>▶ Do not reach into the hinge area.</li><li>▶ Wear protective gloves.</li></ul>

### Prerequisite:

- ✔ Appliance is disconnected from power supply.
- ✔ Appliance is disconnected from water supply.
- ✔ [Door has been removed.](#) → [Page 108](#)

### 4.6.1 Removing door components

- ▶ Disassemble door from outside to inside.

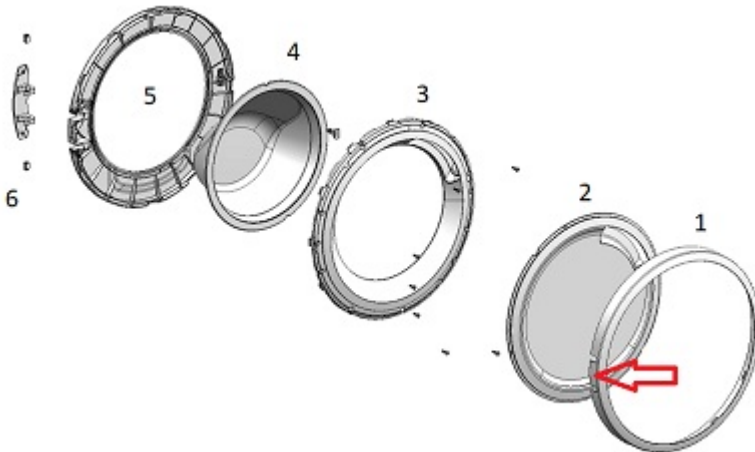

### 4.6.2 Installing door components

- ▶ Install in reverse order.

## 4.7 Replacing pump cover

### Prerequisite:

- ✓ Appliance is disconnected from power supply.
- ✓ Appliance is disconnected from water supply.

### 4.7.1 Removing pump cover

1. Open pump cover.

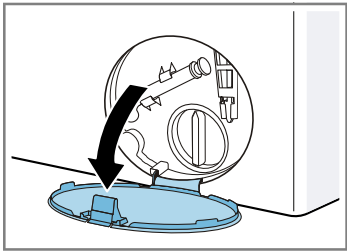

2. Remove pump cover.

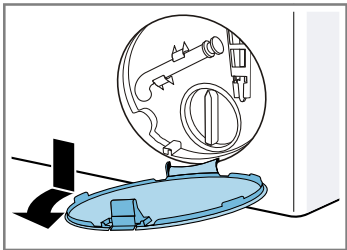



### 4.7.2 Installing pump cover

- ▶ Install in reverse order.

## 4.8 Replacing door seal

	<p><b>Caution</b></p> <p><b>Sharp housing edges!</b> Cut injuries</p> <ul style="list-style-type: none"><li>▶ Wear protective gloves.</li></ul>
--	---

	<p><b>Caution</b></p> <p><b>Risk of falling parts due to released screws!</b> Injury because of falling parts.</p> <ul style="list-style-type: none"><li>▶ Secure component from falling down.</li></ul>
--	--

	<p><b>Notice</b></p> <p><b>Risk of falling parts due to released screws!</b> Damage to other parts of the appliance or at customers home e.g. bottom.</p> <ul style="list-style-type: none"><li>▶ Secure component from falling down.</li></ul>
--	---

### Prerequisite:

- ✓ Appliance is disconnected from power supply.
- ✓ Appliance is disconnected from water supply.
- ✓ Appliances is freely accessible.
- ✓ [Worktop has been removed.→ Page 103](#)
- ✓ [Detergent drawer has been removed.→ Page 104](#)
- ✓ [Fascia panel has been removed.→ Page 106](#)
- ✓ [Door has been removed.→ Page 108](#)
- ✓ [Pump cover has been removed.→ Page 110](#)
- ✓ [Front panel has been removed.→ Page 115](#)
- ✓ [Drum light has been removed \(optional\).→ Page 114](#)

### 4.8.1 Removing door seal

1. Release all hose connections.

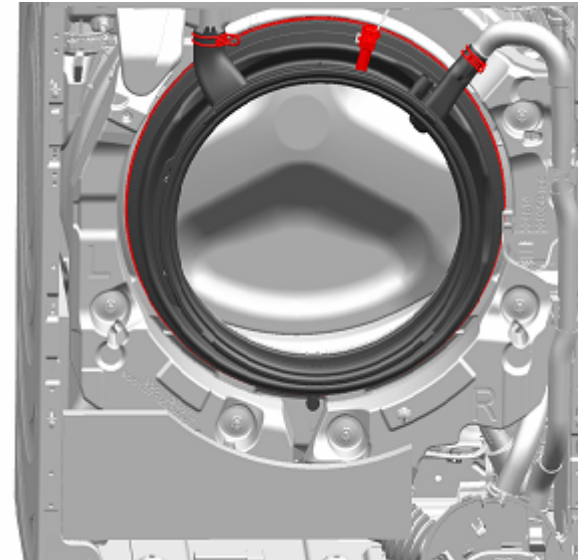

2. Remove door seal.





### 4.8.2 Installing door seal

	<p><b>Warning</b></p> <p><b>Risk of falling parts due to incorrect installation!</b> Injury or damage to the appliance.</p> <ul style="list-style-type: none"><li>▶ Tighten tension ring of boot gasket with 3,4 Nm.</li></ul>
--	--

- ▶ Install in reverse order.

## 4.9 Replacing door lock

As a manufacturer, we are obliged to provide consumers with the spare part door lock including repair instructions in accordance with Regulation (EU) 2019/2023. However, we would like to point out that after replacing a door lock, an electrotechnical safety test by a qualified electrician is required before the device is put into operation. This person must be verifiably qualified according to the country-specific laws, regulations and standards.

	<p style="text-align: center;"><b>Danger</b></p> <p><b>Risk of electric shock due to live parts!</b>            Danger to life through electric shock in case of improper repair</p> <ul style="list-style-type: none"> <li>▶ Electric parts should be repaired by a qualified electricians.</li> <li>▶ After the repair have a safety test according VDE 0701 or country-specific regulations performed.</li> </ul>
	<p style="text-align: center;"><b>Warning</b></p> <p><b>Slipping of tilted appliances!</b>            Bone fractures / crush injuries</p> <ul style="list-style-type: none"> <li>▶ Secure appliances against slipping.</li> </ul>
	<p style="text-align: center;"><b>Caution</b></p> <p><b>Sharp housing edges!</b>            Cut injuries</p> <ul style="list-style-type: none"> <li>▶ Wear protective gloves.</li> </ul>
	<p style="text-align: center;"><b>Caution</b></p> <p><b>Risk of falling parts due to released screws!</b>            Injury because of falling parts.</p> <ul style="list-style-type: none"> <li>▶ Secure component from falling down.</li> </ul>
	<p style="text-align: center;"><b>Notice</b></p> <p><b>Risk of falling parts due to released screws!</b>            Damage to other parts of the appliance or at customers home e.g. bottom.</p> <ul style="list-style-type: none"> <li>▶ Secure component from falling down.</li> </ul>

### Prerequisite:

- ✓ Appliance is disconnected from power supply.
- ✓ Appliance is disconnected from water supply.

- ✓ Appliances is freely accessible.
- ✓ [Worktop has been removed.→ Page 103](#)
- ✓ [Detergent drawer has been removed.→ Page 104](#)
- ✓ [Fascia panel has been removed.→ Page 106](#)
- ✓ [Door has been removed.→ Page 108](#)
- ✓ Tension ring has been removed.
- ✓ [Door seal has been removed.→ Page 111](#)
- ✓ [Pump cover has been removed.→ Page 110](#)
- ✓ [Front panel has been removed.→ Page 115](#)

### 4.9.1 Removing door lock

1. Disconnect door lock plug.
2. Release door lock.



3. Remove door lock.



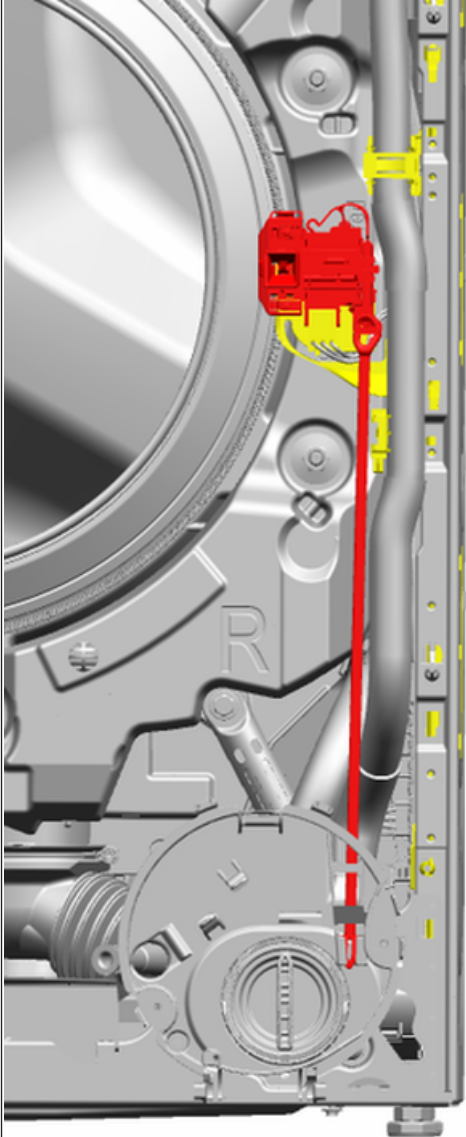

## 4.9.2 Installing door lock

Door lock must be in the right position to ensure the emergency door opening function of the appliance.



- ▶ Install in reverse order.

## 4.10 Replacing drum light

	<p><b>Warning</b></p> <p><b>Slipping of tilted appliances!</b> Bone fractures / crush injuries</p> <ul style="list-style-type: none"> <li>▶ Secure appliances against slipping.</li> </ul>
	<p><b>Caution</b></p> <p><b>Sharp housing edges!</b> Cut injuries</p> <ul style="list-style-type: none"> <li>▶ Wear protective gloves.</li> </ul>
	<p><b>Caution</b></p> <p><b>Risk of falling parts due to released screws!</b> Injury because of falling parts.</p> <ul style="list-style-type: none"> <li>▶ Secure component from falling down.</li> </ul>
	<p><b>Notice</b></p> <p><b>Risk of falling parts due to released screws!</b> Damage to other parts of the appliance or at customers home e.g. bottom.</p> <ul style="list-style-type: none"> <li>▶ Secure component from falling down.</li> </ul>

### Prerequisite:

- ✔ Appliance is disconnected from power supply.
- ✔ Appliance is disconnected from water supply.
- ✔ Appliances is freely accessible.
- ✔ [Worktop has been removed.→ Page 103](#)
- ✔ [Detergent drawer has been removed.→ Page 104](#)
- ✔ [Fascia panel has been removed.→ Page 106](#)

### 4.10.1 Removing drum light

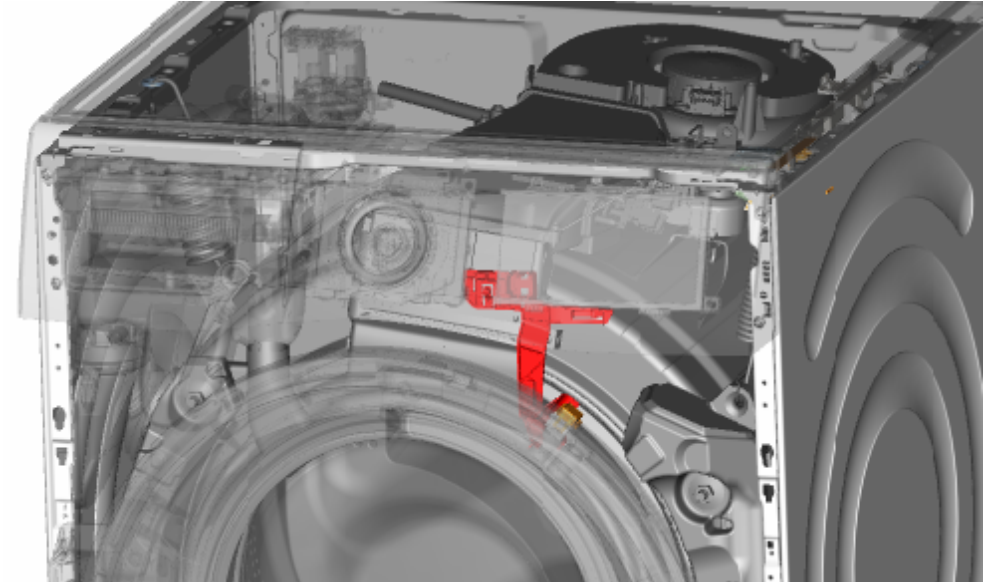

1. Pull drum light holder out of appliance.
2. Disconnect electrical connections.
3. Remove drum light from drum light holder.

### 4.10.2 Installing drum light

	<p>Observe cable installation. Cable could be trapped.</p>
---	--

- ▶ Install in reverse order.

## 4.11 Replacing front panel



### Warning

#### Slipping of tilted appliances!

Bone fractures / crush injuries

- ▶ Secure appliances against slipping.



### Caution

#### Sharp housing edges!

Cut injuries

- ▶ Wear protective gloves.



### Caution

#### Risk of falling parts due to released screws!

Injury because of falling parts.

- ▶ Secure component from falling down.



### Notice

#### Risk of falling parts due to released screws!

Damage to other parts of the appliance or at customers home e.g. bottom.

- ▶ Secure component from falling down.

#### Prerequisite:

- ✓ Appliance is disconnected from power supply.
- ✓ Appliance is disconnected from water supply.
- ✓ Appliances is freely accessible.
- ✓ [Worktop has been removed.→ Page 103](#)
- ✓ [Detergent drawer has been removed.→ Page 104](#)
- ✓ [Fascia panel has been removed.→ Page 106](#)
- ✓ [Door has been removed.→ Page 108](#)
- ✓ [Pump cover has been removed.→ Page 110](#)
- ✓ Tension ring has been removed.
- ✓ Door seal has been released at front.
- ✓ [Drum light has been removed \(optional\).→ Page 114](#)

### 4.11.1 Removing front panel

1. Lift up appliance at front.
2. Remove screws at bottom (1).

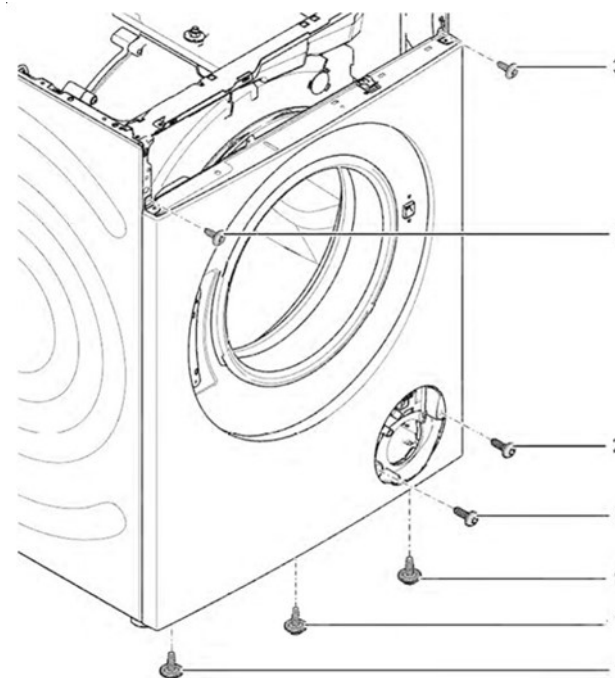

3. Lower appliance down.

4. Remove screws at front beginning from bottom to top (2, 3).

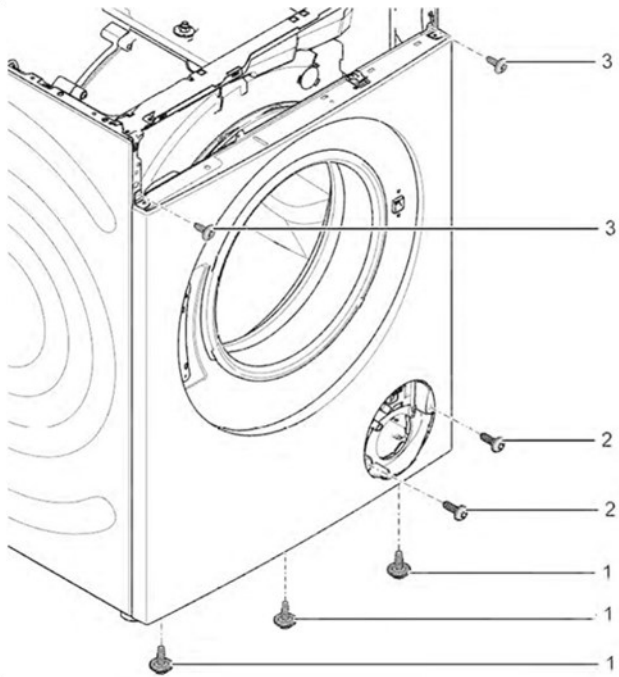

5. Remove front panel.

### 4.11.2 Installing front panel

- ▶ Install in reverse order.

# Remonditeave - Pesumasin

 <b>Selle dokumendiga seoses .....</b>	<b>118</b>
1.1 Tähtis teave .....	118
1.1.1 Eesmärk.....	118
1.2 Sümbolite selgitus .....	118
1.2.1 Ohutasemed.....	118
1.2.2 Ohusümbolid .....	118
1.2.3 Hoiatuste struktuur .....	119
1.2.4 Üldised sümbolid.....	119
 <b>Ohutus.....</b>	<b>120</b>
2.1 Üldised ohutusjuhised.....	120
2.1.1 Kõik kodumasinad.....	120
 <b>Tööriistad ja abinõud.....</b>	<b>121</b>
 <b>Remont.....</b>	<b>122</b>
4.1 Tööpinna vahetamine .....	122
4.1.1 Tööpinna eemaldamine .....	122
4.1.2 Tööpinna paigaldamine .....	122
4.2 Pesuaine sahtli vahetamine.....	123
4.2.1 Pesuaine sahtli eemaldamine .....	123
4.2.2 Pesuaine sahtli paigaldamine .....	123
4.3 Pesuaine sahtli käepideme vahetamine .....	124
4.3.1 Pesuaine sahtli käepideme eemaldamine .....	124
4.3.2 Pesuaine sahtli käepideme paigaldamine .....	124
4.4 Välispaneeli vahetamine .....	125
4.4.1 Välispaneeli eemaldamine .....	125
4.4.2 Välispaneeli paigaldamine .....	126
4.5 Ukse vahetamine.....	127
4.5.1 Ukse eemaldamine .....	127
4.5.2 Ukse paigaldamine.....	127
4.6 Ukseosade vahetamine.....	128
4.6.1 Ukse osade eemaldamine .....	128
4.6.2 Ukse osade paigaldamine .....	128
4.7 Pumba katte vahetamine .....	129
4.7.1 Pumba katte eemaldamine .....	129
4.7.2 Pumba katte paigaldamine .....	129

4.8 Ukse tihendi vahetamine .....	130
4.8.1 Ukse tihendi eemaldamine .....	130
4.8.2 Uksetihendi paigaldamine .....	130
4.9 Ukseluku vahetamine .....	131
4.9.1 Ukseluku eemaldamine.....	131
4.9.2 Ukseluku paigaldamine .....	132
4.10 Trumli valgustuse vahetamine.....	133
4.10.1 Trumli valgustuse eemaldamine .....	133
4.10.2 Trumli valgustuse paigaldamine .....	133
4.11 Esipaneeli vahetamine .....	134
4.11.1 Esipaneeli eemaldamine .....	134
4.11.2 Esipaneeli paigaldamine .....	135

# **i** Selle dokumendiga seoses

## 1.1 Tähtis teave

### 1.1.1 Eesmärk

Need remondinõuanded toetavad tarbijat seadmete iseseisval remontimisel vastavalt kehtivale ökodisaini määrusele (03/2021).





Need sisaldavad teavet selle kohta, kuidas vahetada teatud varuosi, samuti hoiatusi ning ohtusid.

Küsimuste korral võtke ühendust meie klienditeenindusega. Meie vastutame kahjustuste eest ainult siis, kui remondinõuandeid on õigesti järgitud.

## 1.2 Sümbolite selgitus

### 1.2.1 Ohutasemed

Ohutasemed koosnevad sümbolist ja märksõnast. Märksõna viitab ohu raskusastmele.

Hoiatustase	Tähendus
 <b>OHT</b>	Hoiatusteadete eiramine põhjustab surma või raskeid kehavigastusi.
 <b>HOIATUS</b>	Hoiatusteadete eiramine võib põhjustada surma või raskeid kehavigastusi.
 <b>ETTEVAATUST!</b>	Hoiatusteadete eiramine võib põhjustada kergeid kehavigastusi.
 <b>TÄHELEPANU!</b>	Hoiatusteadete eiramine võib põhjustada varakahju.

Tabel 1: Ohutasemed

### 1.2.2 Ohusümbolid

Ohusümbolid on sümboolsed kujutised, mis viitavad ohu laadile.

Selles dokumendis kasutatakse alljärgnevaid ohusümboleid.

Ohusümbol	Tähendus
	Üldine ohuteade
	Elektripingest tingitud oht
	Plahvatusoht
	Lõikeoht
	Muljumisoht

## **i** Selle dokumendiga seoses

Ohusümbol	Tähendus
	Kuumadest pindadest tingitud oht
	Tugevast magnetväljast tingitud oht
	Mitteioniseerivast kiirgusest tingitud oht

Tabel 2: Ohusümbolid

### 1.2.3 Hoiatuste struktuur

Selles dokumendis olevatel hoiatustel on standardiseeritud väljanägemine ja standardiseeritud struktuur.



	<div style="background-color: red; color: white; padding: 2px; text-align: center;"><b>⚠ OHT</b></div> <p><b>Ohu tüüp ja allikas!</b>          Ohu/hoiatuse eiramise võimalikud tagajärjed.</p> <ul style="list-style-type: none"> <li>▶ Meetmed ja ettevaatusabinõud ohu vältimiseks.</li> </ul>
--	---





Alljärgnevas näiteks on näidatud hoiatust, millega hoiatatakse liikuvatest osadest tingitud elektrilöögiu eest. Nimetatud on meetet ohu vältimiseks.

	<div style="background-color: red; color: white; padding: 2px; text-align: center;"><b>⚠ OHT</b></div> <p><b>Liikuvatest osadest tingitud elektrilöögi oht!</b>          Elektrilöögist tingitud surm</p> <ul style="list-style-type: none"> <li>▶ Enne remonditöödega alustamist ühendage seadmed elektrivõrgust lahti vähemalt 60 sekundit varem.</li> </ul>
---	--

### 1.2.4 Üldised sümbolid

Selles dokumendis kasutatakse alljärgnevaid üldisi sümboleid.

Üld. sümbol	Tähendus
	Erinõuande tunnus (tekst ja/või graafik)
	Lihtsa nõuande tunnus (ainult tekst)
	Videojuhendi lingi tunnus

Üld. sümbol	Tähendus
	Vajalike tööriistade tunnus
	Vajalike eeltingimuste tunnus
	Seisukorra tunnus (kui..., siis...)
	Tulemuse tunnus
[Start]	Klahvi või nupu tunnus
[00123456]	Materjalinumbr tunnus
Olek	Kuvatava teksti/akna tunnus (seadme ekraanil)

Tabel 3: Üldised sümbolid

## 2.1 Üldised ohutusjuhised

### 2.1.1 Kõik kodumasinad

#### **Liikuvatest osadest tingitud elektrilöögi oht!**

- Elektriliste osade remondil tehtud vead võivad põhjustada elektrilööki!
- Lahutage seade vooluvõrgust vähemalt 60 sekundit enne tööle hakkamist.
- Pärast remonti peab olema tehtud ohutuskatse vastavalt standardile VDE 0701 või riiklikele määrustele.

#### **Teravatest servadest tingitud vigastusoht!**

- Kandke kaitsekindaid.

#### **Rasketest ja liikuvatest osadest tingitud muljumisoht remondi-, puhastustööde, tõrkeotsingu ja hoolduse käigus**

- Kandke turvakingi.
- Kinnitage rasked osad allakukkumise vastu.
- Ärge toppige kehaosi liikuvate osade vahele.







#### **Oht seadme ohutusele/talitlusele!**





- Kasutage ainult originaalvaruosasid.

#### **Elektrostaatiliselt tundlike osade (ESD) kahjustamise oht!**

- Ärge puudutage moduleid, kaasa arvatud ühendusi ega transportöörlinte.

## Tööriistad ja abinõud

Määramine	Üksikasjad	Kujutised
Abitööriist [15000155]	Tööriist plastosade lahtitegemiseks	
Tähtotsikuga T20 kruvikeeraja koos puurimisaguga [00340764]	100 mm, splindiga poltidele	
Pöördemomendi mutrivõti [15000441]	Pöördemomendi mutrivõti 20-100 Nm	
Lapik kruvikeeraja [00340854]	Tera 3,5 mm x 0,6 mm x 100 mm, kaitseisolatsioon 1000 V AC	
Lapik kruvikeeraja [00340855]	Tera 5,5 mm x 1,0 mm x 125 mm, kaitseisolatsioon 1000 V AC	
Peeneotsalised tangid, nurga all [00341269]	Pikkus 200 mm	
Külg-lõiketangid [00342182]	Pikkus: 200 mm	



Määramine	Üksikasjad	Kujutised
Kombineeritud mutrivõti [00340811]	Mutrivõtme suurus 10°mm, M6	
Combination wrench [00340814]	Mutrivõtme suurus 13°mm, M8	
Kombineeritud mutrivõti [00340817]	Mutrivõtme suurus 17 mm, M10	
Kombineeritud mutrivõti [15000459]	Mutrivõtme suurus 16°mm, M10	

## 4.1 Tööpinna vahetamine

### Eritööriistad:

-  Auguga tähtotsik TX20      Pikkus 152 mm, kasutatav pikkus [00341272]  
124 mm, 1/4" kuuskantvõti  
(6,35 mm), splindiga poltidele

### Nõue:

-  Seade on toitest lahutatud.
-  Seade on veeühendusest lahutatud.

### 4.1.1 Tööpinna eemaldamine

- ▶ 1. Eemaldage kruvid (1).
- 2. Suruge tööpinda seadme tagasuunas (2).
- 3. Liigutage tööpinda eemaldamiseks ülessuunas (3).

### 4.1.2 Tööpinna paigaldamine



Järgige kaabli paigaldust. Kaabel võib kinni jääda.

- ▶ Paigaldage vastupidises järjekorras.

## 4.2 Pesuaine sahtli vahetamine

### Nõue:

- ✓ Seade on toitest lahutatud.
- ✓ Seade on veeühendusest lahutatud.

### 4.2.1 Pesuaine sahtli eemaldamine

1. Tõmmake pesuaine sahtel välja.
2. 1. Suru kasseti (1) alla.  
2. Eemaldage pesuaine sahtel (2).

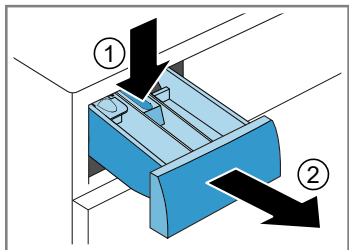

### 4.2.2 Pesuaine sahtli paigaldamine

- ▶ Paigaldage vastupidises järjekorras.

## 4.3 Pesuaine sahtli käepideme vahetamine

### Nõue:

- ✓ Seade on toitest lahutatud.
- ✓ Seade on veeühendusest lahutatud.
- ✓ [Pesuaine sahtel eemaldatud.](#)→123

### 4.3.1 Pesuaine sahtli käepideme eemaldamine

1. Vabastage kinnituselemendid.

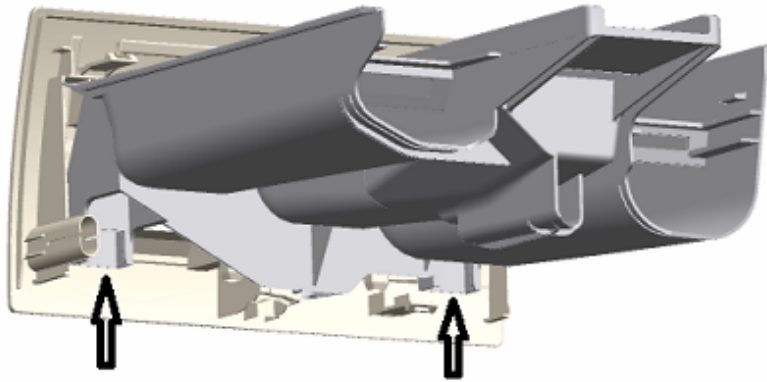





2. Eemaldage pesuaine sahtli käepide.

### 4.3.2 Pesuaine sahtli käepideme paigaldamine

- ▶ Paigaldage vastupidises järjekorras.

## 4.4 Välispaneeli vahetamine

Tootjana oleme kohustatud tagama tarbijatele välispaneeli varuosad, sealhulgas remontimisjuhendi, vastavalt direktiivile (EL) 2019/2023. Siiski soovime viidata sellele, et pärast välispaneeli vahetamist on enne seadme kasutuselevõttu vajalik lasta kvalifitseeritud elektrikul teha elektrotehniline ohutuskatse. See isik peab olema riiklike seaduste, määruste ja standardite järgi tõendatult koolitatud.

	<b>⚠ OHT</b>
	<p><b>Liikuvatest osadest tingitud elektrilöögi oht!</b> Kui remonditööd on valesti tehtud, esineb elektrilöögist tingitud eluohu.</p> <ul style="list-style-type: none"> <li>▶ Elektrilisi osasid peavad parandama kvalifitseeritud elektrikud.</li> <li>▶ Pärast remonti peab olema tehtud ohutuskatse vastavalt standardile VDE 0701 või riiklikele määrustele.</li> </ul>
	<b>⚠ HOIATUS</b>
	<p><b>Viltuses asendis seadmete libisemisoht!</b> Luumurrud/muljumised</p> <ul style="list-style-type: none"> <li>▶ Kindlustage seadmed libisemise vastu.</li> </ul>
	<b>⚠ ETTEVAATUST!</b>
	<p><b>Teravad korpuse osad!</b> Lõikehaavad</p> <ul style="list-style-type: none"> <li>▶ Kandke kaitsekindaid.</li> </ul>
	<b>⚠ ETTEVAATUST!</b>
	<p><b>Lahtikeeratud poltidest tingitud osade kukkumisoht!</b> Kukkuvatest osadest tingitud vigastused.</p> <ul style="list-style-type: none"> <li>▶ Kinnitage osa allakukkumise vastu.</li> </ul>
	<b>TÄHELEPANU!</b>
	<p><b>Lahtikeeratud poltidest tingitud osade kukkumisoht!</b> Seadme teiste osade kahjustused või klientide vara kahjustused.</p> <ul style="list-style-type: none"> <li>▶ Kinnitage osa allakukkumise vastu.</li> </ul>

### Nõue:

- ✔ Seade on toitest lahutatud.
- ✔ Seade on veeühendusest lahutatud.
- ✔ [Tööpind on eemaldatud.→ 122](#)

### ✔ [Pesuaine sahtel eemaldatud.→123](#)

#### 4.4.1 Välispaneeli eemaldamine

1. 1. Eemaldage kruvid (1).
2. 2. Vabastage kinnituselemendid (2, 3).

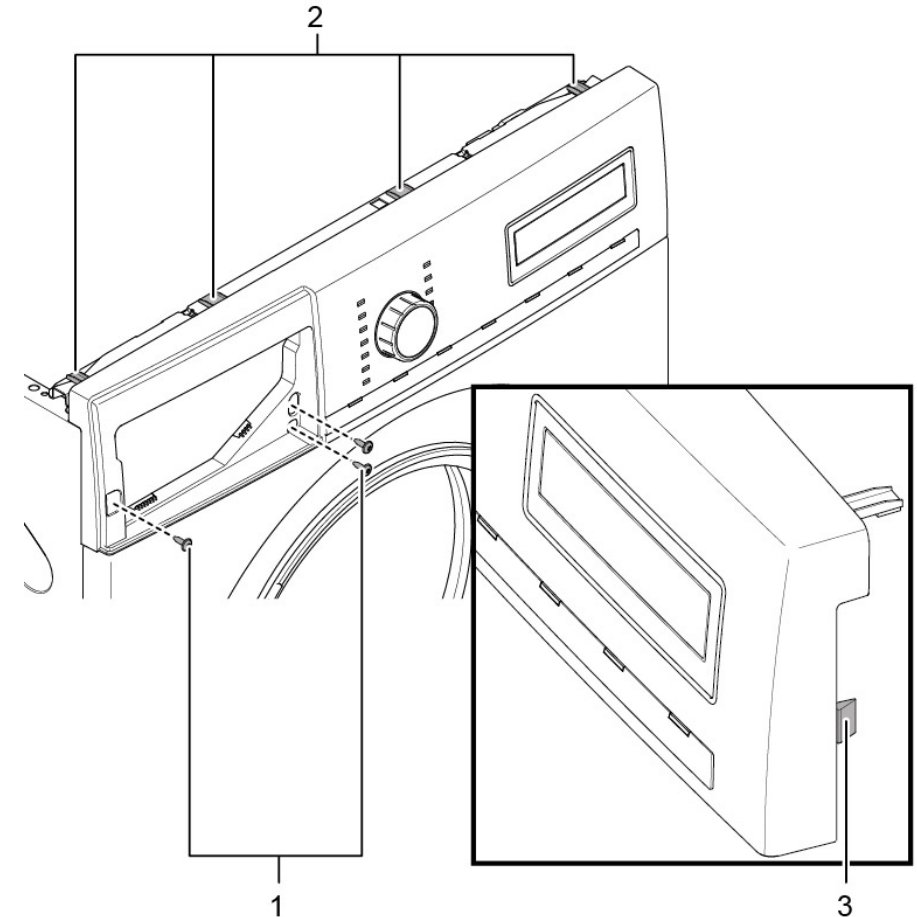

2. Lahutage juhtseadise pistik.
3. Eemaldage välispaneel.

## 4.4.2 Välispaneeli paigaldamine



Järgige kaabli paigaldust. Kaabel võib kinni jääda.

- ▶ Paigaldage vastupidises järjekorras.

## 4.5 Ukse vahetamine



### ⚠ ETTEVAATUST!

#### Avatud liigendi piirkond!

Sõrmede muljumine/kinnijäämine

- ▶ Ärge pistke käsi liigendi piirkonda.
- ▶ Kandke kaitsekindaid.



### ⚠ ETTEVAATUST!

#### Lahtikeeratud poldidest tingitud osade kukumisoht!

Kukkuvatest osadest tingitud vigastused.

- ▶ Kinnitage osa allakukkumise vastu.



### TÄHELEPANU!

#### Lahtikeeratud poldidest tingitud osade kukumisoht!

Seadme teiste osade kahjustused või klientide vara kahjustused.

- ▶ Kinnitage osa allakukkumise vastu.

#### Nõue:

- ✔ Seade on toitest lahutatud.
- ✔ Seade on veeühendusest lahutatud.
- ✔ Uks on avatud.

### 4.5.1 Ukse eemaldamine

1. Eemaldage poldid (1).

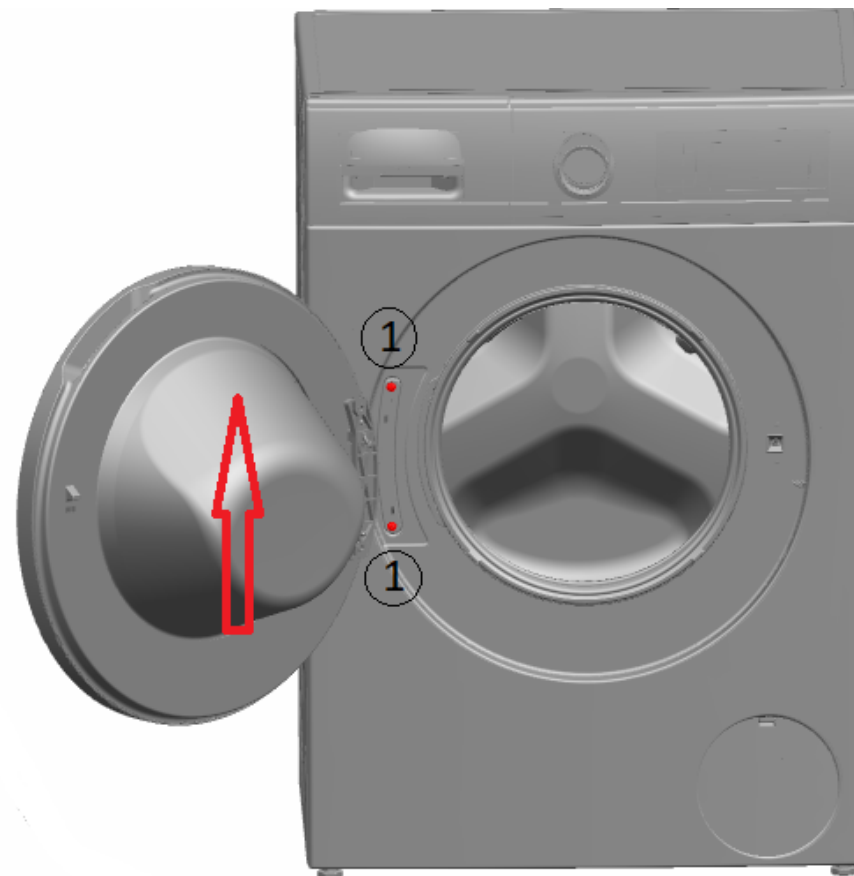



2. Eemaldage uks ülessuunas.

### 4.5.2 Ukse paigaldamine

- ▶ Paigaldage vastupidises järjekorras.

## 4.6 Ukseosade vahetamine

	<b>⚠ HOIATUS</b>
	<b>Rasked ja liikuvad komponendid!</b> Muljumisoht remondi-, puhastustööde, tõrkeotsingu ja hoolduse käigus <ul style="list-style-type: none"><li>▶ Kandke turvakingi.</li><li>▶ Kinnitage rasked komponendid allakukkumise vastu.</li><li>▶ Ärge pange kehaosi liikuvate komponentide vahele.</li></ul>

	<b>⚠ ETTEVAATUST!</b>
	<b>Avatud liigendi piirkond!</b> Sõrmede muljumine/kinnijäämine <ul style="list-style-type: none"><li>▶ Ärge pistke käsi liigendi piirkonda.</li><li>▶ Kandke kaitsekindaid.</li></ul>

### Nõue:

- ✔ Seade on toitest lahutatud.
- ✔ Seade on veeühendusest lahutatud.
- ✔ [Uks on eemaldatud. → 127](#)

### 4.6.1 Ukse osade eemaldamine

- ▶ Võtke uks lahti seestpoolt väljapoole.

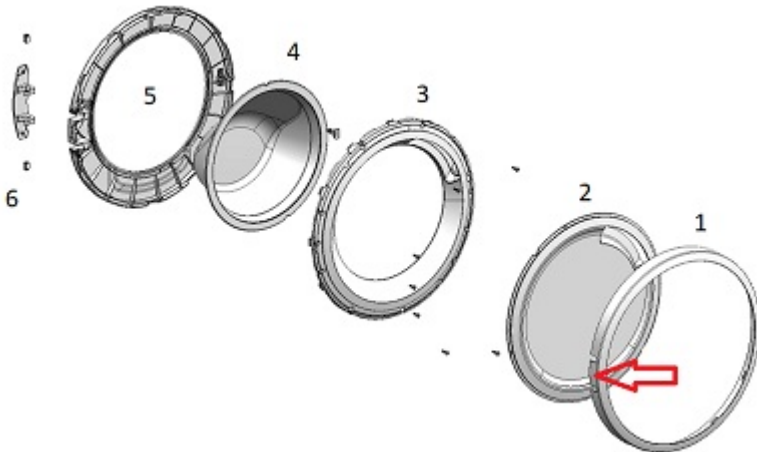

### 4.6.2 Ukse osade paigaldamine

- ▶ Paigaldage vastupidises järjekorras.

## 4.7 Pumba kate vahetamine

### Nõue:

- ✓ Seade on toitest lahutatud.
- ✓ Seade on veeühendusest lahutatud.

### 4.7.1 Pumba kate eemaldamine

1. Avage pumba kate.

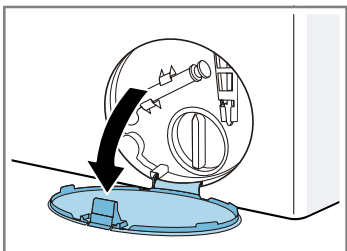

2. Eemaldage pumba kate.

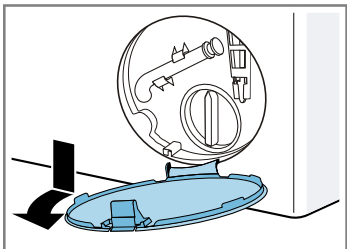



### 4.7.2 Pumba kate paigaldamine

- ▶ Paigaldage vastupidises järjekorras.

## 4.8 Ukse tihendi vahetamine

	<b>⚠ ETTEVAATUST!</b> <b>Teravad korpuse osad!</b> Lõikehaavad ▶ Kandke kaitsekindaid.
--	---

	<b>⚠ ETTEVAATUST!</b> <b>Lahtikeeratud poltidest tingitud osade kukumisoht!</b> Kukkuvatest osadest tingitud vigastused. ▶ Kinnitage osa allakukkumise vastu.
--	--

	<b>TÄHELEPANU!</b> <b>Lahtikeeratud poltidest tingitud osade kukumisoht!</b> Seadme teiste osade kahjustused või klientide vara kahjustused. ▶ Kinnitage osa allakukkumise vastu.
--	--

### Nõue:

- ✔ Seade on toitest lahutatud.
- ✔ Seade on veeühendusest lahutatud.
- ✔ Seadmetele pääseb vabalt ligi.
- ✔ [Tööpind on eemaldatud.→122](#)
- ✔ [Pesuaine sahtel eemaldatud.→123](#)
- ✔ [Välispaneel on eemaldatud.→125](#)
- ✔ [Uks on eemaldatud.→127](#)
- ✔ [Pumba kaas on eemaldatud.→129](#)
- ✔ [Esipaneel on eemaldatud.→134](#)
- ✔ [Drum Light on eemaldatud \(valikuline\).→133](#)

### 4.8.1 Ukse tihendi eemaldamine

1. Vabastage kõik voolikuühendused.

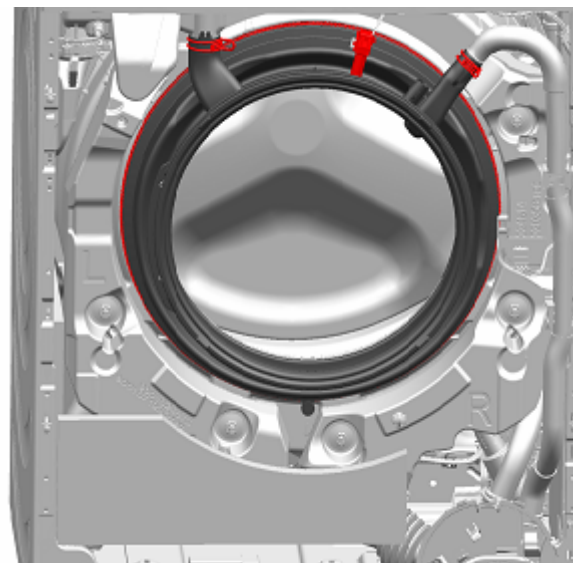

2. Eemaldage uksetihend.





### 4.8.2 Uksetihendi paigaldamine

	<b>⚠ HOIATUS</b> <b>Valest paigaldusest tingitud osade kukumisoht!</b> Vigastused või seadme kahjustused. ▶ Pingutage pagasitihendi pingutusrõngast jõuga 3,4 Nm.
--	--

- ▶ Paigaldage vastupidises järjekorras.

## 4.9 Ukseluku vahetamine

Tootjana oleme kohustatud tagama tarbijatele ukseluku varuosad, sealhulgas remontimisjuhendi, vastavalt direktiivile (EL) 2019/2023. Siiski soovime viidata sellele, et pärast ukseluku vahetamist on enne seadme kasutuselevõttu vajalik lasta kvalifitseeritud elektrikul teha elektrotehniline ohutuskatse. See isik peab olema riiklike seaduste, määruste ja standardite järgi tõendatult koolitatud.

	<p style="text-align: center;"><b>⚠ OHT</b></p> <p><b>Liikuvatest osadest tingitud elektrilöögi oht!</b> Kui remonditööd on valesti tehtud, esineb elektrilöögist tingitud eluohu.</p> <ul style="list-style-type: none"> <li>▶ Elektrilisi osasid peavad parandama kvalifitseeritud elektrikud.</li> <li>▶ Pärast remonti peab olema tehtud ohutuskatse vastavalt standardile VDE 0701 või riiklikele määrustele.</li> </ul>
	<p style="text-align: center;"><b>⚠ HOIATUS</b></p> <p><b>Viltuses asendis seadmete libisemisoht!</b> Luumurrud/muljumised</p> <ul style="list-style-type: none"> <li>▶ Kindlustage seadmed libisemise vastu.</li> </ul>
	<p style="text-align: center;"><b>⚠ ETTEVAATUST!</b></p> <p><b>Teravad korpuse osad!</b> Lõikehaavad</p> <ul style="list-style-type: none"> <li>▶ Kandke kaitsekindaid.</li> </ul>
	<p style="text-align: center;"><b>⚠ ETTEVAATUST!</b></p> <p><b>Lahtikeeratud poltidest tingitud osade kukkumisoht!</b> Kukkuvatest osadest tingitud vigastused.</p> <ul style="list-style-type: none"> <li>▶ Kinnitage osa allakukkumise vastu.</li> </ul>
	<p style="text-align: center;"><b>TÄHELEPANU!</b></p> <p><b>Lahtikeeratud poltidest tingitud osade kukkumisoht!</b> Seadme teiste osade kahjustused või klientide vara kahjustused.</p> <ul style="list-style-type: none"> <li>▶ Kinnitage osa allakukkumise vastu.</li> </ul>

### Nõue:

- ✓ Seade on toitest lahutatud.
- ✓ Seade on veeühendusest lahutatud.
- ✓ Seadmetele pääseb vabalt ligi.

- ✓ [Tööpind on eemaldatud.→122](#)
- ✓ [Pesuaine sahtel eemaldatud.→123](#)
- ✓ [Välispaneel on eemaldatud.→125](#)
- ✓ [Uks on eemaldatud.→127](#)
- ✓ Pingutusrõngas on eemaldatud.
- ✓ [Uksetihend on eemaldatud.→130](#)
- ✓ [Pumba kaas on eemaldatud.→129](#)
- ✓ [Esipaneel on eemaldatud.→134](#)

### 4.9.1 Ukseluku eemaldamine

1. Ühendage ukseluku pistik lahti.
2. Vabastage ukselukk.



3. Eemaldage ukselukk.

## 4.9.2 Ukseluku paigaldamine

Ukselukk peab olema õiges asendis, et tagada seadme avariiuksse avanemise funktsioon.

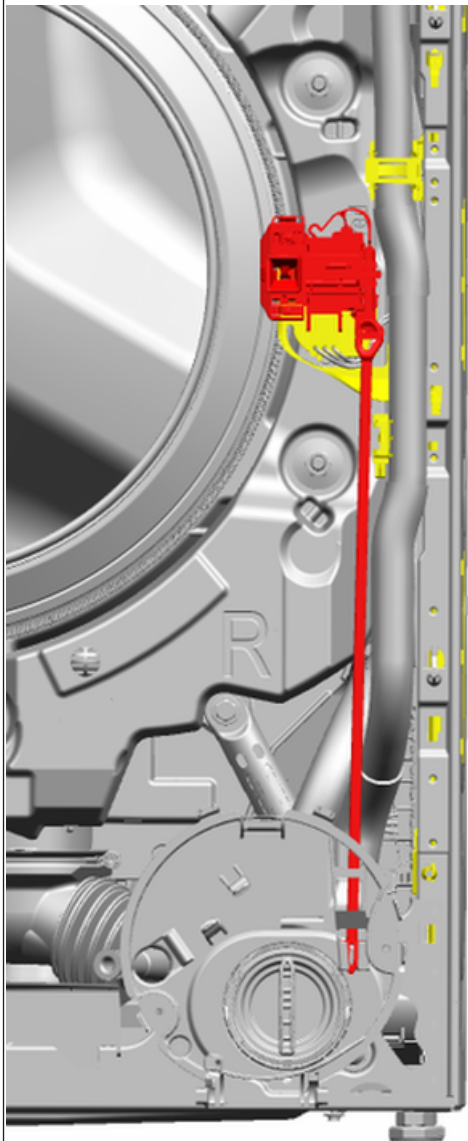

- ▶ Paigaldage vastupidises järjekorras.

## 4.10 Trumli valgustuse vahetamine



### HOIATUS

**Viltuses asendis seadmete libisemisoht!**  
Luumurrud/muljumised  
▶ Kindlustage seadmed libisemise vastu.



### ETTEVAATUST!

**Teravad korpuse osad!**  
Lõikehaavad  
▶ Kandke kaitsekindaid.



### ETTEVAATUST!

**Lahtikeeratud poltidest tingitud osade kukkumisoht!**  
Kukkuvatest osadest tingitud vigastused.  
▶ Kinnitage osa allakukkumise vastu.



### TÄHELEPANU!

**Lahtikeeratud poltidest tingitud osade kukkumisoht!**  
Seadme teiste osade kahjustused või klientide vara kahjustused.  
▶ Kinnitage osa allakukkumise vastu.

#### Nõue:

- ✓ Seade on toitest lahutatud.
- ✓ Seade on veeühendusest lahutatud.
- ✓ Seadmetele pääseb vabalt ligi.
- ✓ [Tööpind on eemaldatud.→122](#)
- ✓ [Pesuaine sahtel eemaldatud.→123](#)
- ✓ [Välispaneel on eemaldatud.→125](#)

## 4.10.1 Trumli valgustuse eemaldamine

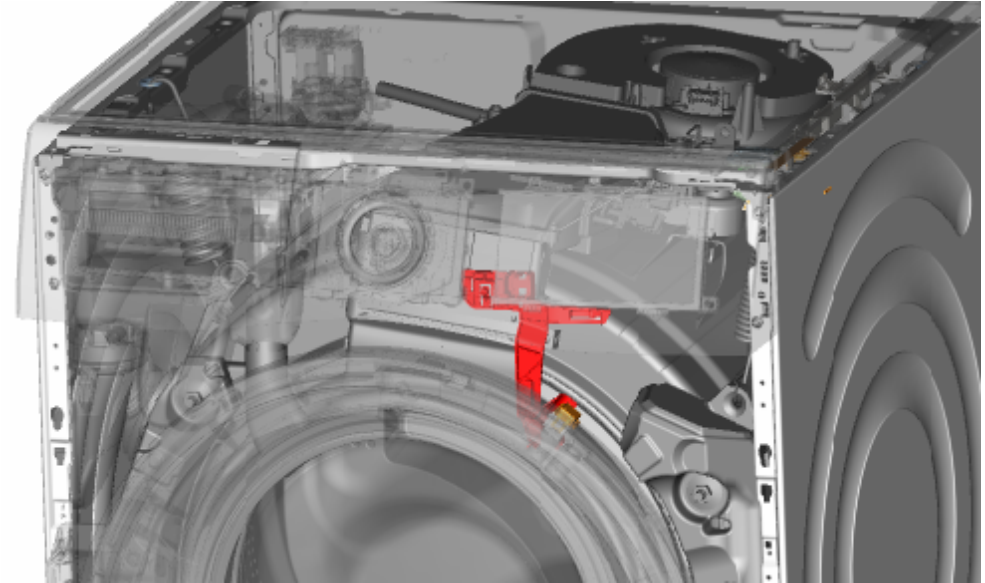

1. Tõmmake trumli valgustuse hoidik seadmest välja.
2. Ühendage elektriühendused lahti.
3. Eemaldage trumli valgustus trumli valgustuse hoidikust.

## 4.10.2 Trumli valgustuse paigaldamine



Järgige kaabli paigaldust. Kaabel võib kinni jääda.

- ▶ Paigaldage vastupidises järjekorras.

## 4.11 Esipaneeli vahetamine



### HOIATUS

**Viltuses asendis seadmete libisemisoht!**

Luumurrud/muljumised

- ▶ Kindlustage seadmed libisemise vastu.



### ETTEVAATUST!

**Teravad korpuse osad!**

Lõikehaavad

- ▶ Kandke kaitsekindaid.



### ETTEVAATUST!

**Lahtikeeratud poltidest tingitud osade kukkumisoht!**

Kukkuvatest osadest tingitud vigastused.

- ▶ Kinnitage osa allakukkumise vastu.



### TÄHELEPANU!

**Lahtikeeratud poltidest tingitud osade kukkumisoht!**

Seadme teiste osade kahjustused või klientide vara kahjustused.

- ▶ Kinnitage osa allakukkumise vastu.

### Nõue:

- ✓ Seade on toitest lahutatud.
- ✓ Seade on veeühendusest lahutatud.
- ✓ Seadmetele pääseb vabalt ligi.
- ✓ [Tööpind on eemaldatud.→122](#)
- ✓ [Pesuaine sahtel eemaldatud.→123](#)
- ✓ [Välispaneel on eemaldatud.→125](#)
- ✓ [Uks on eemaldatud.→127](#)
- ✓ [Pumba kaas on eemaldatud.→129](#)
- ✓ Pingutusrõngas on eemaldatud.
- ✓ Uksetihend on esiosas vabastatud.
- ✓ [Drum Light on eemaldatud \(valikuline\).→133](#)

### 4.11.1 Esipaneeli eemaldamine

1. Kergitage seadet eestpoolt.

2. Eemaldage põhjal olevad poldid (1).

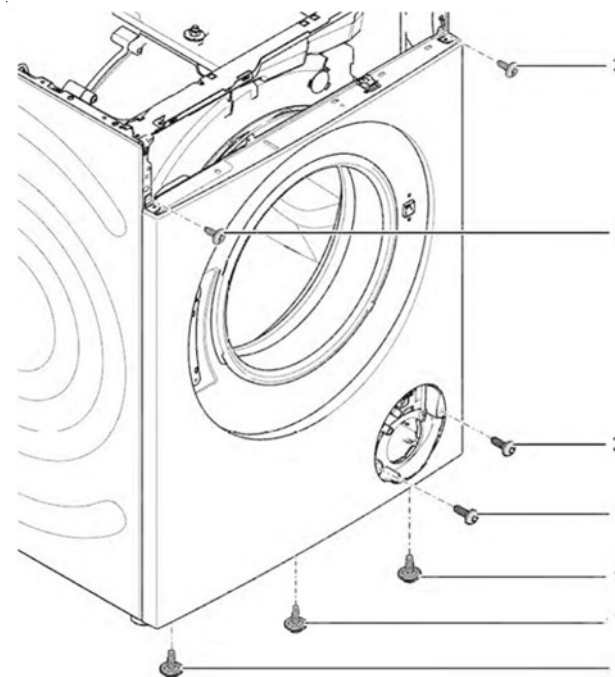

3. Langetage seadet allapoole.

4. Eemaldage esiosal olevad poldid suunaga alt üles (2, 3).

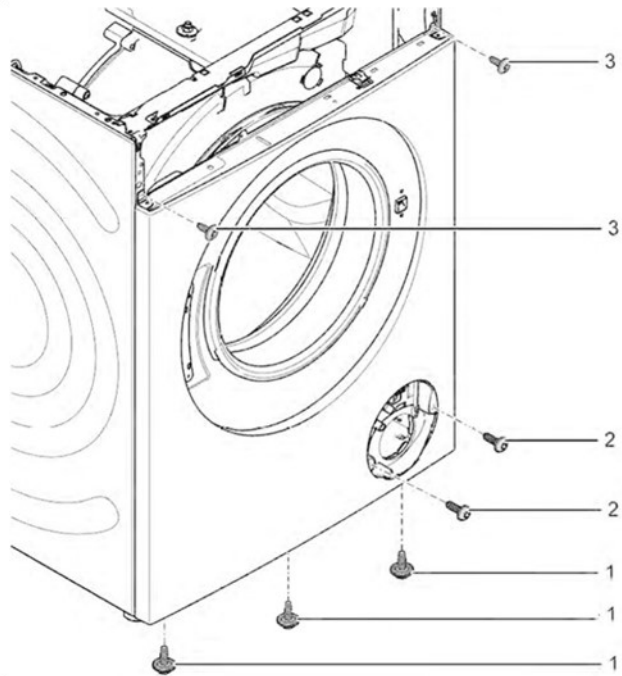





5. Eemaldage esipaneel.

## 4.11.2 Esipaneeli paigaldamine

- ▶ Paigaldage vastupidises järjekorras.

# Korjausvinkit - Pyykinpesukone

 <b>Tämä asiakirja</b> .....	<b>137</b>
1.1 Tärkeitä tietoja.....	137
1.1.1 Tarkoitus .....	137
1.2 Symboleiden merkitys.....	137
1.2.1 Vaaratasot.....	137
1.2.2 Varoitusmerkit.....	137
1.2.3 Varoitusten rakenne .....	138
1.2.4 Yleiset symbolit.....	138
 <b>Turvallisuus</b> .....	<b>139</b>
2.1 Yleiset turvallisuusohjeet.....	139
2.1.1 Kaikki kotitalouskoneet.....	139
 <b>Työkalut ja apuvälineet</b> .....	<b>140</b>
 <b>Korjaus</b> .....	<b>141</b>
4.1 Työtason vaihtaminen.....	141
4.1.1 Työtason poistaminen .....	141
4.1.2 Työtason asennus.....	141
4.2 Pesuainelokeron vaihtaminen.....	142
4.2.1 Pesuainelokeron poistaminen .....	142
4.2.2 Pesuainelokeron asentaminen .....	142
4.3 Pesuainelokeron kahvan vaihtaminen .....	143
4.3.1 Pesuainelokeron kahvan poistaminen .....	143
4.3.2 Pesuainelokeron kahvan asentaminen .....	143
4.4 Ohjauspaneelin vaihtaminen .....	144
4.4.1 Ohjauspaneelin poistaminen.....	144
4.4.2 Ohjauspaneelin asentaminen.....	145
4.5 Luukun vaihtaminen.....	146
4.5.1 Luukun poistaminen .....	146
4.5.2 Luukun asennus .....	146
4.6 Luukun komponenttien vaihtaminen.....	147
4.6.1 Luukun komponenttien poistaminen .....	147
4.6.2 Luukun komponenttien asennus.....	147
4.7 Pumpun suojuksen vaihtaminen .....	148
4.7.1 Pumpun suojuksen poistaminen.....	148
4.7.2 Pumpun suojuksen asennus .....	148

4.8 Luukun tiivisteen vaihtaminen .....	149
4.8.1 Luukun tiivisteen poistaminen.....	149
4.8.2 Luukun tiivisteen asennus .....	149
4.9 Luukun lukitsimen vaihtaminen .....	150
4.9.1 Luukun lukitsimen poistaminen.....	150
4.9.2 Luukun lukitsimen asennus .....	151
4.10 Rummun lampun vaihtaminen.....	152
4.10.1 Rummun lampun poistaminen .....	152
4.10.2 Rummun lampun asennus .....	152
4.11 Etupaneelin vaihtaminen .....	153
4.11.1 Etupaneelin poistaminen.....	153
4.11.2 Etupaneelin asentaminen.....	154

# Tämä asiakirja

## 1.1 Tärkeitä tietoja

### 1.1.1 Tarkoitus

Näiden korjausohjeiden tarkoituksena on auttaa kuluttajaa korjaamaan laitteita itse ekologista suunnittelua koskevan asetuksen (päivitys 03/2021) mukaisesti.



Ne sisältävät tietoja siitä, miten määrätyt varaosat voidaan vaihtaa. Lisäksi niihin sisältyy tietoja varoituksista ja riskeistä.

Ota yhteyttä huoltopalveluun, jos sinulla on kysyttävää. Vastamme vahingoista vain, jos korjausohjeita on noudatettu oikein.

## 1.2 Symboleiden merkitys

### 1.2.1 Vaaratasot

Varoitustasot koostuvat symbolista ja huomiosanasta. Huomiosanat ilmoittava vaaran vakavuuden.

Varoitustaso	Merkitys
 <b>VAARA</b>	Varoituksen laiminlyönti johtaa kuolemaan tai vakaviin loukkaantumisiin.
 <b>VAROITUS</b>	Varoituksen laiminlyönti voi johtaa kuolemaan tai vakaviin loukkaantumisiin.
 <b>HUOMAA</b>	Varoituksen laiminlyönti voi johtaa lieviin loukkaantumisiin.
<b>HUOMIO!</b>	Varoituksen laiminlyönti voi johtaa omaisuusvahinkoihin.

Taulukko 1: Vaaratasot

### 1.2.2 Varoitusmerkit

Varoitusmerkit ovat symboleita sisältäviä esityksiä, jotka osoittavat vaaran tyyppin.

Tässä asiakirjassa käytetään seuraavia varoitusmerkkejä:

Varoitusmerkki	Merkitys
	Yleinen varoitus
	Sähköjännitteestä aiheutuva vaara
	Räjähdysvaara
	Viiltohaavojen vaara
	Murskautumisen vaara

# Tämä asiakirja

Varoitusmerkki	Merkitys
	Kuumista pinnoista aiheutuva vaara
	Voimakkaasta magneettikentästä aiheutuva vaara
	Ionisoimattomasta säteilystä aiheutuva vaara



Taulukko 2: Varoitusmerkit

## 1.2.3 Varoitusten rakenne

Tämän asiakirjan sisältämällä varoituksilla on standardoitu ulkonäkö ja rakenne.



	<div style="background-color: red; color: white; padding: 2px; text-align: center;"> <b>VAARA</b></div> <p><b>Vaaran tyyppi ja lähde!</b> Vaaran/varoituksen laiminlyönnistä mahdollisesti aiheutuvat seuraukset.</p> <ul style="list-style-type: none"><li>▶ Vaaran ehkäisemiseen liittyvät toimenpiteet ja kiellot.</li></ul>
--	--

Seuraavassa esimerkissä näytetään varoitus, joka varoittaa jännitteisten osien aiheuttamasta sähköiskusta. Vaaran välttämiseksi suoritettava toimenpide mainitaan.

	<div style="background-color: red; color: white; padding: 2px; text-align: center;"> <b>VAARA</b></div> <p><b>Jännitteisten osien aiheuttama sähköiskun vaara!</b> Sähköiskun aiheuttama kuolema</p> <ul style="list-style-type: none"><li>▶ Erotta laitteet sähkövirrasta vähintään 60 sekuntia ennen korjaustöiden aloittamista.</li></ul>
---	---

## 1.2.4 Yleiset symbolit

Tässä asiakirjassa käytetään seuraavia yleisiä symboleja:

Yl. symboli	Merkitys
	Erikoisohjeen tunniste (teksti ja/tai kaavio)
	Yksinkertaisen ohjeen tunniste (vain teksti)

Yl. symboli	Merkitys
	Video-opetusohjelmaan johtavan linkin tunniste
	Tarvittavien työkalujen tunniste
	Tarvittavien edellytysten tunniste
	Ehdon (jos ..., sitten ...) tunniste
	Tuloksen tunniste
	Näppäimen tai painikkeen tunniste
	Materiaalinumeron tunniste
	Näytetyn tekstin/ikkunan (laitteen näytössä) tunniste

Taulukko 3: Yleiset symbolit

## 2.1 Yleiset turvallisuusohjeet

### 2.1.1 Kaikki kotitalouskoneet

#### **Jännitteisten osien aiheuttama sähköiskun vaara!**

- Virheet sähkökomponentteja sisältävissä korjauksissa voivat johtaa sähköiskuun!
- Kytke kone irti verkkovirrasta vähintään 60 sekuntia ennen töiden aloittamista.
- Pyydä korjauksen jälkeen suorittamaan VDE 0701 -säädöksen tai maakohtaisten säädösten mukainen turvallisuustesti.

#### **Terävistä reunoista aiheutuva loukkaantumisvaara!**

- Käytä suojakäsineitä.

#### **Painavista ja liikkuvista komponenteista aiheutuva murskautumisen riski korjauksen, kunnossapidon, vianetsinnän ja huollon aikana**

- Käytä suojakenkiä.
- Estä painavien komponenttien putoaminen.
- Älä koske liikkuviin komponentteihin.







#### **Laitteen turvallisuudelle/toiminnalle aiheutuva riski!**





- Käytä vain alkuperäisiä varaosia.

#### **Staattiselle sähkölle herkkien komponenttien (ESDS) vaurioitumisen riski!**

- Älä koske moduuleihin, liitännät ja johdinreitit mukaan luettuna.

## Työkalut ja apuvälineet

Nimitys	Yksityiskohdat	Kuvat
Lisätyökalu [15000155]	Työkalu, jota käytetään muoviosien irrottamiseen	
Torx T20 -ruuvimeisseli, reiällinen [00340764]	100 mm, ruuveille lukituksella	
Momenttiavain [15000441]	Momenttiavain 20 - 100 Nm	
Uraruuvimeisseli [00340854]	Terä 3,5 mm x 0,6 mm x 100 mm, suojaeristys 1000 V AC	
Uraruuvimeisseli [00340855]	Terä 5,5 mm x 1,0 mm x 125 mm, suojaeristys 1000 V AC	
Nokkapihdit, taivutetut [00341269]	Pituus 200 mm	
Sivuleikkurit [00342182]	Pituus: 200 mm	



Nimitys	Yksityiskohdat	Kuvat
Yhdistelmä kiintoavain [00340811]	Avainväli 10 <sup>o</sup> mm, M6	
Combination wrench [00340814]	Avainväli 13 <sup>o</sup> mm, M8	
Yhdistelmä kiintoavain [00340817]	Avainväli 17 mm, M10	
Yhdistelmä kiintoavain [15000459]	Avainväli 16 <sup>o</sup> mm, M10	

## 4.1 Työtason vaihtaminen

### Erikoistyökalut:

-  Torx-kärki TX20, reikä Pituus 152 mm, käytettävä pituus 124 mm, 1/4" kuusioruuvimeisseli (6,35 mm), ruuveille lukituksella [00341272]

### Vaatus:

-  Kone on erotettu teholähteestä.
-  Kone on erotettu vedenjakelusta.

### 4.1.1 Työtason poistaminen

- ▶ 1. Poista ruuvit (1).
- 2. Työnnä työtaso koneen takaosaan (2).
- 3. Nosta työtaso ylös (3) ja poista se.

### 4.1.2 Työtason asennus



Tarkasta johdon asennus. Johto voi olla jäänyt väliin.

- ▶ Asenna vastakkaisessa järjestyksessä.

## 4.2 Pesuainelokeron vaihtaminen

### Vaatus:

- ✓ Kone on erotettu tehölähteestä.
- ✓ Kone on erotettu vedenjakelusta.

### 4.2.1 Pesuainelokeron poistaminen

1. Vedä pesuainelokero ulos.
2. 1. Paina liitintä sisään (1).  
2. Poista pesuainelokero (2).

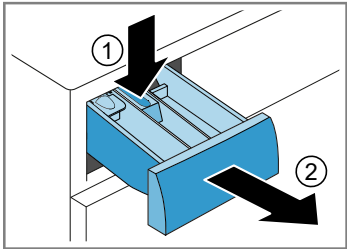

### 4.2.2 Pesuainelokeron asentaminen

- ▶ Asenna vastakkaisessa järjestyksessä.

## 4.3 Pesuainelokeron kahvan vaihtaminen

### Vaatus:

- ✓ Kone on erotettu tehollähteestä.
- ✓ Kone on erotettu vedenjakelusta.
- ✓ [Pesuainelokero on poistettu. → 142](#)

### 4.3.1 Pesuainelokeron kahvan poistaminen

1. Vapauta lukitusosat.

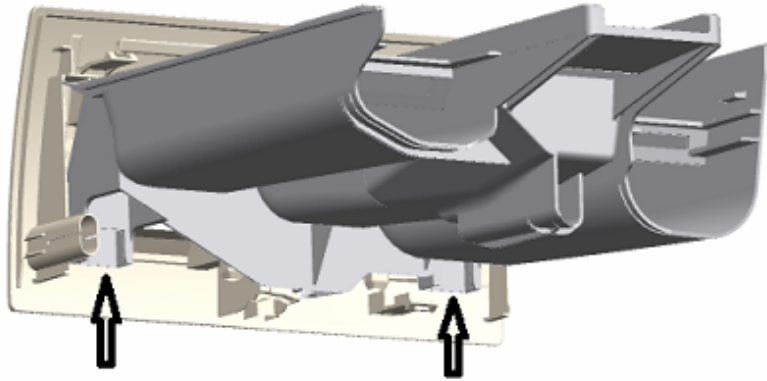

2. Poista pesuainelokeron kahva.

### 4.3.2 Pesuainelokeron kahvan asentaminen

- ▶ Asenna vastakkaisessa järjestyksessä.

## 4.4 Ohjauspaneelin vaihtaminen

Valmistajana olemme veloitettuja toimittamaan kuluttajille varaosana ohjauspaneelin sekä korjausohjeet (EU) 2019/2023 -säädöksen mukaisesti. Haluaisimme kuitenkin huomauttaa, että ohjauspaneelin vaihtamisen jälkeen pätevän sähköasentajan on testattava sähkötekniinen turvallisuus ennen kuin laite otetaan uudelleen käyttöön. Tällä henkilöllä on oltava todistettavissa oleva pätevyys maan erityisten lakien, säädösten ja standardien mukaisesti.

	<b>VAARA</b>
	<p><b>Jännitteisten osien aiheuttama sähköiskun vaara!</b> Sähköiskusta aiheutuva hengenvaara väärän korjauksen tapauksessa</p> <ul style="list-style-type: none"> <li>▶ Sähköosien korjaus tulisi antaa pätevien sähköasentajien suoritettavaksi.</li> <li>▶ Pyydä korjauksen jälkeen suorittamaan VDE 0701 -säädöksen tai maakohtaisten säädösten mukainen turvallisuustesti.</li> </ul>

	<b>VAROITUS</b>
	<p><b>Kallistetun koneen luiskahtaminen!</b> Luunmurtumat/murskavammat</p> <ul style="list-style-type: none"> <li>▶ Estä koneiden luiskahtaminen.</li> </ul>

	<b>HUOMAA</b>
	<p><b>Terävät kotelon reunat!</b> Viiltovammat</p> <ul style="list-style-type: none"> <li>▶ Käytä suojakäsineitä.</li> </ul>

	<b>HUOMAA</b>
	<p><b>Ruuvien avaamisesta aiheutuva osien putoamisen riski!</b> Loukkaantuminen putoavien osien vuoksi.</p> <ul style="list-style-type: none"> <li>▶ Estä komponentin putoaminen.</li> </ul>

	<b>HUOMIO!</b>
	<p><b>Ruuvien avaamisesta aiheutuva osien putoamisen riski!</b> Vauriot koneen muille osille tai asiakkaan kodille, esim. lattia.</p> <ul style="list-style-type: none"> <li>▶ Estä komponentin putoaminen.</li> </ul>

### Vaatus:

- ✓ Kone on erotettu tehollähteestä.
- ✓ Kone on erotettu vedenjakelusta.

✓ [Työtaso on poistettu.→141](#)

✓ [Pesuainelokero on poistettu.→142](#)

### 4.4.1 Ohjauspaneelin poistaminen

1. Poista ruuvit (1).
2. Vapauta lukitusosat (2, 3).

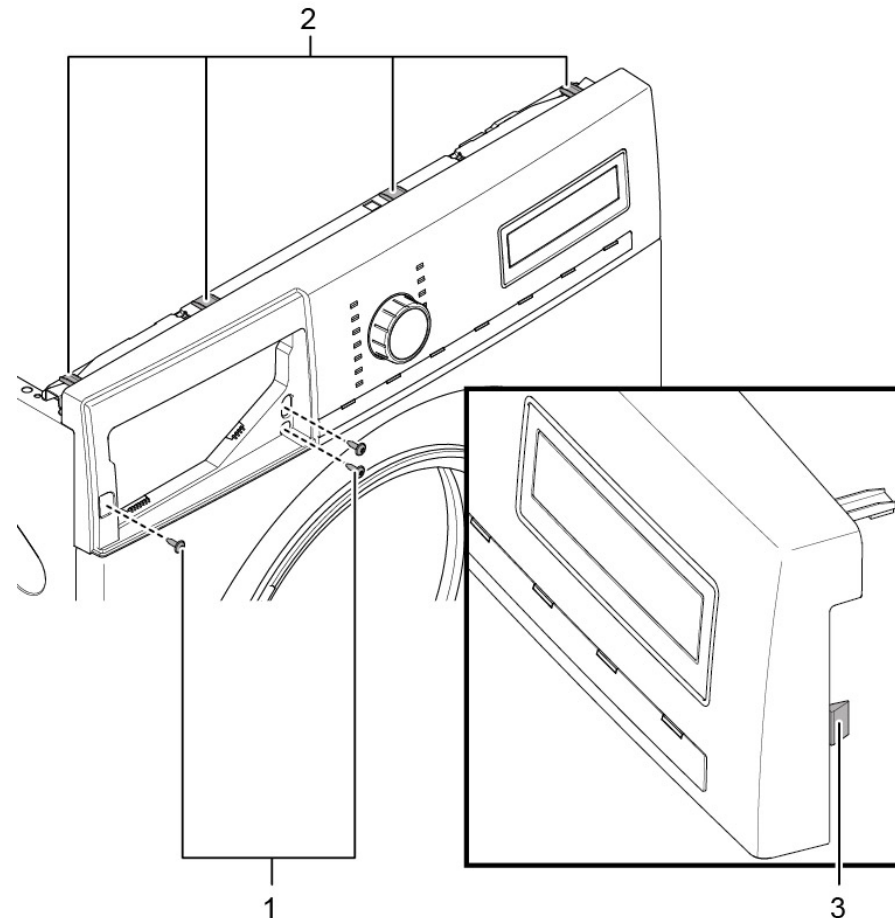

2. Irrota ohjausyksikön pistokekontakti.
3. Poista ohjauspaneeli.

## 4.4.2 Ohjauspaneelin asentaminen





Tarkasta johdon asennus. Johto voi olla jäänyt väliin.

- ▶ Asenna vastakkaisessa järjestyksessä.

## 4.5 Luukun vaihtaminen

	<b>⚠ HUOMAA</b> <b>Avoim saranan alue!</b> Sormien murskautuminen / jääminen väliin ▶ Älä koske saranan alueelle. ▶ Käytä suojakäsineitä.
--	---

	<b>⚠ HUOMAA</b> <b>Ruuvien avaamisesta aiheutuva osien putoamisen riski!</b> Loukkaantuminen putoavien osien vuoksi. ▶ Estä komponentin putoaminen.
--	--

	<b>⚠ HUOMIO!</b> <b>Ruuvien avaamisesta aiheutuva osien putoamisen riski!</b> Vauriot koneen muille osille tai asiakkaan kodille, esim. lattia. ▶ Estä komponentin putoaminen.
--	---

### Vaatus:

- ✔ Kone on erotettu tehollähteestä.
- ✔ Kone on erotettu vedenjakelusta.
- ✔ Luukku on avattu.

### 4.5.1 Luukun poistaminen

1. Poista ruuvit (1).

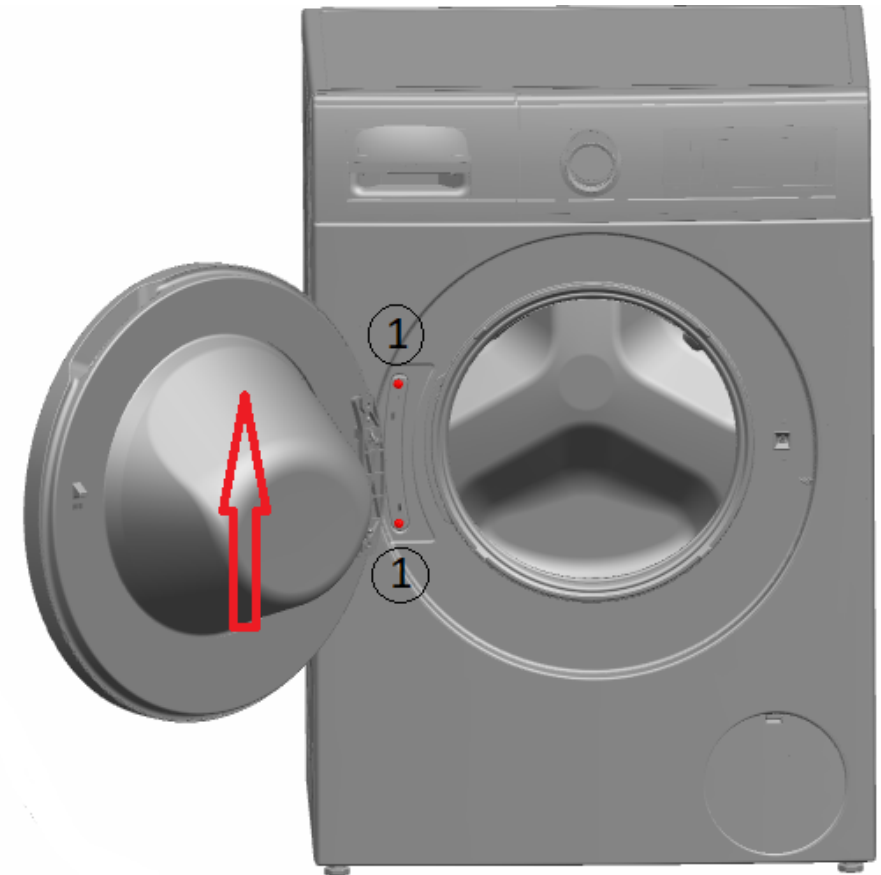



2. Poista luukku yläsuuntaan.

### 4.5.2 Luukun asennus

- ▶ Asenna vastakkaisessa järjestyksessä.

## 4.6 Luukun komponenttien vaihtaminen

	<p><b>VAROITUS</b></p> <p><b>Painavat ja liikkuvat komponentit!</b> Murskautumisen riski korjauksen, kunnossapidon, vianetsinnän ja huollon aikana</p> <ul style="list-style-type: none"><li>▶ Käytä suojakenkiä.</li><li>▶ Estä painavien komponenttien putoaminen.</li><li>▶ Älä koske liikkuviin komponentteihin.</li></ul>
--	--

	<p><b>HUOMAA</b></p> <p><b>Avoin saranan alue!</b> Sormien murskautuminen / jääminen väliin</p> <ul style="list-style-type: none"><li>▶ Älä koske saranan alueelle.</li><li>▶ Käytä suojakäsineitä.</li></ul>
--	---

### Vaatus:

- ✔ Kone on erotettu teholahteesta.
- ✔ Kone on erotettu vedenjakelusta.
- ✔ [Luukku on poistettu.→ 146](#)

### 4.6.1 Luukun komponenttien poistaminen

- ▶ Pura luukku osiin ulkoa sisäänpäin.

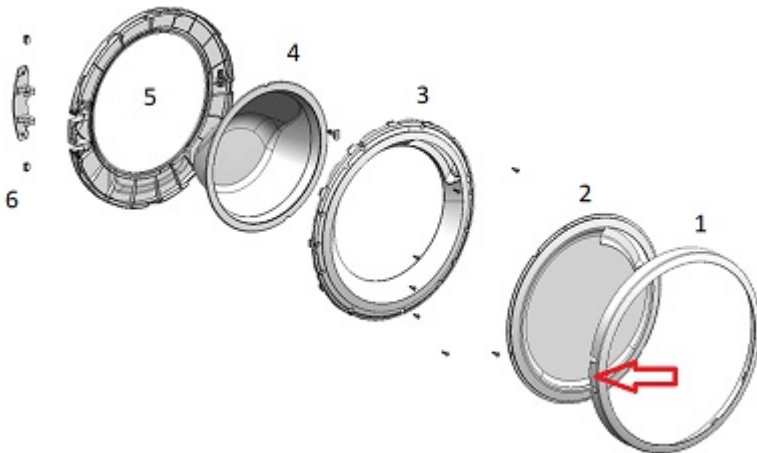

### 4.6.2 Luukun komponenttien asennus

- ▶ Asenna vastakkaisessa järjestyksessä.

## 4.7 Pumpun suojuksen vaihtaminen

### Vaatus:

- ✓ Kone on erotettu tehollähteestä.
- ✓ Kone on erotettu vedenjakelusta.

### 4.7.1 Pumpun suojuksen poistaminen

1. Avaa pumpun suojus.

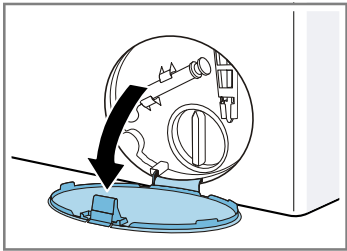

2. Poista pumpun suojus.

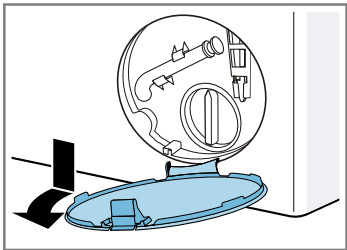



### 4.7.2 Pumpun suojuksen asennus

- ▶ Asenna vastakkaisessa järjestyksessä.

## 4.8 Luukun tiivisteiden vaihtaminen

	<b>⚠ HUOMAA</b> <b>Terävät kotelon reunat!</b> Viiltovammat ▶ Käytä suojakäsineitä.
--	--

	<b>⚠ HUOMAA</b> <b>Ruuvien avaamisesta aiheutuva osien putoamisen riski!</b> Loukkaantuminen putoavien osien vuoksi. ▶ Estä komponentin putoaminen.
--	--

	<b>HUOMIO!</b> <b>Ruuvien avaamisesta aiheutuva osien putoamisen riski!</b> Vauriot koneen muille osille tai asiakkaan kodille, esim. lattia. ▶ Estä komponentin putoaminen.
--	---

### Vaatus:

- ✔ Kone on erotettu tehollähteestä.
- ✔ Kone on erotettu vedenjakelusta.
- ✔ Koneeseen on vapaa pääsy.
- ✔ [Työtaso on poistettu.→141](#)
- ✔ [Pesuainelokero on poistettu.→142](#)
- ✔ [Ohjauspaneeli on poistettu.→144](#)
- ✔ [Luukku on poistettu.→146](#)
- ✔ [Pumpun suojus on poistettu.→148](#)
- ✔ [Etupaneeli on poistettu.→153](#)
- ✔ [Rummun valo on poistettu \(valinnainen\).→152](#)

## 4.8.1 Luukun tiivisteiden poistaminen

1. Irrota kaikki letkuliitännät.

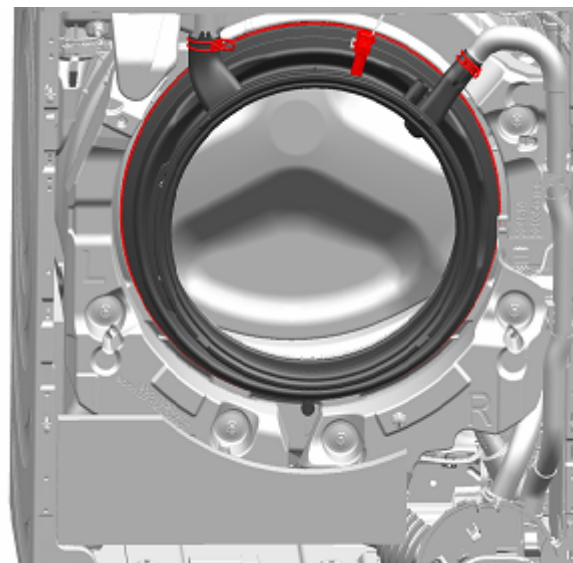

2. Poista luukun tiiviste.

## 4.8.2 Luukun tiivisteiden asennus

	<b>⚠ VAROITUS</b> <b>Väärästä asennuksesta aiheutuva osien putoamisen riski!</b> Loukkaantuminen tai laitteen vahingoittuminen. ▶ Kiristä kumitiivisteiden kiristysrenas 3,4 Nm:llä.
--	---

- ▶ Asenna vastakkaisessa järjestyksessä.

## 4.9 Luukun lukitsimen vaihtaminen

Valmistajana olemme velvoitettuja toimittamaan kuluttajille varaosana ovilukon sekä korjausohjeet (EU) 2019/2023 -säädöksen mukaisesti. Haluaisimme kuitenkin huomauttaa, että ovilukon vaihtamisen jälkeen pätevän sähköasentajan on testattava sähkötekninen turvallisuus ennen kuin laite otetaan uudelleen käyttöön. Tällä henkilöllä on oltava todistettavissa oleva pätevyys maan erityisten lakien, säädösten ja standardien mukaisesti.

	<b>VAARA</b>
	<p><b>Jännitteisten osien aiheuttama sähköiskun vaara!</b> Sähköiskusta aiheutuva hengenvaara väärän korjauksen tapauksessa</p> <ul style="list-style-type: none"> <li>▶ Sähköosien korjaus tulisi antaa pätevien sähköasentajien suorittavaksi.</li> <li>▶ Pyydä korjauksen jälkeen suorittamaan VDE 0701 -säädöksen tai maakontaisten säädösten mukainen turvallisuustesti.</li> </ul>

	<b>VAROITUS</b>
	<p><b>Kallistetun koneen luiskahtaminen!</b> Luunmurtumat/murskavammat</p> <ul style="list-style-type: none"> <li>▶ Estä koneiden luiskahtaminen.</li> </ul>

	<b>HUOMAA</b>
	<p><b>Terävät kotelon reunat!</b> Viiltovammat</p> <ul style="list-style-type: none"> <li>▶ Käytä suojakäsineitä.</li> </ul>

	<b>HUOMAA</b>
	<p><b>Ruuvien avaamisesta aiheutuva osien putoamisen riski!</b> Loukkaantuminen putoavien osien vuoksi.</p> <ul style="list-style-type: none"> <li>▶ Estä komponentin putoaminen.</li> </ul>

	<b>HUOMIO!</b>
	<p><b>Ruuvien avaamisesta aiheutuva osien putoamisen riski!</b> Vauriot koneen muille osille tai asiakkaan kodille, esim. lattia.</p> <ul style="list-style-type: none"> <li>▶ Estä komponentin putoaminen.</li> </ul>

### Vaatus:

- ✓ Kone on erotettu tehollähteestä.
- ✓ Kone on erotettu vedenjakelusta.

- ✓ Koneeseen on vapaa pääsy.
- ✓ [Työtaso on poistettu.→141](#)
- ✓ [Pesuainelokero on poistettu.→142](#)
- ✓ [Ohjauspaneeli on poistettu.→144](#)
- ✓ [Luukku on poistettu.→146](#)
- ✓ Kiristysrenkas on poistettu.
- ✓ [Luukun tiiviste on poistettu.→149](#)
- ✓ [Pumpun suojus on poistettu.→148](#)
- ✓ [Etupaneeli on poistettu.→153](#)

### 4.9.1 Luukun lukitsimen poistaminen

1. Irrota luukun lukitsimen pistotulppa.
2. Vapauta luukun lukitsin.



3. Poista luukun lukitsin.



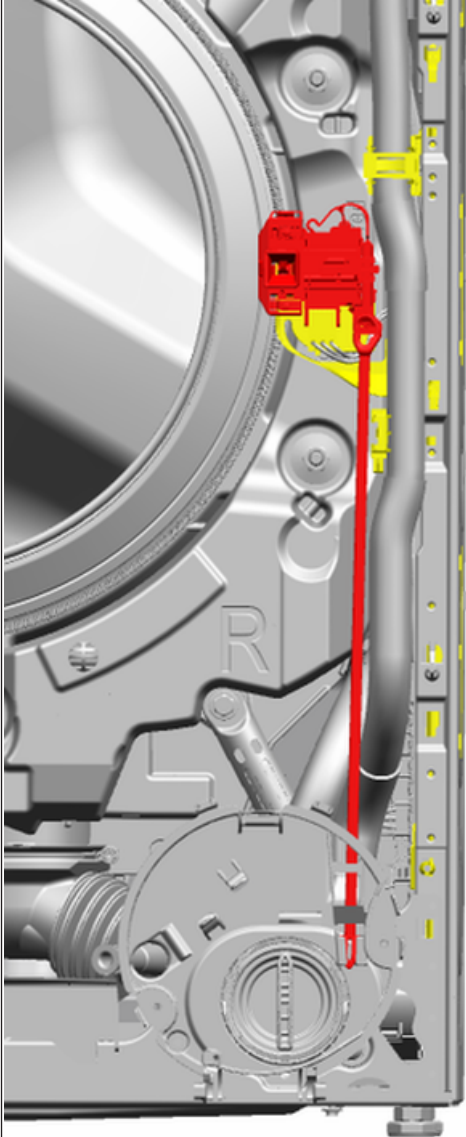

## 4.9.2 Luukun lukitsimen asennus

Luukun lukitsimen on oltava oikeassa asennossa, jotta koneen luukun hätäavaustoiminto on mahdollinen.



- ▶ Asenna vastakkaisessa järjestyksessä.

## 4.10 Rummun lampun vaihtaminen

	<p style="text-align: center;"><b>VAROITUS</b></p> <p><b>Kallistetun koneen luiskahtaminen!</b> Luunmurtumat/murskavammat</p> <ul style="list-style-type: none"> <li>▸ Estä koneiden luiskahtaminen.</li> </ul>
	<p style="text-align: center;"><b>HUOMAA</b></p> <p><b>Terävät kotelon reunat!</b> Viiltovammat</p> <ul style="list-style-type: none"> <li>▸ Käytä suojakäsineitä.</li> </ul>
	<p style="text-align: center;"><b>HUOMAA</b></p> <p><b>Ruuvien avaamisesta aiheutuva osien putoamisen riski!</b> Loukkaantuminen putoavien osien vuoksi.</p> <ul style="list-style-type: none"> <li>▸ Estä komponentin putoaminen.</li> </ul>
	<p style="text-align: center;"><b>HUOMIO!</b></p> <p><b>Ruuvien avaamisesta aiheutuva osien putoamisen riski!</b> Vauriot koneen muille osille tai asiakkaan kodille, esim. lattia.</p> <ul style="list-style-type: none"> <li>▸ Estä komponentin putoaminen.</li> </ul>

### Vaatus:

- ✔ Kone on erotettu teholahteesta.
- ✔ Kone on erotettu vedenjakelusta.
- ✔ Koneeseen on vapaa pääsy.
- ✔ [Työtaso on poistettu.→141](#)
- ✔ [Pesuainelokero on poistettu.→142](#)
- ✔ [Ohjauspaneeli on poistettu.→144](#)

### 4.10.1 Rummun lampun poistaminen

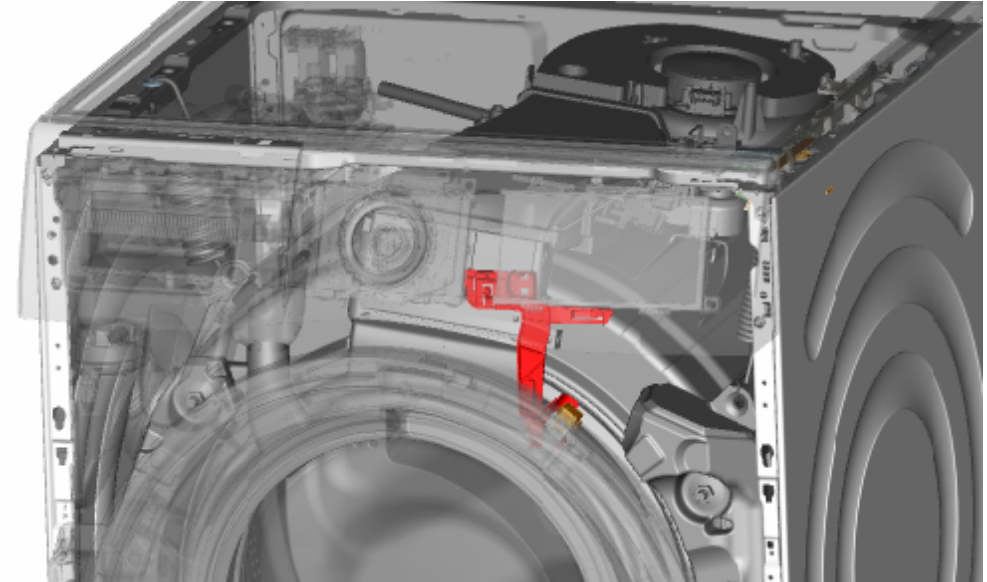





1. Vedä rummun lamppupidike ulos koneesta.
2. Irrota sähköliitännät.
3. Poista lamppu rummun lampunpidikkeestä.

### 4.10.2 Rummun lampun asennus

	<p>Tarkasta johdon asennus. Johto voi olla jäänyt väliin.</p>
---	---

- Asenna vastakkaisessa järjestyksessä.

## 4.11 Etupaneelin vaihtaminen

	<p style="text-align: center;"><b>VAROITUS</b></p> <p><b>Kallistetun koneen luiskahtaminen!</b> Luunmurtumat/murskavammat</p> <ul style="list-style-type: none"> <li>▶ Estä koneiden luiskahtaminen.</li> </ul>
	<p style="text-align: center;"><b>HUOMAA</b></p> <p><b>Terävät kotelon reunat!</b> Viiltovammat</p> <ul style="list-style-type: none"> <li>▶ Käytä suojakäsineitä.</li> </ul>
	<p style="text-align: center;"><b>HUOMAA</b></p> <p><b>Ruuvien avaamisesta aiheutuva osien putoamisen riski!</b> Loukkaantuminen putoavien osien vuoksi.</p> <ul style="list-style-type: none"> <li>▶ Estä komponentin putoaminen.</li> </ul>
	<p style="text-align: center;"><b>HUOMIO!</b></p> <p><b>Ruuvien avaamisesta aiheutuva osien putoamisen riski!</b> Vauriot koneen muille osille tai asiakkaan kodille, esim. lattia.</p> <ul style="list-style-type: none"> <li>▶ Estä komponentin putoaminen.</li> </ul>

### Vaatus:

- ✓ Kone on erotettu tehollähteestä.
- ✓ Kone on erotettu vedenjakelusta.
- ✓ Koneeseen on vapaa pääsy.
- ✓ [Työtaso on poistettu.→141](#)
- ✓ [Pesuainelokero on poistettu.→142](#)
- ✓ [Ohjauspaneeli on poistettu.→144](#)
- ✓ [Luukku on poistettu.→146](#)
- ✓ [Pumpun suojustus on poistettu.→148](#)
- ✓ Kiristysrenkas on poistettu.
- ✓ Luukun tiiviste on poistettu edessä.
- ✓ [Rummun valo on poistettu \(valinnainen\).→152](#)

### 4.11.1 Etupaneelin poistaminen

1. Nosta konetta ylös edestä.

2. Poista ruuvit alaosasta (1).

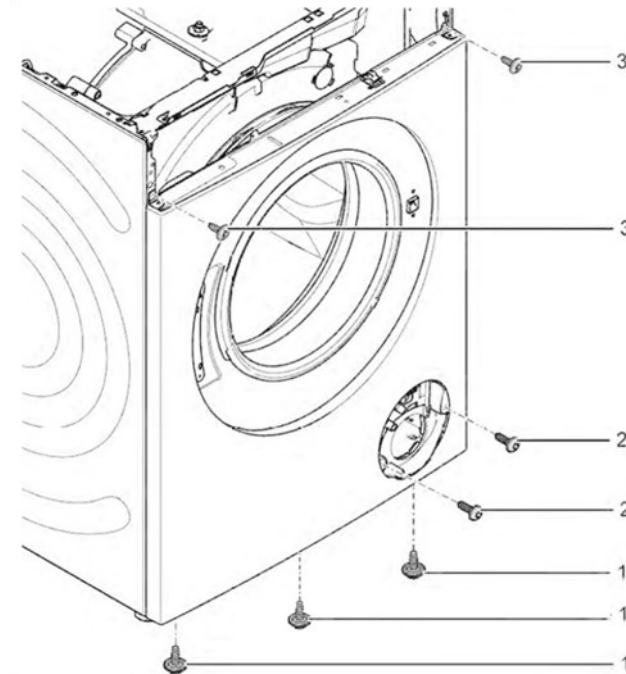

3. Laske kone alas.

4. Poista ruuvit edestä etenemällä alhaalta ylöspäin (2, 3).

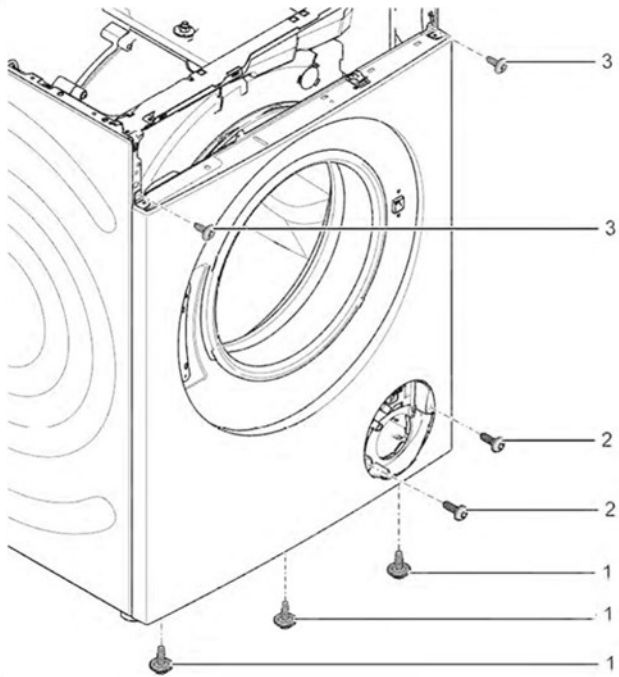

5. Poista etupaneeli.

## 4.11.2 Etupaneelin asentaminen

- ▶ Asenna vastakkaisessa järjestyksessä.

# Conseils de réparation - Lave-linge

## **A propos de ce document..... 156**

1.1 Informations importantes.....	156
1.1.1 Objectif.....	156
1.2 Explication des symboles.....	156
1.2.1 Niveaux de risque.....	156
1.2.2 Symboles de danger.....	156
1.2.3 Structure des indications d'avertissement.....	157
1.2.4 Symboles généraux.....	157

## **Sécurité..... 158**

2.1 Consignes de sécurité générales.....	158
2.1.1 Tous les appareils électroménagers.....	158

## **Outils et aides..... 159**

## **Réparation ..... 160**

4.1 Changer le dessus.....	160
4.1.1 Retirer le dessus.....	160
4.1.2 Monter le dessus.....	160
4.2 Changer le bac à produits.....	161
4.2.1 Retirer le bac à produits.....	161
4.2.2 Monter le bac à produits.....	161
4.3 Changer la poignée du bac à produits.....	162
4.3.1 Retirer la poignée du bac à produits.....	162
4.3.2 Monter la poignée du bac à produits.....	162
4.4 Changer le panneau de commande.....	163
4.4.1 Retirer le panneau de commande.....	163
4.4.2 Monter le panneau de commande.....	164
4.5 Changer la porte.....	165
4.5.1 Retirer la porte.....	165
4.5.2 Monter la porte.....	165
4.6 Changer les composants de la porte.....	166
4.6.1 Retirer les composants de la porte.....	166
4.6.2 Monter les composants de la porte.....	166
4.7 Changer le couvercle de la pompe.....	167
4.7.1 Retirer le couvercle de la pompe.....	167
4.7.2 Monter le couvercle de la pompe.....	167

4.8 Changer le joint de porte.....	168
4.8.1 Retirer le joint de porte.....	168
4.8.2 Monter le joint de porte.....	168
4.9 Echange de la fermeture de porte.....	169
4.9.1 Retrait de la fermeture de porte.....	169
4.9.2 Monter la fermeture de porte.....	170
4.10 Changer la lumière du tambour.....	171
4.10.1 Retirer la lumière du tambour.....	171
4.10.2 Monter la lumière du tambour.....	171
4.11 Changer le panneau de façade.....	172
4.11.1 Retirer le panneau de façade.....	172
4.11.2 Monter le panneau de façade.....	173

# **i** A propos de ce document

## 1.1 Informations importantes

### 1.1.1 Objectif

Les conseils de réparation qui suivent aident le consommateur à réparer l'appareil par lui-même, conformément au règlement sur l'écoconception (en vigueur en 03/2021).

Ils contiennent des informations sur l'échange de certaines pièces détachées, ainsi que des avertissements et risques.

Pour toute question, veuillez contacter notre service après-vente. Nous ne serons responsables des dommages que si les indications de réparation ont été suivies correctement.

## 1.2 Explication des symboles

### 1.2.1 Niveaux de risque

Les niveaux de risque se composent d'un symbole et d'un terme d'avertissement. Le mot d'avertissement caractérise la gravité du danger.









Niveau de dangerosité	Signification
 <b>DANGER</b>	Le non respect de la consigne d'avertissement provoque la mort ou des blessures graves.
 <b>AVERTISSEMENT</b>	Le non respect de la consigne d'avertissement peut provoquer la mort ou des blessures graves.
 <b>PRUDENCE</b>	Le non respect de la consigne d'avertissement peut provoquer des blessures légères.
 <b>ATTENTION !</b>	Le non respect de la consigne d'avertissement peut provoquer des dégâts matériels.

Tableau 1: Niveaux de risque

### 1.2.2 Symboles de danger

Les symboles de danger sont des représentations figuratives renseignant sur la nature du danger.

Ce document utilise les symboles de danger suivants:

Symbole de danger	Signification
	Consigne d'avertissement générale
	Danger engendré par la tension électrique
	Risque d'explosion
	Risque de blessures par coupure

## **i** A propos de ce document





Symbole de danger	Signification
	Risque de blessures par écrasement
	Danger engendré par des surfaces très chaudes
	Danger engendré par un champ magnétique puissant
	Danger engendré par un rayonnement non ionisant

Tableau 2: Symboles de danger

### 1.2.3 Structure des indications d'avertissement

Les consignes d'avertissement figurant dans ce document ont un aspect uniforme et une structure uniforme.

	<div style="background-color: red; color: white; padding: 2px; text-align: center;"><b>⚠ DANGER</b></div> <p><b>Type et source du danger !</b> Conséquences possibles en cas de non-respect du danger / de l'avertissement.</p> <ul style="list-style-type: none"> <li>▶ Mesures et interdictions pour éviter le danger.</li> </ul>
--	---

L'exemple suivant montre une consigne d'avertissement mettant en garde contre le risque d'électrocution. La mesure permettant d'éviter le danger est nommée.

	<div style="background-color: red; color: white; padding: 2px; text-align: center;"><b>⚠ DANGER</b></div> <p><b>Risque d'électrocution par des pièces conductrices de tension !</b> Mort par électrocution.</p> <ul style="list-style-type: none"> <li>▶ Débrancher l'appareil du secteur minimum 60 secondes avant de démarrer la réparation.</li> </ul>
--	---

### 1.2.4 Symboles généraux

Ce document utilise les symboles généraux suivants:







Symbole général	Signification
	Caractérisation d'une astuce particulière (texte et/ou graphique)
	Caractérisation d'une astuce simple (texte seul)
	Caractérisation d'un lien vers une vidéo
	Caractérisation d'outils nécessaires
	Caractérisation de conditions nécessaires
	Caractérisation d'une condition (si... , alors ...)
	Caractérisation d'un résultat
Start	Caractérisation d'une touche ou surface de commande
[00123456]	Caractérisation d'une référence de pièce
Statut	Caractérisation d'un texte affiché / fenêtre (sur l'afficheur)

Tableau 3: Symboles généraux

## 2.1 Consignes de sécurité générales

### 2.1.1 Tous les appareils électroménagers

#### **Risque d'électrocution en raison de pièces sous tension!**

- Des erreurs lors de réparations impliquant des composants électriques peuvent entraîner une décharge électrique!
- Débrancher l'appareil du secteur minimum 60 secondes avant de démarrer la réparation.
- Après la réparation, effectuer un test de sécurité selon VDE 0701 ou les réglementations spécifiques nationales.

#### **Risque de blessures par coupure sur des bords tranchants!**

- Porter des gants de protection.

#### **Risque de casse durant la réparation, maintenance, dépannage et SAV en raison de composants lourds et mobiles**

- Porter des chaussures de protection.
- Sécuriser les composants lourds contre le risque de chute.
- Ne pas coller les pièces du châssis sur les composants mobiles.







#### **Risque lié à la sécurité / fonction de l'appareil!**

- Utiliser uniquement des pièces détachées d'origine.

#### **Risque d'endommagement des composants sensibles aux décharges électrostatiques!**

- Ne pas toucher les modules, ni leur connexions et pistes conductrices.

## Outils et aides

Désignation	Détails	Images
Outil auxiliaire [15000155]	Cale de montage pour démonter les pièces en plastique	
Tournevis Torx T20 avec perçage [00340764]	100 mm , pour les vis avec la tige de sécurité	
Clé dynamométrique [15000441]	Clé dynamométrique 20 - 100 Nm	
Tournevis plat [00340854]	Lame 3.5 mm x 0.6 mm x 100 mm, Isolation de protection 1000 V AC	
Tournevis plat [00340855]	Lame 5.5 mm x 1.0 mm x 125 mm, isolation de protection 1000 V AC	
Pince à bec fin, angulaire [00341269]	Longueur 200 mm	
Pince coupante [00342182]	Longueur: 200 mm	



Désignation	Détails	Images
Clé mixte [00340811]	Taille de la clé 10°mm, M6	
Combination wrench [00340814]	Taille de la clé 13°mm, M8	
Clé mixte [00340817]	Taille de la clé 17 mm, M10	
Clé mixte [15000459]	Taille de la clé 16°mm, M10	

## 4.1 Changer le dessus

### Outillage nécessaire:

-  Embout tournevis Torx TX20 avec trou      Longueur 152 mm, longueur utilisable [00341272] 124 mm, 1/4" entraînement hexagonal (6.35 mm), pour vis avec broche de sécurité

### Pré-requis:

-  Appareil n'est pas sous tension.
-  L'appareil n'est pas connecté à une alimentation en eau.

### 4.1.1 Retirer le dessus

- ▶ 1. Retirer les vis (1).
- ▶ 2. Repousser le dessus vers l'arrière l'appareil (2).
- ▶ 3. Soulever le dessus (3) pour le retirer.

### 4.1.2 Monter le dessus



Observer les instructions d'installation du câble. Le câble pourrait être coincé.

- ▶ Le montage s'effectue dans l'ordre chronologique inverse.

## 4.2 Changer le bac à produits

### Pré-requis:

- ✓ Appareil n'est pas sous tension.
- ✓ L'appareil n'est pas connecté à une alimentation en eau.

### 4.2.1 Retirer le bac à produits

1. Ouvrir le bac à produits.
2. 1. Appuyer dessus pour l'insérer (1).  
2. Retirer le bac à produits (2).

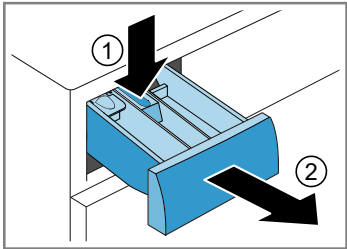

### 4.2.2 Monter le bac à produits

- ▶ Le montage s'effectue dans l'ordre chronologique inverse.

## 4.3 Changer la poignée du bac à produits

### Pré-requis:

- ✓ Appareil n'est pas sous tension.
- ✓ L'appareil n'est pas connecté à une alimentation en eau.
- ✓ [Bac à produits retiré. → 161](#)

### 4.3.1 Retirer la poignée du bac à produits

1. Retirer les éléments de fixation.

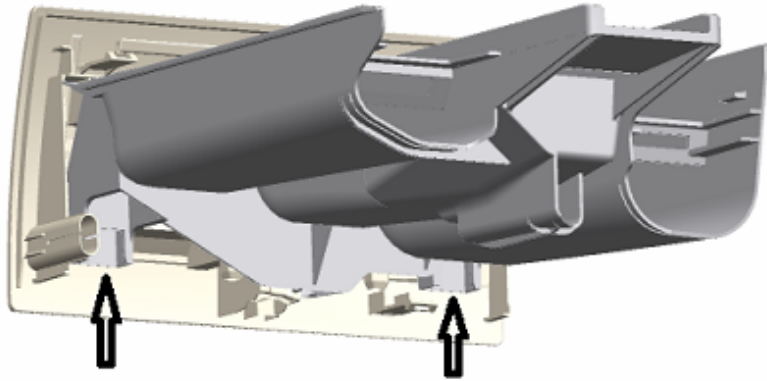

2. Retirer la poignée du bac à produits.

### 4.3.2 Monter la poignée du bac à produits

- ▶ Le montage s'effectue dans l'ordre chronologique inverse.

## 4.4 Changer le panneau de commande

En tant que fabricant, nous sommes obligés de fournir aux clients la pièce de rechange de panneau de commande incluant les instructions de réparation selon la réglementation (EU) 2019/2023. Toutefois, nous aimerions mentionner la nécessité d'effectuer un test électrotechnique par un électricien qualifié, après l'échange d'un panneau de commande, avant la mise en service de l'appareil. Cette personne doit être qualifiée selon les lois et normes nationales spécifiques, de façon vérifiable.

	<b>⚠ DANGER</b>
	<b>Risque d'électrocution en raison de pièces sous tension !</b> Risque d'électrocution en cas de réparation non conforme <ul style="list-style-type: none"><li>▶ Les pièces électriques doivent être réparées par des techniciens qualifiés.</li><li>▶ Après la réparation, effectuer un test de sécurité selon VDE 0701 ou les réglementations spécifiques nationales.</li></ul>

	<b>⚠ AVERTISSEMENT</b>
	<b>Chute d'appareils inclinés !</b> Fractures/blessures d'écrasement <ul style="list-style-type: none"><li>▶ Sécuriser les appareils contre le risque de chute.</li></ul>

	<b>⚠ PRUDENCE</b>
	<b>Bords tranchants du boîtier !</b> Risque de coupures! <ul style="list-style-type: none"><li>▶ Porter des gants de protection.</li></ul>

	<b>⚠ PRUDENCE</b>
	<b>Risque de pièces qui chutent en raison de vis trop lâches !</b> Blessures dues à des pièces qui chutent. <ul style="list-style-type: none"><li>▶ Sécuriser les composants contre le risque de chute.</li></ul>

	<b>ATTENTION !</b>
	<b>Risque de pièces qui chutent en raison de vis trop lâches !</b> Dommages à d'autres parties de l'appareil ou à la propriété du client, p. ex. au plancher. <ul style="list-style-type: none"><li>▶ Sécuriser les composants contre le risque de chute.</li></ul>

### Pré-requis:

- ✓ Appareil n'est pas sous tension.

- ✓ L'appareil n'est pas connecté à une alimentation en eau.
- ✓ [Le plan de travail a été retiré. → 160](#)
- ✓ [Bac à produits retiré. → 161](#)

### 4.4.1 Retirer le panneau de commande

1. Retirer les vis (1).
2. Retirer les éléments de fixation (2, 3).

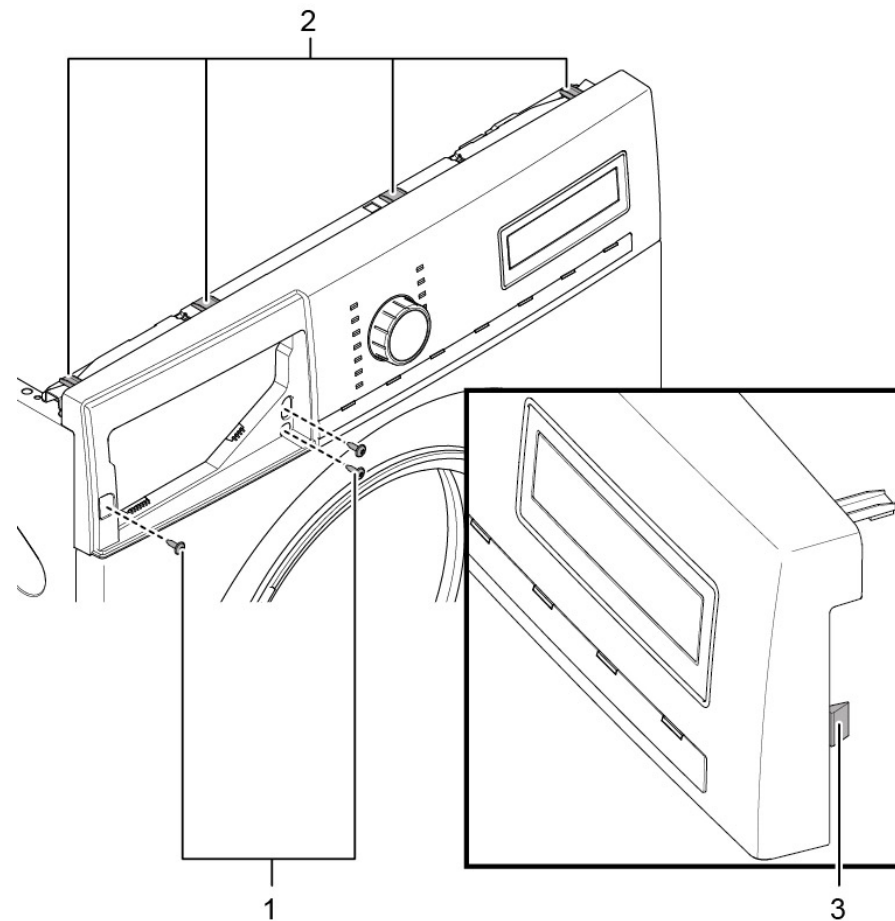

2. Relâcher le contact à fiche de l'unité de commande.
3. Retirer le panneau de commande.

### 4.4.2 Monter le panneau de commande



Observer les instructions d'installation du câble. Le câble pourrait être coincé.

- ▶ Le montage s'effectue dans l'ordre chronologique inverse.

## 4.5 Changer la porte



### PRUDENCE

#### Ouvrir la zone de charnière !

Écrasement/coincement des doigts

- ▶ Ne pas insérer les doigts dans la zone de la charnière.
- ▶ Porter des gants de protection.



### PRUDENCE

#### Risque de pièces qui chutent en raison de vis trop lâches !

Blessures dues à des pièces qui chutent.

- ▶ Sécuriser les composants contre le risque de chute.



### ATTENTION !

#### Risque de pièces qui chutent en raison de vis trop lâches !

Domages à d'autres parties de l'appareil ou à la propriété du client, p. ex. au plancher.

- ▶ Sécuriser les composants contre le risque de chute.

#### Pré-requis:

- ✔ Appareil n'est pas sous tension.
- ✔ L'appareil n'est pas connecté à une alimentation en eau.
- ✔ La porte est ouverte.

### 4.5.1 Retirer la porte

1. Retirer les vis (1).

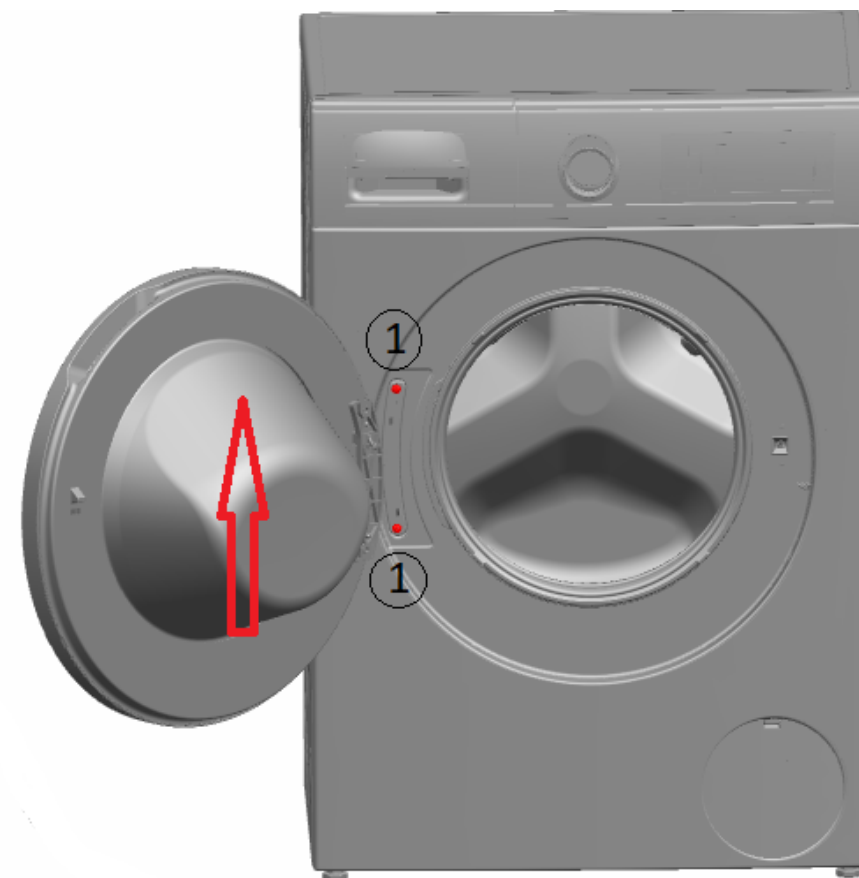



2. Retirer la porte en la soulevant.

### 4.5.2 Monter la porte

- ▶ Le montage s'effectue dans l'ordre chronologique inverse.

## 4.6 Changer les composants de la porte

	<b>⚠ AVERTISSEMENT</b>
	<b>Composants lourds et mobiles !</b> Risque d'écrasement durant la réparation, la maintenance, le dépannage et le SAV <ul style="list-style-type: none"><li>▶ Porter des chaussures de protection.</li><li>▶ Prévenir tout risque de chute des composants lourds.</li><li>▶ Ne pas coller les pièces du châssis sur les composants mobiles.</li></ul>

	<b>⚠ PRUDENCE</b>
	<b>Ouvrir la zone de charnière !</b> Écrasement/coincement des doigts <ul style="list-style-type: none"><li>▶ Ne pas insérer les doigts dans la zone de la charnière.</li><li>▶ Porter des gants de protection.</li></ul>

### Pré-requis:

- ✓ Appareil n'est pas sous tension.
- ✓ L'appareil n'est pas connecté à une alimentation en eau.
- ✓ [Porte a été retirée.→ 165](#)

### 4.6.1 Retirer les composants de la porte

- ▶ Démontez la porte de l'extérieur vers l'intérieur.

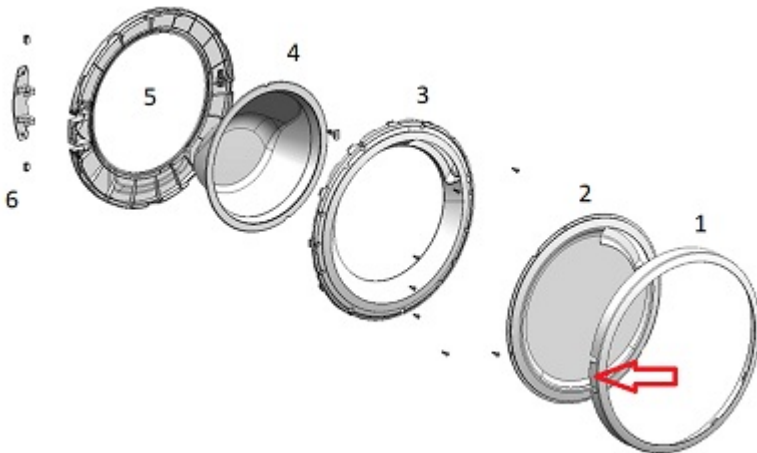

### 4.6.2 Monter les composants de la porte

- ▶ Le montage s'effectue dans l'ordre chronologique inverse.

## 4.7 Changer le couvercle de la pompe

### Pré-requis:

- ✓ Appareil n'est pas sous tension.
- ✓ L'appareil n'est pas connecté à une alimentation en eau.

### 4.7.1 Retirer le couvercle de la pompe

1. Ouvrir le couvercle de la pompe.

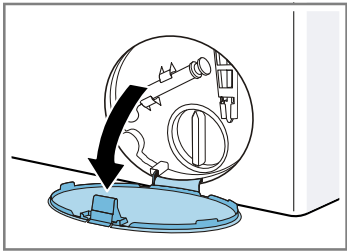

2. Retirer le couvercle de la pompe.

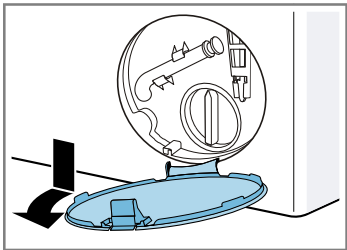

### 4.7.2 Monter le couvercle de la pompe

- ▶ Le montage s'effectue dans l'ordre chronologique inverse.

## 4.8 Changer le joint de porte



### ⚠️ PRUDENCE

**Bords tranchants du boîtier !**  
Risque de coupures!  
▶ Porter des gants de protection.



### ⚠️ PRUDENCE

**Risque de pièces qui chutent en raison de vis trop lâches !**  
Blessures dues à des pièces qui chutent.  
▶ Sécuriser les composants contre le risque de chute.



### ATTENTION !

**Risque de pièces qui chutent en raison de vis trop lâches !**  
Dommages à d'autres parties de l'appareil ou à la propriété du client, p. ex. au plancher.  
▶ Sécuriser les composants contre le risque de chute.

### Pré-requis:

- ✓ Appareil n'est pas sous tension.
- ✓ L'appareil n'est pas connecté à une alimentation en eau.
- ✓ L'appareil est librement accessible.
- ✓ [Le plan de travail a été retiré.→160](#)
- ✓ [Bac à produits retiré.→161](#)
- ✓ [Le panneau de commande a été retiré.→163](#)
- ✓ [Porte a été retirée.→165](#)
- ✓ [Couvercle de la pompe a été retiré.→167](#)
- ✓ [Le panneau de façade a été retiré.→172](#)
- ✓ [La lumière du tambour a été retirée \(facultatif\).→171](#)

### 4.8.1 Retirer le joint de porte

1. Retirer tous les raccords de flexibles.

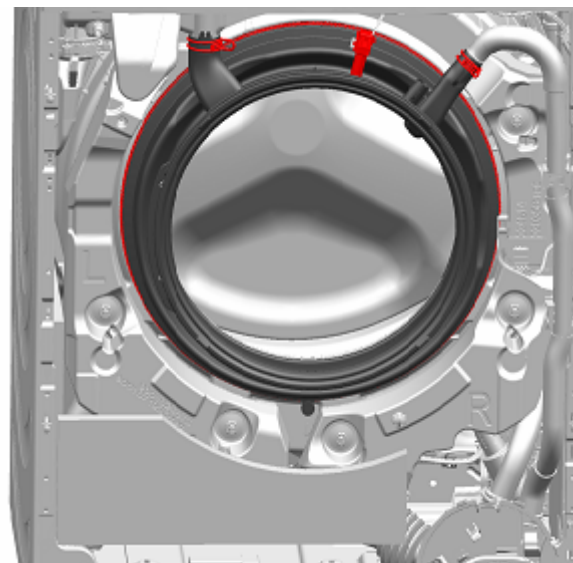

2. Retirer le joint de porte.

### 4.8.2 Monter le joint de porte



### ⚠️ AVERTISSEMENT

**Risque de chute de pièces en cas d'installation incorrecte !**  
Risque de blessure ou endommagement de l'appareil.  
▶ Serrer l'anneau de tension du joint de 3,4 Nm.

- ▶ Le montage s'effectue dans l'ordre chronologique inverse.

## 4.9 Echange de la fermeture de porte

En tant que fabricant, nous sommes obligés de fournir aux clients la fermeture de porte SAV incluant les instructions de réparation selon la réglementation (EU) 2019/2023. Toutefois, nous aimerions mentionner la nécessité d'effectuer un test électrotechnique par un électricien qualifié, après l'échange d'une fermeture de porte, avant la mise en service de l'appareil. Cette personne doit être qualifiée selon les lois et normes nationales spécifiques, de façon vérifiable.

	<b>⚠ DANGER</b>
	<b>Risque d'électrocution en raison de pièces sous tension !</b> Risque d'électrocution en cas de réparation non conforme <ul style="list-style-type: none"><li>▶ Les pièces électriques doivent être réparées par des techniciens qualifiés.</li><li>▶ Après la réparation, effectuer un test de sécurité selon VDE 0701 ou les réglementations spécifiques nationales.</li></ul>

	<b>⚠ AVERTISSEMENT</b>
	<b>Chute d'appareils inclinés !</b> Fractures/blessures d'écrasement <ul style="list-style-type: none"><li>▶ Sécuriser les appareils contre le risque de chute.</li></ul>

	<b>⚠ PRUDENCE</b>
	<b>Bords tranchants du boîtier !</b> Risque de coupures! <ul style="list-style-type: none"><li>▶ Porter des gants de protection.</li></ul>

	<b>⚠ PRUDENCE</b>
	<b>Risque de pièces qui chutent en raison de vis trop lâches !</b> Blessures dues à des pièces qui chutent. <ul style="list-style-type: none"><li>▶ Sécuriser les composants contre le risque de chute.</li></ul>

	<b>ATTENTION !</b>
	<b>Risque de pièces qui chutent en raison de vis trop lâches !</b> Dommages à d'autres parties de l'appareil ou à la propriété du client, p. ex. au plancher. <ul style="list-style-type: none"><li>▶ Sécuriser les composants contre le risque de chute.</li></ul>

### Pré-requis:

- ✓ Appareil n'est pas sous tension.

- ✓ L'appareil n'est pas connecté à une alimentation en eau.
- ✓ L'appareil est librement accessible.
- ✓ [Le plan de travail a été retiré.→160](#)
- ✓ [Bac à produits retiré.→161](#)
- ✓ [Le panneau de commande a été retiré.→163](#)
- ✓ [Porte a été retirée.→165](#)
- ✓ Collier de serrage a été retiré.
- ✓ [Le joint de porte a été retiré.→168](#)
- ✓ [Couvercle de la pompe a été retiré.→167](#)
- ✓ [Le panneau de façade a été retiré.→172](#)

### 4.9.1 Retrait de la fermeture de porte

1. Débrancher la prise de la fermeture de porte.
2. Défaire la fermeture de porte.



3. Retirer la fermeture de porte.

### 4.9.2 Monter la fermeture de porte

La fermeture de porte doit être dans la bonne position pour garantir la fonction d'ouverture d'urgence de la porte de l'appareil.

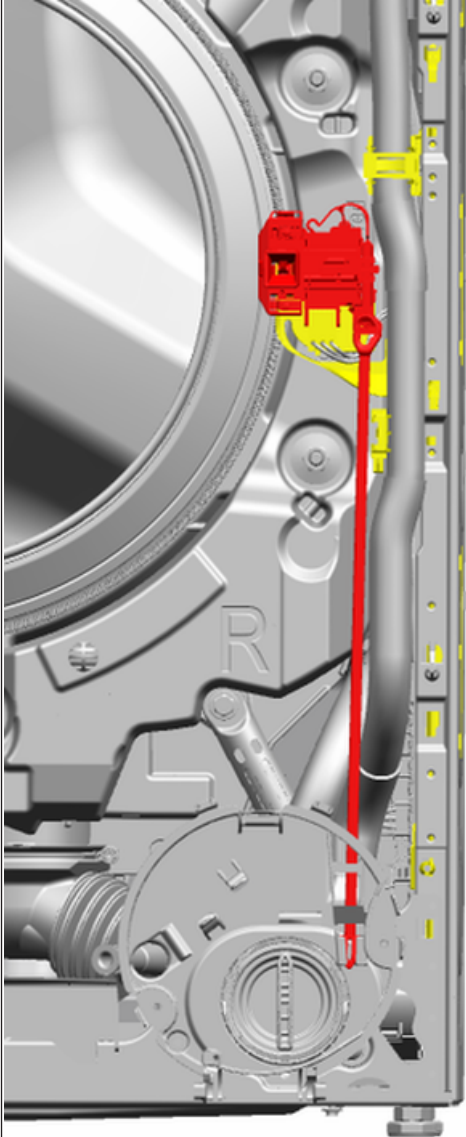

- ▶ Le montage s'effectue dans l'ordre chronologique inverse.

## 4.10 Changer la lumière du tambour



### ⚠️ AVERTISSEMENT

#### Chute d'appareils inclinés !

Fractures/blessures d'écrasement

- ▶ Sécuriser les appareils contre le risque de chute.



### ⚠️ PRUDENCE

#### Bords tranchants du boîtier !

Risque de coupures!

- ▶ Porter des gants de protection.



### ⚠️ PRUDENCE

#### Risque de pièces qui chutent en raison de vis trop lâches !

Blessures dues à des pièces qui chutent.

- ▶ Sécuriser les composants contre le risque de chute.



### ⚠️ ATTENTION !

#### Risque de pièces qui chutent en raison de vis trop lâches !

Dommages à d'autres parties de l'appareil ou à la propriété du client, p. ex. au plancher.

- ▶ Sécuriser les composants contre le risque de chute.

#### Pré-requis:

- ✓ Appareil n'est pas sous tension.
- ✓ L'appareil n'est pas connecté à une alimentation en eau.
- ✓ L'appareil est librement accessible.
- ✓ [Le plan de travail a été retiré. → 160](#)
- ✓ [Bac à produits retiré. → 161](#)
- ✓ [Le panneau de commande a été retiré. → 163](#)

### 4.10.1 Retirer la lumière du tambour

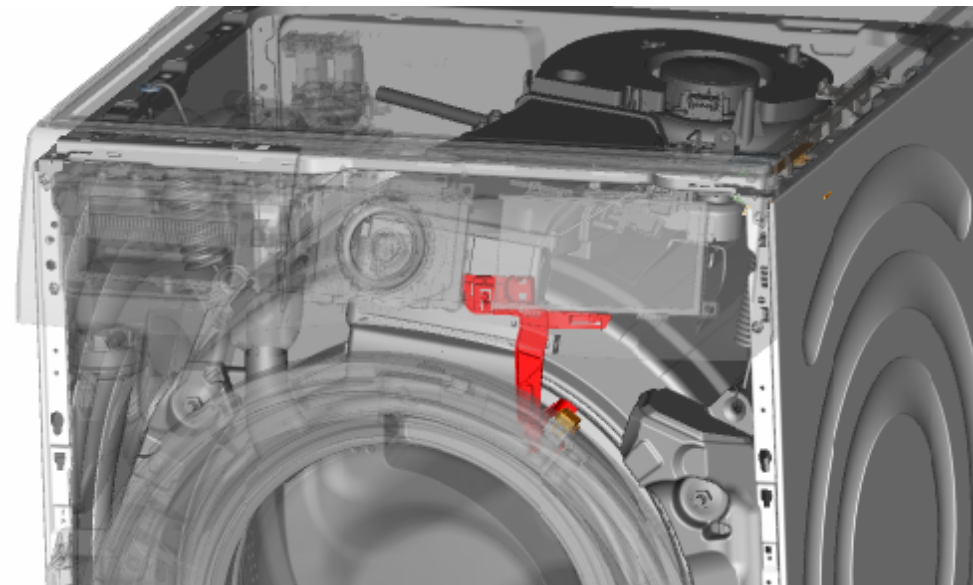

1. Sortir le support de la lumière du tambour de l'appareil.
2. Débrancher les connexions électriques.
3. Retirer la lumière du tambour de son support.

### 4.10.2 Monter la lumière du tambour



Observer les instructions d'installation du câble. Le câble pourrait être coincé.

- ▶ Le montage s'effectue dans l'ordre chronologique inverse.

## 4.11 Changer le panneau de façade



### ⚠️ AVERTISSEMENT

#### Chute d'appareils inclinés !

Fractures/blessures d'écrasement

- ▶ Sécuriser les appareils contre le risque de chute.



### ⚠️ PRUDENCE

#### Bords tranchants du boîtier !

Risque de coupures!

- ▶ Porter des gants de protection.



### ⚠️ PRUDENCE

#### Risque de pièces qui chutent en raison de vis trop lâches !

Blessures dues à des pièces qui chutent.

- ▶ Sécuriser les composants contre le risque de chute.



### ⚠️ ATTENTION !

#### Risque de pièces qui chutent en raison de vis trop lâches !

Dommages à d'autres parties de l'appareil ou à la propriété du client, p. ex. au plancher.

- ▶ Sécuriser les composants contre le risque de chute.

#### Pré-requis:

- ✓ Appareil n'est pas sous tension.
- ✓ L'appareil n'est pas connecté à une alimentation en eau.
- ✓ L'appareil est librement accessible.
- ✓ [Le plan de travail a été retiré. → 160](#)
- ✓ [Bac à produits retiré. → 161](#)
- ✓ [Le panneau de commande a été retiré. → 163](#)
- ✓ [Porte a été retirée. → 165](#)
- ✓ [Couvercle de la pompe a été retiré. → 167](#)
- ✓ Collier de serrage a été retiré.
- ✓ Le joint de porte a été retiré à l'avant.
- ✓ [La lumière du tambour a été retirée \(facultatif\). → 171](#)

### 4.11.1 Retirer le panneau de façade

1. Soulever l'appareil par l'avant.
2. Retirer les vis dans la portion inférieure (1).

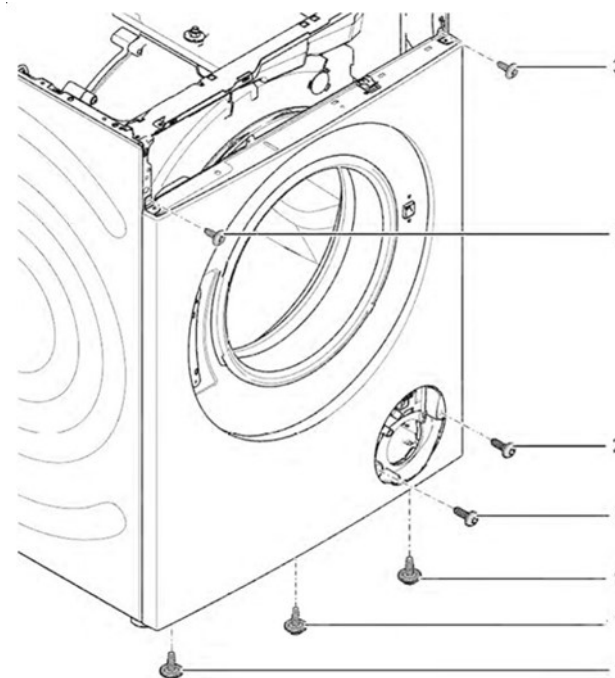

3. Abaisser l'appareil.

4. Retirer les vis à l'avant à partir du bas (2, 3).

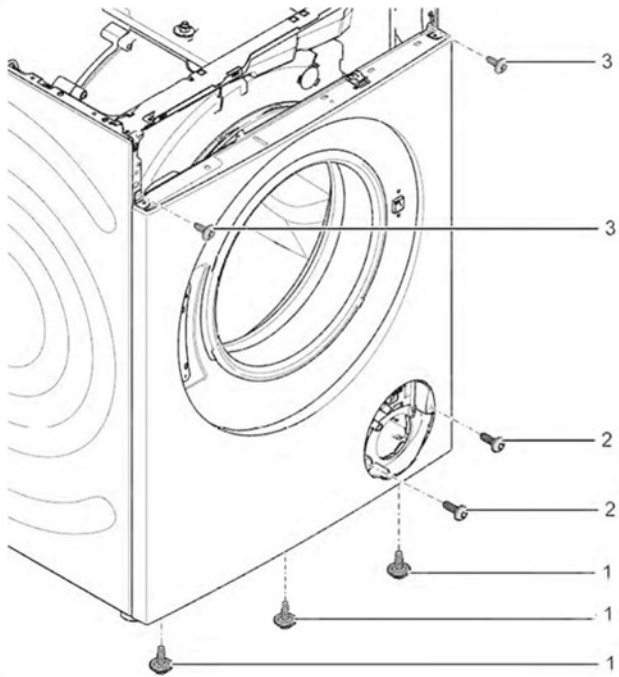





5. Retirer le bandeau de façade.

### 4.11.2 Monter le panneau de façade

- Le montage s'effectue dans l'ordre chronologique inverse.

# Reparatur Hinweise - Waschmaschine

 <b>Zu diesem Dokument</b> .....	<b>175</b>
1.1 Wichtige Hinweise: .....	175
1.1.1 Zweck .....	175
1.2 Zeichenerklärung.....	175
1.2.1 Gefahrenstufen .....	175
1.2.2 Gefahrensymbole.....	175
1.2.3 Struktur der Warnhinweise.....	176
1.2.4 Allgemeine Symbole .....	176
 <b>Sicherheit</b> .....	<b>177</b>
2.1 Allgemeine Sicherheitshinweise .....	177
2.1.1 Alle Hausgeräte .....	177
 <b>Werkzeuge und Hilfsmittel</b> .....	<b>178</b>
 <b>Instandsetzen</b> .....	<b>179</b>
4.1 Arbeitsplatte tauschen .....	179
4.1.1 Arbeitsplatte demontieren.....	179
4.1.2 Arbeitsplatte montieren.....	179
4.2 Austauschen der Waschmittelschublade .....	180
4.2.1 Ausbauen der Waschmittelschublade.....	180
4.2.2 Einbauen der Waschmittelschublade.....	180
4.3 Austauschen des Griffs der Waschmittelschublade.....	181
4.3.1 Ausbauen des Griffs der Waschmittelschublade .....	181
4.3.2 Einbauen des Griffs der Waschmittelschublade .....	181
4.4 Austauschen der Bedienblende .....	182
4.4.1 Ausbauen der Bedienblende.....	182
4.4.2 Einbauen der Bedienblende.....	183
4.5 Tür austauschen.....	184
4.5.1 Ausbauen der Tür .....	184
4.5.2 Einbauen der Tür .....	184
4.6 Austauschen der Türkomponenten .....	185
4.6.1 Ausbauen der Türkomponenten .....	185
4.6.2 Einbauen der Türkomponenten .....	185
4.7 Austauschen der Pumpenabdeckung.....	186
4.7.1 Ausbauen der Pumpenabdeckung .....	186
4.7.2 Einbauen der Pumpenabdeckung .....	186

4.8 Austauschen der Türdichtung .....	187
4.8.1 Ausbauen der Türdichtung .....	187
4.8.2 Einbauen der Türdichtung .....	187
4.9 Austauschen der Türverriegelung .....	188
4.9.1 Türverriegelung demontieren.....	188
4.9.2 Türverriegelung montieren .....	189
4.10 Austauschen der Trommelbeleuchtung .....	191
4.10.1 Ausbauen der Trommelbeleuchtung .....	191
4.10.2 Einbauen der Trommelbeleuchtung .....	191
4.11 Austauschen der Frontblende .....	192
4.11.1 Ausbauen der Frontblende.....	192
4.11.2 Einbauen der Frontblende.....	193

# Zu diesem Dokument

## 1.1 Wichtige Hinweise:

### 1.1.1 Zweck

Diese Reparaturhinweise dienen zur Unterstützung des Kunden bei der selbständigen Geräte-Reparatur gemäß der entsprechenden Ökodesign-Richtlinie (ab 03/2021).

Sie enthalten Informationen zum Austausch bestimmter Ersatzteile sowie Warn- und Gefahrenhinweise.

Bitte wenden Sie sich in Zweifelsfällen an unseren Kundendienst. Bei nicht ordnungsgemäßer Befolgung der Reparaturhinweise ist die Schadenshaftung ausgeschlossen.

## 1.2 Zeichenerklärung

### 1.2.1 Gefahrenstufen

Die Gefahrenstufen bestehen aus einem Symbol und einem Signalwort. Das Signalwort kennzeichnet die Schwere der Gefahr.









Gefahrenstufe	Bedeutung
	Nichtbeachtung des Warnhinweises führt zu Tod oder schweren Verletzungen.
	Nichtbeachtung des Warnhinweises kann zu Tod oder schweren Verletzungen führen.
	Nichtbeachtung des Warnhinweises kann zu leichten Verletzungen führen.
	Nichtbeachtung des Warnhinweises kann zu Sachschäden führen.

Tabelle 1: Gefahrenstufen

### 1.2.2 Gefahrensymbole

Gefahrensymbole sind sinnbildliche Darstellungen, die einen Hinweis auf die Art der Gefahr geben.

In diesem Dokument werden folgende Gefahrensymbole verwendet:

Gefahrensymbol	Bedeutung
	Allgemeiner Warnhinweis
	Gefahr durch elektrische Spannung
	Gefahr durch Explosion
	Gefahr von Schnittverletzungen
	Gefahr von Quetschverletzungen

## **i** Zu diesem Dokument





Gefahrensymbol	Bedeutung
	Gefahr durch heiße Oberflächen
	Gefahr durch starkes Magnetfeld
	Gefahr durch nicht ionisierende Strahlung

Tabelle 2: Gefahrensymbole

### 1.2.3 Struktur der Warnhinweise

Warnhinweise haben in diesem Dokument ein einheitliches Aussehen und eine einheitliche Struktur.



	<div style="background-color: red; color: white; padding: 2px; text-align: center;"><b>⚠ GEFAHR</b></div> <p><b>Art und Quelle der Gefahr!</b> Mögliche Folgen bei Nichtbeachtung der Gefahr / des Warnhinweises.</p> <ul style="list-style-type: none"> <li>▶ Maßnahmen und Verbote zur Vermeidung der Gefahr.</li> </ul>
--	--

Das folgende Beispiel zeigt einen Warnhinweis, der vor Stromschlaggefahr durch spannungsführende Teile warnt. Die Maßnahme zur Vermeidung der Gefahr wird genannt.

	<div style="background-color: red; color: white; padding: 2px; text-align: center;"><b>⚠ GEFAHR</b></div> <p><b>Stromschlaggefahr durch spannungsführende Teile!</b> Tod durch Stromschlag</p> <ul style="list-style-type: none"> <li>▶ Gerät mindestens 60 Sekunden vor Reparaturbeginn vom Netz trennen.</li> </ul>
--	---

### 1.2.4 Allgemeine Symbole

In diesem Dokument werden folgende allgemeine Symbole verwendet:

Allg. Symbol	Bedeutung
	Kennzeichnung eines besonderen (Text und/oder Grafik) Tipps
	Kennzeichnung eines einfachen (nur Text) Tipps

Allg. Symbol	Bedeutung
	Kennzeichnung eines Links zu einer Videoanleitung
	Kennzeichnung erforderlicher Werkzeuge
	Kennzeichnung erforderlicher Voraussetzungen
	Kennzeichnung einer Bedingung (Wenn ..., dann ...)
	Kennzeichnung eines Ergebnisses
[Start]	Kennzeichnung einer Taste oder Schaltfläche
[00123456]	Kennzeichnung einer Materialnummer
Status	Kennzeichnung eines angezeigten Textes / Fensters (im Gerätedisplay)

Tabelle 3: Allgemeine Symbole

## 2.1 Allgemeine Sicherheitshinweise

### 2.1.1 Alle Hausgeräte

#### **Stromschlaggefahr durch spannungsführende Teile!**

- Wenn elektrische Komponenten fehlerhaft repariert werden, besteht Stromschlaggefahr!
- Das Gerät mindestens 60 Sekunden vor Beginn der Arbeiten vom Netz trennen.
- Nach der Reparatur muss eine Sicherheitsprüfung nach VDE 0701 oder länderspezifischen Vorschriften durchgeführt werden.

#### **Verletzungsgefahr durch scharfe Kanten!**

- Schutzhandschuhe tragen.

#### **Quetschgefahr während Reparatur-, Wartungs-, Fehlersuche- und Servicearbeiten durch schwere sich bewegende Bauteile**

- Schutzhandschuhe tragen.
- Schwere Bauteile gegen Herabfallen sichern.
- Körperteile nicht in sich bewegende Bauteile stecken.







#### **Gefährdung der Gerätesicherheit/-funktion!**





- Ausschließlich Originalersatzteile verwenden.

#### **Gefahr der Beschädigung elektrostatisch gefährdeter Bauteile (elektrostatische Entladungen)!**

- Die Module, einschließlich ihrer Anschlüsse und Leiterbahnen, keinesfalls berühren.

## Werkzeuge und Hilfsmittel

Bezeichnung	Details	Bilder
Hilfswerkzeug [15000155]	Montagekeil zum Ausrasten von Plastikteilen	
Schraubendreher Torx T20 mit Boh- rung [00340764]	100 mm, für Schrauben mit Si- cherheitsstift	
Drehmoment- Schlüssel [15000441]	Drehmoment-Schlüssel 20 - 100 Nm	
Schlitzschrauben- dreher [00340854]	Klinge 3,5 mm x 0,6 mm x 100 mm, Schutzisolation 1000 V Wechselstrom	
Schlitzschrauben- dreher [00340855]	Klinge 5,5 mm x 1,0 mm x 125 mm, Schutzisolation 1000 V Wechselstrom	
Spitzzange, gebo- gen [00341269]	Länge 200 mm	
Seitenschneider [00342182]	Länge: 200 mm	



Bezeichnung	Details	Bilder
Gabel-Ringschlüs- sel [00340811]	Schlüsselweite 10°mm, M6	
Combination wrench [00340814]	Schlüsselweite 13°mm, M8	
Gabel-Ringschlüs- sel [00340817]	Schlüsselweite 17 mm, M10	
Gabel-Ringschlüs- sel [15000459]	Schlüsselweite 16°mm, M10	

## 4.1 Arbeitsplatte tauschen

### Spezielle Hilfsmittel:

-  Torx-Bit TX20 mit Bohrung Länge 152 mm, nutzbare Länge 124 mm, 1/4" Sechskantantrieb (6,35 mm), für Schrauben mit Sicherheitsstift [00341272]

### Voraussetzung:

-  Das Gerät ist spannungsfrei.
-  Das Gerät ist von der Wasserversorgung getrennt.

### 4.1.1 Arbeitsplatte demontieren

- ▶ 1. Schrauben entfernen (1).
- ▶ 2. Die Arbeitsplatte bis zur Geräterückseite schieben (2).
- ▶ 3. Die Arbeitsplatte nach oben (3) abnehmen.

### 4.1.2 Arbeitsplatte montieren



Auf eine ordnungsgemäße Kabelverlegung achten. Ein Einklemmen des Kabels muss unbedingt vermieden werden.

- ▶ Der Einbau erfolgt in umgekehrter Reihenfolge.

## 4.2 Austauschen der Waschmittelschublade

### Voraussetzung:

- ✓ Das Gerät ist spannungsfrei.
- ✓ Das Gerät ist von der Wasserversorgung getrennt.

### 4.2.1 Ausbauen der Waschmittelschublade

1. Die Waschmittelschublade herausziehen.
2. 1. Druck auf den Einsatz ausüben (1).  
2. Die Waschmittelschublade entfernen (2).

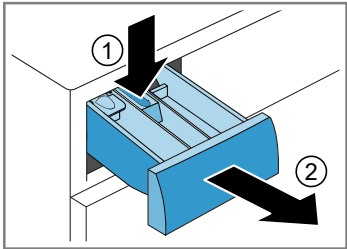

### 4.2.2 Einbauen der Waschmittelschublade

- ▶ Der Einbau erfolgt in umgekehrter Reihenfolge.

## 4.3 Austauschen des Griffs der Waschmittelschublade

### Voraussetzung:

- ✓ Das Gerät ist spannungsfrei.
- ✓ Das Gerät ist von der Wasserversorgung getrennt.
- ✓ [Die Waschmittelschublade ist entfernt worden. → Seite 180](#)

### 4.3.1 Ausbauen des Griffs der Waschmittelschublade

1. Die Rastelemente lösen.

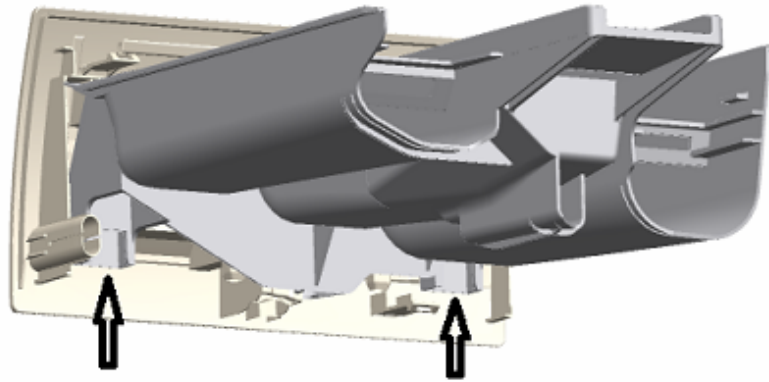

2. Den Griff der Waschmittelschublade entfernen.

### 4.3.2 Einbauen des Griffs der Waschmittelschublade

- ▶ Der Einbau erfolgt in umgekehrter Reihenfolge.

## 4.4 Austauschen der Bedienblende

Als Hersteller sind wir nach der Verordnung (EU) 2019/2023 verpflichtet, Verbrauchern die Bedienblende einschließlich Reparaturanleitung als Ersatzteil zur Verfügung zu stellen. Wir möchten jedoch darauf hinweisen, dass nach dem Austausch der Bedienblende eine elektrotechnische Sicherheitsprüfung durch eine Elektrofachkraft erforderlich ist, bevor das Gerät in Betrieb genommen wird. Diese Person muss nachweislich gemäß den länderspezifischen Gesetzen, Vorschriften und Normen qualifiziert sein.

	<p style="text-align: center;"><b>⚠️ GEFAHR</b></p> <p><b>Stromschlaggefahr durch spannungsführende Teile!</b>          Lebensgefahr durch Stromschlag bei unsachgemäßer Reparatur</p> <ul style="list-style-type: none"> <li>▶ Elektroteile sollten von einer Elektrofachkraft repariert werden.</li> <li>▶ Nach der Reparatur muss eine Sicherheitsprüfung nach VDE 0701 oder länderspezifischen Vorschriften durchgeführt werden.</li> </ul>
	<p style="text-align: center;"><b>⚠️ WARNUNG</b></p> <p><b>Wegrutschen des gekippten Gerätes!</b>          Knochenbrüche / Quetschungen</p> <ul style="list-style-type: none"> <li>▶ Gerät gegen Wegrutschen sichern.</li> </ul>
	<p style="text-align: center;"><b>⚠️ VORSICHT</b></p> <p><b>Scharfe Gehäusekanten!</b>          Schnittverletzungen</p> <ul style="list-style-type: none"> <li>▶ Schutzhandschuhe tragen.</li> </ul>
	<p style="text-align: center;"><b>⚠️ VORSICHT</b></p> <p><b>Risiko herabfallender Teile durch gelöste Schrauben!</b>          Verletzungsgefahr durch herabfallende Teile.</p> <ul style="list-style-type: none"> <li>▶ Die Komponenten gegen Herunterfallen sichern.</li> </ul>
	<p style="text-align: center;"><b>⚠️ ACHTUNG</b></p> <p><b>Risiko herabfallender Teile durch gelöste Schrauben!</b>          Gefahr der Beschädigung anderer Geräteteile bzw. von Beschädigungen im Haushalt des Kunden, z. B. des Bodens.</p> <ul style="list-style-type: none"> <li>▶ Die Komponenten gegen Herunterfallen sichern.</li> </ul>

### Voraussetzung:

- ✔ Das Gerät ist spannungsfrei.

- ✔ Das Gerät ist von der Wasserversorgung getrennt.
- ✔ [Die Arbeitsplatte ist entfernt worden.→ Seite 179](#)
- ✔ [Die Waschmittelschublade ist entfernt worden.→ Seite 180](#)

### 4.4.1 Ausbauen der Bedienblende

1. 1. Schrauben entfernen (1).
2. Die Rastelemente lösen (2, 3).

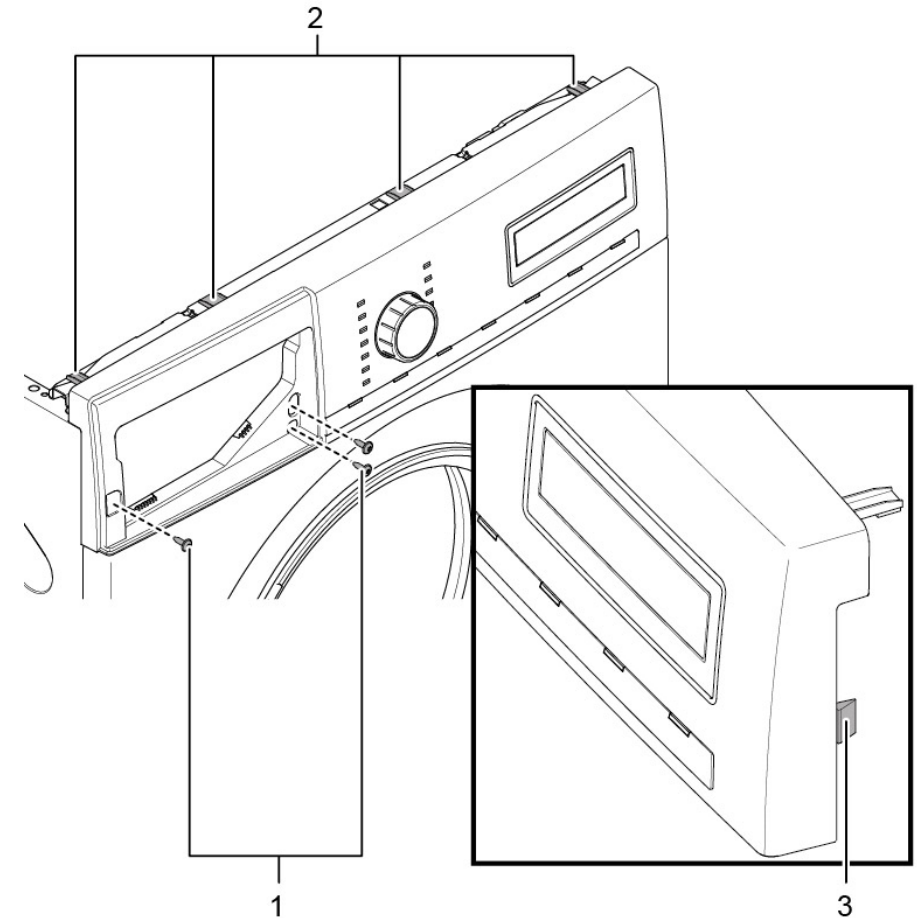

2. Den Steckkontakt der Steuereinheit lösen.
3. Die Bedienblende entfernen.

## 4.4.2 Einbauen der Bedienblende





Auf eine ordnungsgemäße Kabelverlegung achten. Ein Einklemmen des Kabels muss unbedingt vermieden werden.

- ▶ Der Einbau erfolgt in umgekehrter Reihenfolge.

## 4.5 Tür austauschen

	<b>VORSICHT</b> <b>Offener Scharnierbereich!</b> Quetschen / Einklemmen der Finger ▶ Nicht in den Scharnierbereich greifen. ▶ Schutzhandschuhe tragen.
--	--

	<b>VORSICHT</b> <b>Risiko herabfallender Teile durch gelöste Schrauben!</b> Verletzungsgefahr durch herabfallende Teile. ▶ Die Komponenten gegen Herunterfallen sichern.
--	---

	<b>ACHTUNG</b> <b>Risiko herabfallender Teile durch gelöste Schrauben!</b> Gefahr der Beschädigung anderer Geräteteile bzw. von Beschädigungen im Haushalt des Kunden, z. B. des Bodens. ▶ Die Komponenten gegen Herunterfallen sichern.
--	---

### Voraussetzung:

- ✔ Das Gerät ist spannungsfrei.
- ✔ Das Gerät ist von der Wasserversorgung getrennt.
- ✔ Die Tür ist geöffnet.

### 4.5.1 Ausbauen der Tür

1. Die Schrauben entfernen (1).

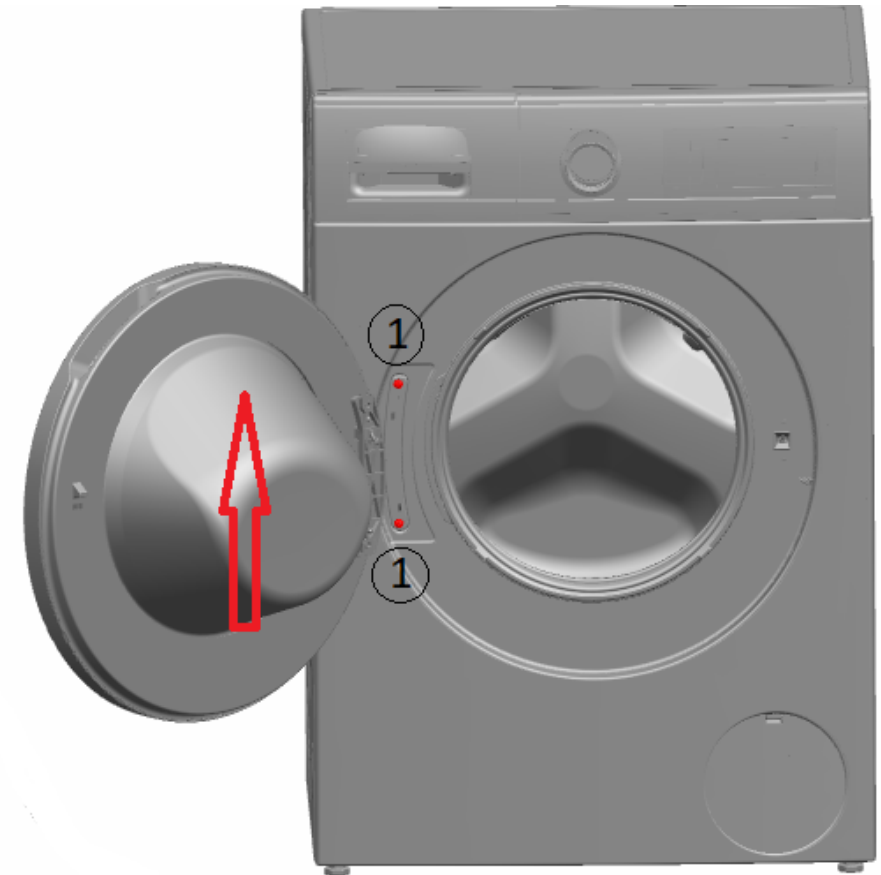



2. Die Tür nach oben abnehmen.

### 4.5.2 Einbauen der Tür

- ▶ Der Einbau erfolgt in umgekehrter Reihenfolge.

## 4.6 Austauschen der Türkomponenten

	<b>⚠️ WARNUNG</b>
	<b>Schwere und sich bewegende Bauteile!</b> Quetschgefahr während Reparatur-, Wartungs-, Fehlersuche- und Servicearbeiten <ul style="list-style-type: none"><li>▶ Schutzhandschuhe tragen.</li><li>▶ Schwere Bauteile gegen Herabfallen sichern.</li><li>▶ Körperteile nicht in sich bewegende Bauteile stecken.</li></ul>

	<b>⚠️ VORSICHT</b>
	<b>Offener Scharnierbereich!</b> Quetschen / Einklemmen der Finger <ul style="list-style-type: none"><li>▶ Nicht in den Scharnierbereich greifen.</li><li>▶ Schutzhandschuhe tragen.</li></ul>

### Voraussetzung:

- ✔ Das Gerät ist spannungsfrei.
- ✔ Das Gerät ist von der Wasserversorgung getrennt.
- ✔ Tür ist ausgebaut. → [Seite 184](#)

### 4.6.1 Ausbauen der Türkomponenten

- ▶ Die Tür von außen nach innen demontieren.

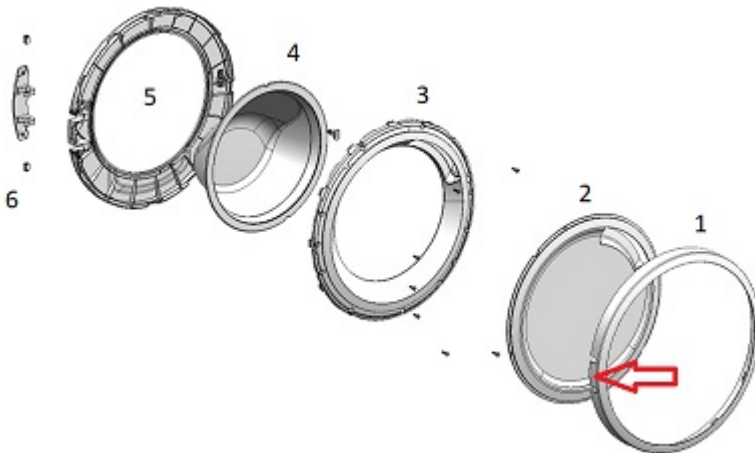

### 4.6.2 Einbauen der Türkomponenten

- ▶ Der Einbau erfolgt in umgekehrter Reihenfolge.

## 4.7 Austauschen der Pumpenabdeckung

### Voraussetzung:

- ✓ Das Gerät ist spannungsfrei.
- ✓ Das Gerät ist von der Wasserversorgung getrennt.

### 4.7.1 Ausbauen der Pumpenabdeckung

1. Die Pumpenabdeckung öffnen.

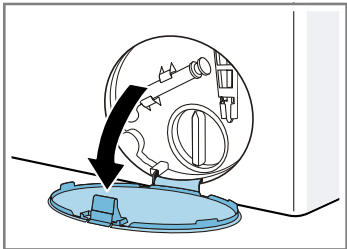

2. Die Pumpenabdeckung entfernen.

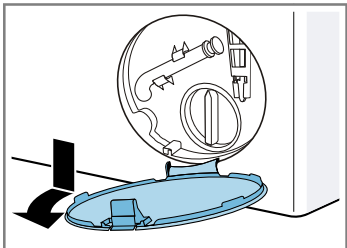



### 4.7.2 Einbauen der Pumpenabdeckung

- ▶ Der Einbau erfolgt in umgekehrter Reihenfolge.

## 4.8 Austauschen der Türdichtung

	<b>VORSICHT</b> <b>Scharfe Gehäusekanten!</b> Schnittverletzungen ▶ Schutzhandschuhe tragen.
--	---

	<b>VORSICHT</b> <b>Risiko herabfallender Teile durch gelöste Schrauben!</b> Verletzungsgefahr durch herabfallende Teile. ▶ Die Komponenten gegen Herunterfallen sichern.
--	---

	<b>ACHTUNG</b> <b>Risiko herabfallender Teile durch gelöste Schrauben!</b> Gefahr der Beschädigung anderer Geräteteile bzw. von Beschädigungen im Haushalt des Kunden, z. B. des Bodens. ▶ Die Komponenten gegen Herunterfallen sichern.
--	---

### Voraussetzung:

- ✔ Das Gerät ist spannungsfrei.
- ✔ Das Gerät ist von der Wasserversorgung getrennt.
- ✔ Das Gerät ist frei zugänglich.
- ✔ [Die Arbeitsplatte ist entfernt worden.→ Seite 179](#)
- ✔ [Die Waschmittelschublade ist entfernt worden.→ Seite 180](#)
- ✔ [Die Bedienblende ist entfernt worden.→ Seite 182](#)
- ✔ [Tür ist ausgebaut.→ Seite 184](#)
- ✔ [Die Pumpenabdeckung ist entfernt worden.→ Seite 186](#)
- ✔ [Die Frontblende ist entfernt worden.→ Seite 192](#)
- ✔ [Die Trommelbeleuchtung ist entfernt worden \(optional\).→ Seite 191](#)

## 4.8.1 Ausbauen der Türdichtung

1. Alle Schlauchanschlüsse lösen.

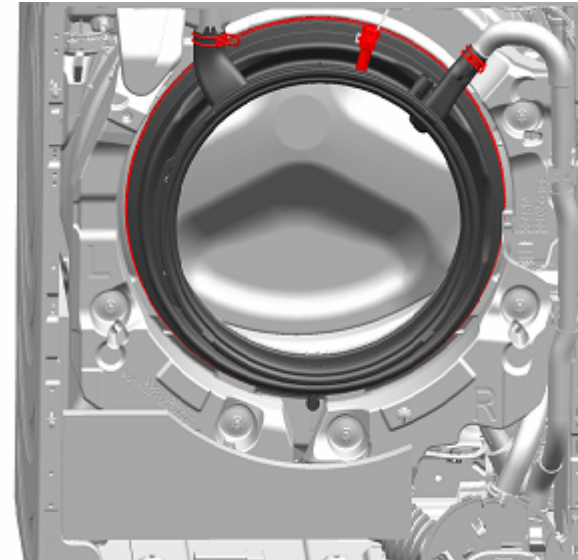

2. Die Türdichtung entfernen.

## 4.8.2 Einbauen der Türdichtung

	<b>WARNUNG</b> <b>Gefahr durch herabfallende Gegenstände aufgrund unsachgemäßer Montage!</b> Verletzung oder Gerätebeschädigung. ▶ Spanning der Muffendichtung mit 3,4 Nm anziehen.
--	--

- ▶ Der Einbau erfolgt in umgekehrter Reihenfolge.

## 4.9 Austauschen der Türverriegelung

Als Hersteller sind wir nach der Verordnung (EU) 2019/2023 verpflichtet, Verbrauchern die Türsicherung einschließlich Reparaturanleitung als Ersatzteil zur Verfügung zu stellen. Wir möchten jedoch darauf hinweisen, dass nach dem Austausch der Türsicherung eine elektrotechnische Sicherheitsprüfung durch eine Elektrofachkraft erforderlich ist, bevor das Gerät in Betrieb genommen wird. Diese Person muss nachweislich gemäß den länderspezifischen Gesetzen, Vorschriften und Normen qualifiziert sein.

	<b>⚠ GEFAHR</b>
	<p><b>Stromschlaggefahr durch spannungsführende Teile!</b>                  Lebensgefahr durch Stromschlag bei unsachgemäßer Reparatur</p> <ul style="list-style-type: none"> <li>▶ Elektroteile sollten von einer Elektrofachkraft repariert werden.</li> <li>▶ Nach der Reparatur muss eine Sicherheitsprüfung nach VDE 0701 oder länderspezifischen Vorschriften durchgeführt werden.</li> </ul>

	<b>⚠ WARNUNG</b>
	<p><b>Wegrutschen des gekippten Gerätes!</b>                  Knochenbrüche / Quetschungen</p> <ul style="list-style-type: none"> <li>▶ Gerät gegen Wegrutschen sichern.</li> </ul>

	<b>⚠ VORSICHT</b>
	<p><b>Scharfe Gehäusekanten!</b>                  Schnittverletzungen</p> <ul style="list-style-type: none"> <li>▶ Schutzhandschuhe tragen.</li> </ul>

	<b>⚠ VORSICHT</b>
	<p><b>Risiko herabfallender Teile durch gelöste Schrauben!</b>                  Verletzungsgefahr durch herabfallende Teile.</p> <ul style="list-style-type: none"> <li>▶ Die Komponenten gegen Herunterfallen sichern.</li> </ul>

	<b>ACHTUNG</b>
	<p><b>Risiko herabfallender Teile durch gelöste Schrauben!</b>                  Gefahr der Beschädigung anderer Geräteteile bzw. von Beschädigungen im Haushalt des Kunden, z. B. des Bodens.</p> <ul style="list-style-type: none"> <li>▶ Die Komponenten gegen Herunterfallen sichern.</li> </ul>

### Voraussetzung:

- ✓ Das Gerät ist spannungsfrei.

- ✓ Das Gerät ist von der Wasserversorgung getrennt.
- ✓ Das Gerät ist frei zugänglich.
- ✓ [Die Arbeitsplatte ist entfernt worden.→ Seite 179](#)
- ✓ [Die Waschmittelschublade ist entfernt worden.→ Seite 180](#)
- ✓ [Die Bedienblende ist entfernt worden.→ Seite 182](#)
- ✓ [Tür ist ausgebaut.→ Seite 184](#)
- ✓ Der Spannung ist entfernt worden.
- ✓ [Die Türdichtung ist entfernt worden.→ Seite 187](#)
- ✓ [Die Pumpenabdeckung ist entfernt worden.→ Seite 186](#)
- ✓ [Die Frontblende ist entfernt worden.→ Seite 192](#)

### 4.9.1 Türverriegelung demontieren

1. Den Stecker der Türverriegelung abziehen.
2. Die Türverriegelung lösen.



3. Die Türverriegelung entfernen.

### 4.9.2 Türverriegelung montieren

Die Türverriegelung muss sich in der richtigen Position befinden, um die ordnungsgemäße Notfall-Türöffnungsfunktion des Geräts sicherzustellen.

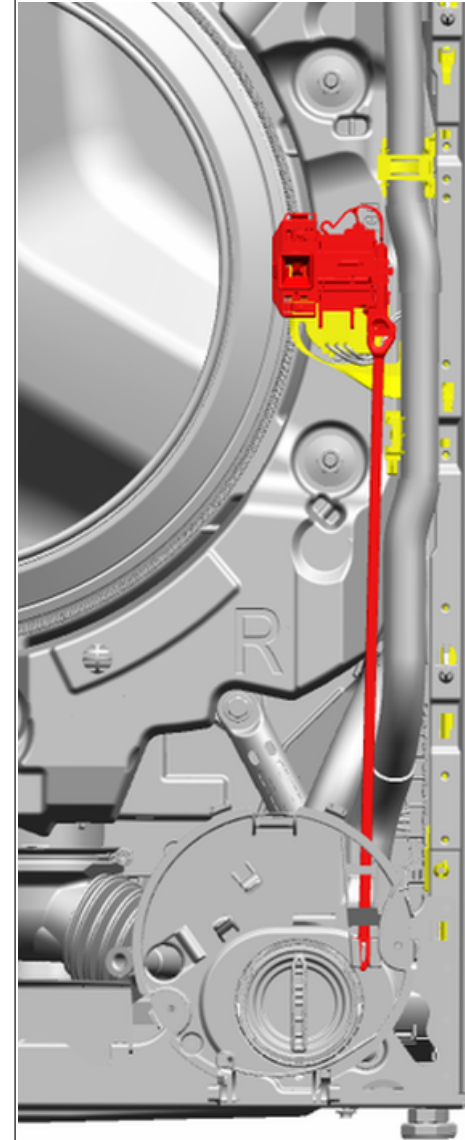

## Instandsetzen

- ▶ Der Einbau erfolgt in umgekehrter Reihenfolge.

## 4.10 Austauschen der Trommelbeleuchtung

	<p style="text-align: center;"><b>⚠️ WARNUNG</b></p> <p><b>Wegrutschen des gekippten Gerätes!</b> Knochenbrüche / Quetschungen</p> <ul style="list-style-type: none"> <li>▶ Gerät gegen Wegrutschen sichern.</li> </ul>
	<p style="text-align: center;"><b>⚠️ VORSICHT</b></p> <p><b>Scharfe Gehäusekanten!</b> Schnittverletzungen</p> <ul style="list-style-type: none"> <li>▶ Schutzhandschuhe tragen.</li> </ul>
	<p style="text-align: center;"><b>⚠️ VORSICHT</b></p> <p><b>Risiko herabfallender Teile durch gelöste Schrauben!</b> Verletzungsgefahr durch herabfallende Teile.</p> <ul style="list-style-type: none"> <li>▶ Die Komponenten gegen Herunterfallen sichern.</li> </ul>
	<p style="text-align: center;"><b>⚠️ ACHTUNG</b></p> <p><b>Risiko herabfallender Teile durch gelöste Schrauben!</b> Gefahr der Beschädigung anderer Geräteteile bzw. von Beschädigungen im Haushalt des Kunden, z. B. des Bodens.</p> <ul style="list-style-type: none"> <li>▶ Die Komponenten gegen Herunterfallen sichern.</li> </ul>

### Voraussetzung:

- ✔ Das Gerät ist spannungsfrei.
- ✔ Das Gerät ist von der Wasserversorgung getrennt.
- ✔ Das Gerät ist frei zugänglich.
- ✔ [Die Arbeitsplatte ist entfernt worden. → Seite 179](#)
- ✔ [Die Waschmittelschublade ist entfernt worden. → Seite 180](#)
- ✔ [Die Bedienblende ist entfernt worden. → Seite 182](#)

### 4.10.1 Ausbauen der Trommelbeleuchtung

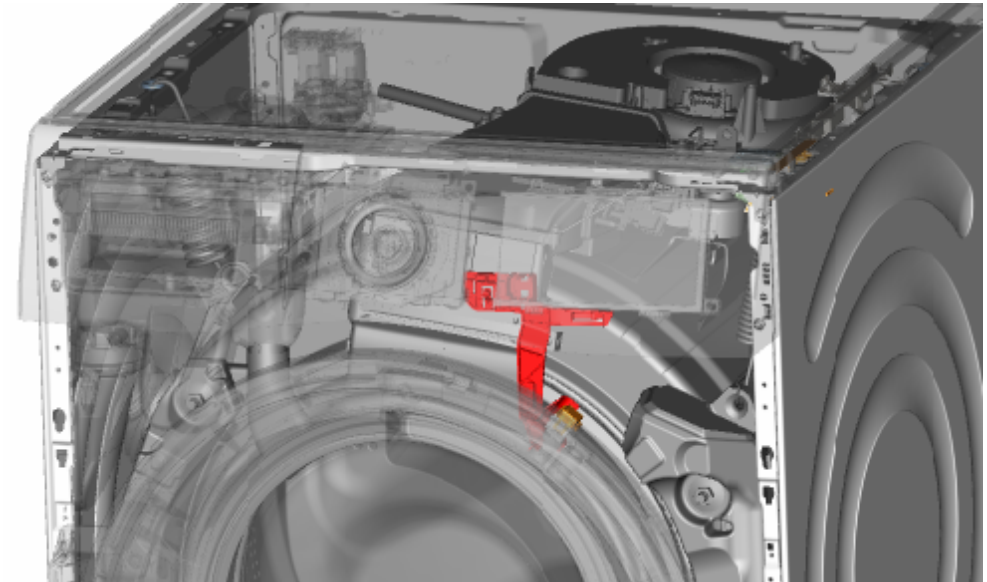





1. Die Trommelbeleuchtungshalterung aus dem Gerät ziehen.
2. Die elektrischen Anschlüsse trennen.
3. Die Trommelbeleuchtung aus der Trommelbeleuchtungshalterung entfernen.

### 4.10.2 Einbauen der Trommelbeleuchtung

	<p>Auf eine ordnungsgemäße Kabelverlegung achten. Ein Einklemmen des Kabels muss unbedingt vermieden werden.</p>
---	--

- ▶ Der Einbau erfolgt in umgekehrter Reihenfolge.

## 4.11 Austauschen der Frontblende

	<p style="text-align: center;"><b>⚠️ WARNUNG</b></p> <p><b>Wegrutschen des gekippten Gerätes!</b> Knochenbrüche / Quetschungen</p> <ul style="list-style-type: none"> <li>▶ Gerät gegen Wegrutschen sichern.</li> </ul>
	<p style="text-align: center;"><b>⚠️ VORSICHT</b></p> <p><b>Scharfe Gehäusekanten!</b> Schnittverletzungen</p> <ul style="list-style-type: none"> <li>▶ Schutzhandschuhe tragen.</li> </ul>
	<p style="text-align: center;"><b>⚠️ VORSICHT</b></p> <p><b>Risiko herabfallender Teile durch gelöste Schrauben!</b> Verletzungsgefahr durch herabfallende Teile.</p> <ul style="list-style-type: none"> <li>▶ Die Komponenten gegen Herunterfallen sichern.</li> </ul>
	<p style="text-align: center;"><b>⚠️ ACHTUNG</b></p> <p><b>Risiko herabfallender Teile durch gelöste Schrauben!</b> Gefahr der Beschädigung anderer Geräteteile bzw. von Beschädigungen im Haushalt des Kunden, z. B. des Bodens.</p> <ul style="list-style-type: none"> <li>▶ Die Komponenten gegen Herunterfallen sichern.</li> </ul>

### Voraussetzung:

- ✔ Das Gerät ist spannungsfrei.
- ✔ Das Gerät ist von der Wasserversorgung getrennt.
- ✔ Das Gerät ist frei zugänglich.
- ✔ [Die Arbeitsplatte ist entfernt worden.→ Seite 179](#)
- ✔ [Die Waschmittelschublade ist entfernt worden.→ Seite 180](#)
- ✔ [Die Bedienblende ist entfernt worden.→ Seite 182](#)
- ✔ [Tür ist ausgebaut.→ Seite 184](#)
- ✔ [Die Pumpenabdeckung ist entfernt worden.→ Seite 186](#)
- ✔ Der Spannring ist entfernt worden.
- ✔ Die Türdichtung an der Vorderseite ist gelöst worden.
- ✔ [Die Trommelbeleuchtung ist entfernt worden \(optional\).→ Seite 191](#)

### 4.11.1 Ausbauen der Frontblende

1. Das Gerät an der Vorderseite anheben.
2. Die Schrauben an der Unterseite entfernen (1).

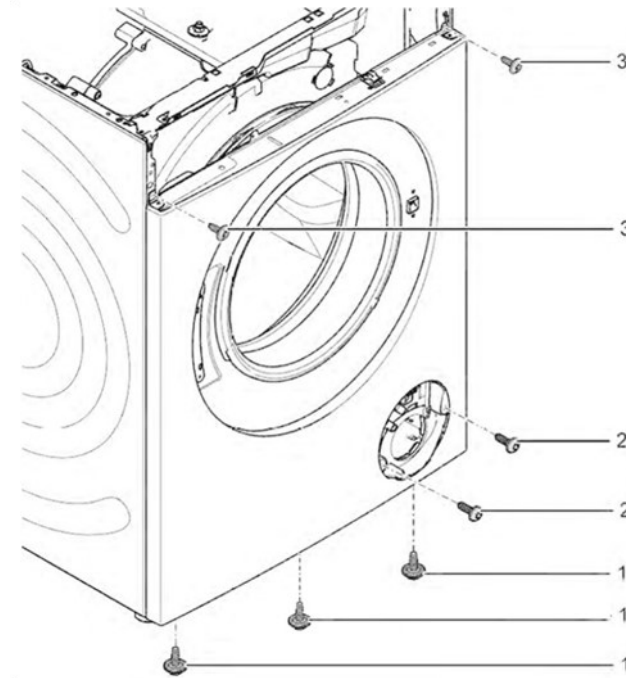

3. Das Gerät wieder auf dem Boden abstellen.

4. Die Schrauben an der Vorderseite von unten beginnend entfernen (2, 3).

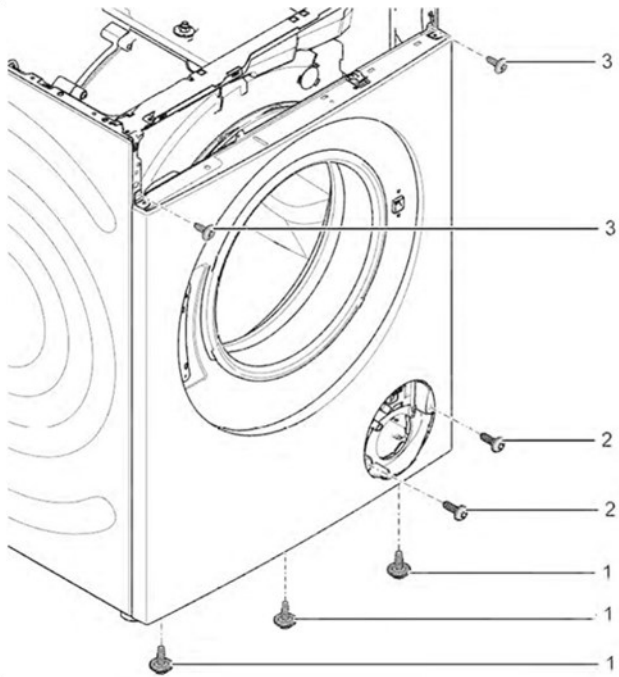





5. Die Frontblende entfernen.

### 4.11.2 Einbauen der Frontblende

- ▶ Der Einbau erfolgt in umgekehrter Reihenfolge.

# Υποδείξεις επισκευής - Πλυντήριο ρούχων

 <b>Σχετικά με αυτό το έγγραφο</b> .....	<b>195</b>
1.1 Σημαντικές πληροφορίες.....	195
1.1.1 Σκοπός.....	195
1.2 Επεξήγηση συμβόλων.....	195
1.2.1 Επίπεδα κινδύνου.....	195
1.2.2 Σύμβολα κινδύνου.....	195
1.2.3 Δομή των προειδοποιήσεων.....	196
1.2.4 Γενικά σύμβολα.....	196
 <b>Ασφάλεια</b> .....	<b>197</b>
2.1 Γενικές οδηγίες ασφαλείας.....	197
2.1.1 Όλες οι οικιακές συσκευές.....	197
 <b>Εργαλεία και βοηθήματα</b> .....	<b>198</b>
 <b>Επισκευή</b> .....	<b>199</b>
4.1 Αντικατάσταση καπακιού εργασίας.....	199
4.1.1 Αφαίρεση καπακιού εργασίας.....	199
4.1.2 Τοποθέτηση καπακιού εργασίας.....	199
4.2 Αντικατάσταση συρταριού απορρυπαντικού.....	200
4.2.1 Αφαίρεση συρταριού απορρυπαντικού.....	200
4.2.2 Τοποθέτηση συρταριού απορρυπαντικού.....	200
4.3 Αντικατάσταση λαβής συρταριού απορρυπαντικού.....	201
4.3.1 Αφαίρεση λαβής συρταριού απορρυπαντικού.....	201
4.3.2 Τοποθέτηση λαβής συρταριού απορρυπαντικού.....	201
4.4 Αντικατάσταση μετώπης.....	202
4.4.1 Αφαίρεση μετώπης.....	202
4.4.2 Τοποθέτηση μετώπης.....	203
4.5 Αντικατάσταση πόρτας.....	204
4.5.1 Αφαίρεση πόρτας.....	204
4.5.2 Τοποθέτηση πόρτας.....	204
4.6 Αντικατάσταση εξαρτημάτων πόρτας.....	205
4.6.1 Αφαίρεση εξαρτημάτων πόρτας.....	205
4.6.2 Τοποθέτηση εξαρτημάτων πόρτας.....	205
4.7 Αντικατάσταση καλύμματος αντλίας.....	206
4.7.1 Αφαίρεση καλύμματος αντλίας.....	206
4.7.2 Τοποθέτηση καλύμματος αντλίας.....	206

4.8 Αντικατάσταση στεγανοποιητικού πόρτας.....	207
4.8.1 Αφαίρεση στεγανοποιητικού πόρτας.....	207
4.8.2 Τοποθέτηση στεγανοποιητικού πόρτας.....	207
4.9 Αντικατάσταση ασφάλειας πόρτας.....	208
4.9.1 Αφαίρεση ασφάλειας πόρτας.....	208
4.9.2 Τοποθέτηση ασφάλειας πόρτας.....	209
4.10 Αντικατάσταση φωτισμού τυμπάνου.....	211
4.10.1 Αφαίρεση φωτισμού τυμπάνου.....	211
4.10.2 Τοποθέτηση φωτισμού τυμπάνου.....	211
4.11 Αντικατάσταση μπροστινού πίνακα.....	212
4.11.1 Αφαίρεση μπροστινού πίνακα.....	212
4.11.2 Τοποθέτηση μπροστινής μετώπης.....	213

# **i** Σχετικά με αυτό το έγγραφο

## 1.1 Σημαντικές πληροφορίες

### 1.1.1 Σκοπός

Αυτές οι συμβουλές επισκευών υποστηρίζουν τους καταναλωτές στην επισκευή των συσκευών από τους ίδιους, σύμφωνα με τον ισχύοντα κανονισμό οικολογικού σχεδιασμού (από τις 03/2021).





Περιέχουν πληροφορίες για την αντικατάσταση ορισμένων ανταλλακτικών, συμπεριλαμβανομένων προειδοποιήσεων και κινδύνων.

Σε περίπτωση ερωτήσεων, επικοινωνήστε με το τμήμα εξυπηρέτησης πελατών της εταιρείας μας. Φέρουμε ευθύνη για τις ζημιές εάν οι συμβουλές επισκευής έχουν ακολουθηθεί σωστά.

## 1.2 Επεξήγηση συμβόλων

### 1.2.1 Επίπεδα κινδύνου

Τα επίπεδα προειδοποίησης ασφάλειας αποτελούνται από ένα σύμβολο και μια λέξη. Η λέξη προειδοποίησης προσδιορίζει τη σοβαρότητα του κινδύνου.





Επίπεδο προειδοποίησης	Σημασία
 <b>ΚΙΝΔΥΝΟΣ</b>	Η μη τήρηση του προειδοποιητικού μηνύματος θα οδηγήσει σε θάνατο ή σε σοβαρούς τραυματισμούς.
 <b>ΠΡΟΕΙΔΟΠΟΙΗΣΗ</b>	Η μη τήρηση του προειδοποιητικού μηνύματος θα μπορούσε να οδηγήσει σε θάνατο ή σε σοβαρούς τραυματισμούς.
 <b>ΠΡΟΣΟΧΗ</b>	Η μη τήρηση του προειδοποιητικού μηνύματος θα μπορούσε να οδηγήσει σε μικρούς τραυματισμούς.
 <b>ΠΡΟΣΟΧΗ!</b>	Η μη τήρηση του προειδοποιητικού μηνύματος θα μπορούσε να οδηγήσει σε υλικές ζημιές της ιδιοκτησίας.

Πίνακας 1: Επίπεδα κινδύνου





### 1.2.2 Σύμβολα κινδύνου

Τα σύμβολα κινδύνου είναι συμβολικές αναπαραστάσεις που δίνουν μια ένδειξη για το είδος του κινδύνου.

Τα ακόλουθα σύμβολα κινδύνου χρησιμοποιούνται στο παρόν έγγραφο:

Σύμβολο κινδύνου	Σημασία
	Γενικό προειδοποιητικό μήνυμα
	Κίνδυνος από ηλεκτρική τάση
	Κίνδυνος έκρηξης
	Κίνδυνος κοψίματος

## **i** Σχετικά με αυτό το έγγραφο

Σύμβολο κινδύνου	Σημασία
	Κίνδυνος σύνθλιψης
	Κίνδυνος από καυτές επιφάνειες
	Κίνδυνος από ισχυρό μαγνητικό πεδίο
	Κίνδυνος από μη ιονίζουσα ακτινοβολία

Πίνακας 2: Σύμβολα κινδύνου

### 1.2.3 Δομή των προειδοποιήσεων

.Οι προειδοποιήσεις σε αυτό το έγγραφο έχουν μια τυποποιημένη εμφάνιση και μια τυποποιημένη δομή.









	<div style="background-color: red; color: white; padding: 2px; text-align: center;"><b>⚠ ΚΙΝΔΥΝΟΣ</b></div> <p><b>Είδος και πηγή κινδύνου!</b> Πιθανές συνέπειες εάν αγνοήσετε τον κίνδυνο/την προειδοποίηση. ▶ Μέτρα και απαγορεύσεις για την πρόληψη του κινδύνου.</p>
--	--

Το παρακάτω παράδειγμα δείχνει μια προειδοποίηση που προειδοποιεί κατά της ηλεκτροπληξίας λόγω ηλεκτροφόρων μερών. Αναφέρεται το μέτρο για την αποφυγή του κινδύνου.

	<div style="background-color: red; color: white; padding: 2px; text-align: center;"><b>⚠ ΚΙΝΔΥΝΟΣ</b></div> <p><b>Κίνδυνος ηλεκτροπληξίας λόγω ηλεκτροφόρων μερών!</b> Θάνατος από ηλεκτροπληξία ▶ Αποσυνδέετε τις συσκευές από την παροχή ηλεκτρικού ρεύματος τουλάχιστον 60 δευτερόλεπτα πριν ξεκινήσετε τις επισκευές.</p>
--	---

### 1.2.4 Γενικά σύμβολα

Τα ακόλουθα γενικά σύμβολα χρησιμοποιούνται στο παρόν έγγραφο:

Γεν. σύμβολο	Σημασία
	Ταυτοποίηση μιας ειδικής συμβουλής (κειμένου ή/και γραφικών)
	Ταυτοποίηση μιας ειδικής συμβουλής (μόνο κειμένου)
	Ταυτοποίηση συνδέσμου ή εκπαιδευτικού βίντεο
	Ταυτοποίηση απαραίτητων εργαλείων
	Ταυτοποίηση απαραίτητων προϋποθέσεων
	Ταυτοποίηση μιας συνθήκης (αν ..., κατόπιν ...)
	Ταυτοποίηση αποτελέσματος
	Ταυτοποίηση ενός πλήκτρου ή κουμπιού
[00123456]	Ταυτοποίηση ενός κωδικού ανταλλακτικού
Κατάσταση	Ταυτοποίηση εμφανιζόμενου κειμένου/παραθύρου (στην οθόνη της συσκευής)

Πίνακας 3: Γενικά σύμβολα

## 2.1 Γενικές οδηγίες ασφαλείας

### 2.1.1 Όλες οι οικιακές συσκευές

#### **Κίνδυνος ηλεκτροπληξίας λόγω ηλεκτροφόρων μερών!**

- Τα σφάλματα από επισκευές σε ηλεκτρικά εξαρτήματα μπορεί να προκαλέσουν ηλεκτροπληξία!
- Αποσυνδέστε τη συσκευή από την πρίζα για τουλάχιστον 60 δευτερόλεπτα πριν από την έναρξη των εργασιών.
- Μετά την επισκευή πραγματοποιήστε έλεγχο ασφαλείας σύμφωνα με το VDE 0701 ή κανονισμούς της συγκεκριμένης χώρας.

#### **Κίνδυνος τραυματισμού από κοφτερές άκρες!**

- Φοράτε προστατευτικά γάντια.

#### **Κίνδυνος σύνθλιψης κατά την επισκευή, συντήρηση, αντιμετώπιση προβλημάτων και το σέρβις από βαριά και κινούμενα μέρη**

- Φοράτε προστατευτικά υποδήματα.
- Ασφαλίστε τα βαριά μέρη από πτώση.
- Μην προσαρτάτε μέρη του πλαισίου στα κινούμενα μέρη.







#### **Κίνδυνος για την ασφάλεια/τη λειτουργία της συσκευής!**

- Χρησιμοποιείτε μόνο γνήσια ανταλλακτικά.

#### **Κίνδυνος πρόκλησης βλάβης σε μέρη ευαίσθητα στον στατικό ηλεκτρισμό (ESDs)!**

- Μην αγγίζετε τις μονάδες, συμπεριλαμβανομένων των συνδέσεων και των αγωγών των πλακετών.

## Εργαλεία και βοηθήματα

Όνομασία	Λεπτομέριες	Εικόνες
Βοηθητικό εργαλείο [15000155]	Εργαλείο λυσίματος πλαστικών τμημάτων	
Κατσαβίδι Torx T20 με τρύπα [00340764]	100 mm, για βίδες με κοπίλια	
Ροπόκλειδο [15000441]	Ροπόκλειδο 20 - 100 Nm	
Πλακέ κατσαβίδι [00340854]	Λεπίδα 3,5 mm x 0,6 mm x 100 mm, Προστατευτική μόνωση 1000 V AC	
Πλακέ κατσαβίδι [00340855]	Λεπίδα 5,5 mm x 1,0 mm x 125 mm, Προστατευτική μόνωση 1000 V AC	
Μυτοσίμπιδο, γωνιαστό [00341269]	Μήκος 200 mm	
Κοφτάκι [00342182]	Μήκος: 200 mm	



Όνομασία	Λεπτομέριες	Εικόνες
Συνδυαστικό κλειδί (Γερμανοπολύγωνο) [00340811]	Νούμερο κλειδιού (Γερμανοπολύγωνο) 10°mm, M6	
Combination wrench [00340814]	Νούμερο κλειδιού (Γερμανοπολύγωνο) 13°mm, M8	
Συνδυαστικό κλειδί (Γερμανοπολύγωνο) [00340817]	Νούμερο κλειδιού (Γερμανοπολύγωνο) 17 mm, M10	
Συνδυαστικό κλειδί (Γερμανοπολύγωνο) [15000459]	Νούμερο κλειδιού (Γερμανοπολύγωνο) 16°mm, M10	

## 4.1 Αντικατάσταση καπακιού εργασίας

### Ειδικά βοηθητικά μέσα:

-  Μύτη Torx TX20 με τρύπα      Μήκος 152 mm, ωφέλιμο μήκος 124 mm, 1/4" εξαγωνικό καρέ (6,35 mm), για βίδες με πείρο ασφαλείας      [00341272]

### Προϋπόθεση:

-  Η συσκευή είναι αποσυνδεμένη από την παροχή τροφοδοσίας.
-  Η συσκευή είναι αποσυνδεμένη από την παροχή νερού.

### 4.1.1 Αφαίρεση καπακιού εργασίας

- ▶ 1. Αφαιρέστε τις βίδες (1).
- ▶ 2. Σπρώξτε το καπάκι εργασίας στην πίσω πλευρά της συσκευής (2).
- ▶ 3. Μετακινήστε το καπάκι εργασίας προς τα επάνω (3) για να το αφαιρέσετε.

### 4.1.2 Τοποθέτηση καπακιού εργασίας



Προσέξτε την εγκατάσταση των καλωδίων. Το καλώδιο θα μπορούσε να παγιδευτεί.

- ▶ Εγκαταστήστε με την αντίθετη σειρά.

## 4.2 Αντικατάσταση συρταριού απορρυπαντικού

### Προϋπόθεση:

- ✓ Η συσκευή είναι αποσυνδεδεμένη από την παροχή τροφοδοσίας.
- ✓ Η συσκευή είναι αποσυνδεδεμένη από την παροχή νερού.

### 4.2.1 Αφαίρεση συρταριού απορρυπαντικού

1. Τραβήξτε έξω το συρτάρι απορρυπαντικού.
2. 1. Πιέστε κάτω το ένθετο (1).  
2. Αφαιρέστε το συρτάρι απορρυπαντικού (2).

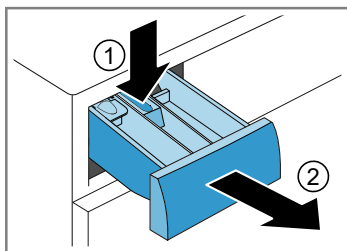

### 4.2.2 Τοποθέτηση συρταριού απορρυπαντικού

- ▶ Εγκαταστήστε με την αντίθετη σειρά.

## 4.3 Αντικατάσταση λαβής συρταριού απορρυπαντικού

### Προϋπόθεση:

- ✔ Η συσκευή είναι αποσυνδεδεμένη από την παροχή τροφοδοσίας.
- ✔ Η συσκευή είναι αποσυνδεδεμένη από την παροχή νερού.
- ✔ [Έχει αφαιρεθεί το συρτάρι απορρυπαντικού.→200](#)

### 4.3.1 Αφαίρεση λαβής συρταριού απορρυπαντικού

1. Απασφαλίστε τα στοιχεία συγκράτησης.

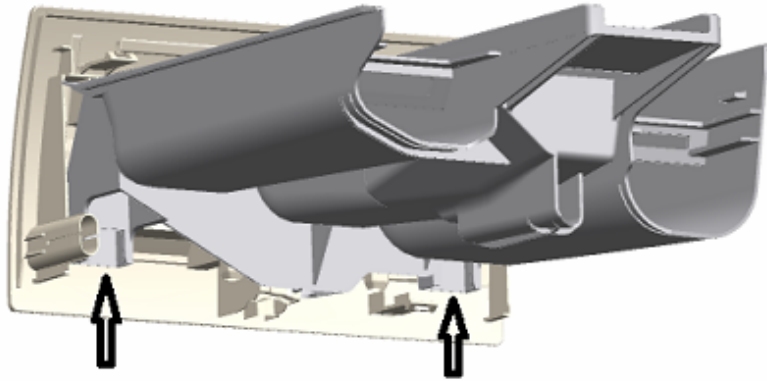

2. Αφαιρέστε τη λαβή συρταριού απορρυπαντικού.

### 4.3.2 Τοποθέτηση λαβής συρταριού απορρυπαντικού

- ▶ Εγκαταστήστε με την αντίθετη σειρά.

## 4.4 Αντικατάσταση μετώπης

Ως κατασκευαστής, υποχρεούμαστε να παρέχουμε στους πελάτες την ανταλλακτική μετώπη, συμπεριλαμβανομένων των οδηγιών επισκευής σύμφωνα με τον Κανονισμό (ΕΕ) 2019/2023. Ωστόσο, θα θέλαμε να επισημάνουμε ότι μετά την αντικατάσταση της μετώπης, απαιτείται ένας έλεγχος ηλεκτροτεχνικής ασφάλειας από εκπαιδευμένο ηλεκτρολόγο πριν τεθεί σε λειτουργία η συσκευή. Αυτό το άτομο πρέπει να είναι αποδεδειγμένα εκπαιδευμένο σύμφωνα με τους νόμους, τους κανονισμούς και τα πρότυπα της συγκεκριμένης χώρας.

	<b>⚠ ΚΙΝΔΥΝΟΣ</b>
	<p><b>Κίνδυνος ηλεκτροπληξίας λόγω ηλεκτροφόρων μερών!</b> Κίνδυνος για τη ζωή από ηλεκτροπληξία σε περίπτωση ακατάλληλης επισκευής</p> <ul style="list-style-type: none"> <li>▶ Τα ηλεκτρικά μέρη πρέπει να επισκευάζονται από εκπαιδευμένους ηλεκτρολόγους.</li> <li>▶ Μετά την επισκευή πραγματοποιήστε έλεγχο ασφάλειας σύμφωνα με το VDE 0701 ή κανονισμούς της συγκεκριμένης χώρας.</li> </ul>

	<b>⚠ ΠΡΟΕΙΔΟΠΟΙΗΣΗ</b>
	<p><b>Ολίσθηση κεκλιμένων συσκευών!</b> Κατάγματα οστών/τραυματισμοί σύνθλιψης</p> <ul style="list-style-type: none"> <li>▶ Ασφαλίστε τις συσκευές από ολίσθηση.</li> </ul>

	<b>⚠ ΠΡΟΣΟΧΗ</b>
	<p><b>Αιχμηρά άκρα περιβλήματος!</b> Τραυματισμοί από κοπή</p> <ul style="list-style-type: none"> <li>▶ Φοράτε προστατευτικά γάντια.</li> </ul>

	<b>⚠ ΠΡΟΣΟΧΗ</b>
	<p><b>Κίνδυνοι από πτώση μερών εξαιτίας χαλαρών βιδών!</b> Τραυματισμός εξαιτίας πτώσης τμημάτων.</p> <ul style="list-style-type: none"> <li>▶ Ασφαλίστε τα εξαρτήματα από πτώση.</li> </ul>

	<b>ΠΡΟΣΟΧΗ!</b>
	<p><b>Κίνδυνων από πτώση εξαρτημάτων εξαιτίας χαλαρών βιδών!</b> Ζημιά σε άλλα μέρη της συσκευής ή στην οικία του πελάτη, π.χ. δάπεδο.</p> <ul style="list-style-type: none"> <li>▶ Ασφαλίστε τα εξαρτήματα από πτώση.</li> </ul>

### Προϋπόθεση:

- ✔ Η συσκευή είναι αποσυνδεδεμένη από την παροχή τροφοδοσίας.
- ✔ Η συσκευή είναι αποσυνδεδεμένη από την παροχή νερού.
- ✔ [Έχει αφαιρεθεί το καπάκι εργασίας.→199](#)
- ✔ [Έχει αφαιρεθεί το συρτάρι απορρυπαντικού.→200](#)

### 4.4.1 Αφαίρεση μετώπης

1. 1. Αφαιρέστε τις βίδες (1).
2. Απασφαλίστε τα στοιχεία συγκράτησης (2, 3).

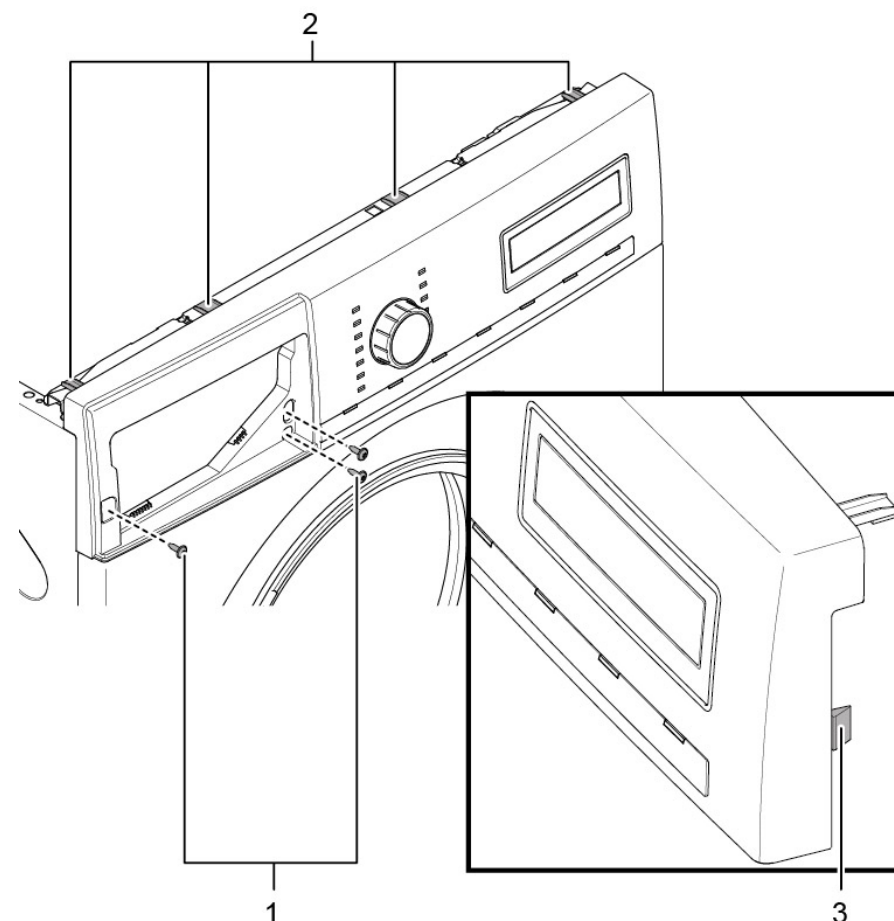

2. Απασφαλίστε την επαφή βύσματος της πλακέτας ελέγχου.
3. Αφαιρέστε τη μετώπη.

### 4.4.2 Τοποθέτηση μετώπης



Προσέξτε την εγκατάσταση των καλωδίων. Το καλώδιο θα μπορούσε να παγιδευτεί.

- ▶ Εγκαταστήστε με την αντίθετη σειρά.

## 4.5 Αντικατάσταση πόρτας



### ΠΡΟΣΟΧΗ

**Ανοίξτε την περιοχή με τους μεντεσέδες!**

Σύνθλιψη/παγίδευση δακτύλων

- ▶ Μην αγγίζετε την περιοχή με τους μεντεσέδες.
- ▶ Φοράτε προστατευτικά γάντια.



### ΠΡΟΣΟΧΗ

**Κίνδυνοι από πτώση μερών εξαιτίας χαλαρών βιδών!**

Τραυματισμός εξαιτίας πτώσης τμημάτων.

- ▶ Ασφαλίστε τα εξαρτήματα από πτώση.



### ΠΡΟΣΟΧΗ!

**Κίνδυνων από πτώση εξαρτημάτων εξαιτίας χαλαρών βιδών!**

Ζημιά σε άλλα μέρη της συσκευής ή στην οικία του πελάτη, π.χ. δάπεδο.

- ▶ Ασφαλίστε τα εξαρτήματα από πτώση.

### Προϋπόθεση:

- ✔ Η συσκευή είναι αποσυνδεδεμένη από την παροχή τροφοδοσίας.
- ✔ Η συσκευή είναι αποσυνδεδεμένη από την παροχή νερού.
- ✔ Η πόρτα είναι ανοιχτή.

## 4.5.1 Αφαίρεση πόρτας

1. Αφαιρέστε τις βίδες (1).

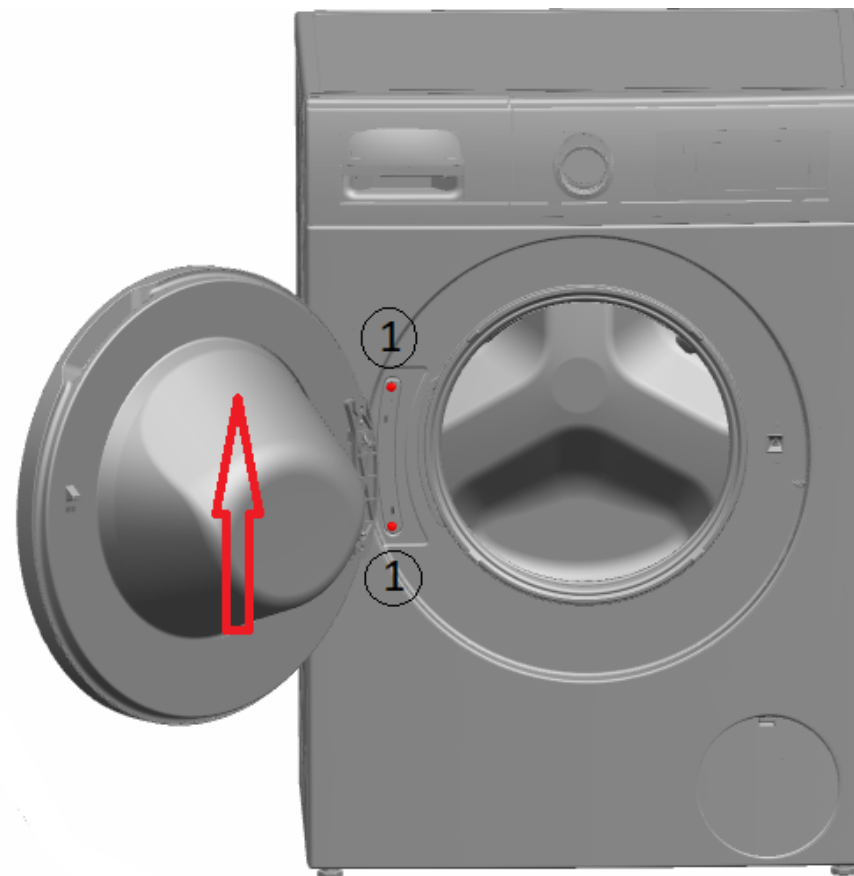



2. Αφαιρέστε την θύρα προς τα επάνω.

## 4.5.2 Τοποθέτηση πόρτας

- ▶ Εγκαταστήστε με την αντίθετη σειρά.

## 4.6 Αντικατάσταση εξαρτημάτων πόρτας

	<b>⚠️ ΠΡΟΕΙΔΟΠΟΙΗΣΗ</b>
	<b>Βαριά και κινούμενα μέρη!</b> Κίνδυνος σύνθλιψης κατά την επισκευή, συντήρηση, αντιμετώπιση προβλημάτων και το σέρβις. <ul style="list-style-type: none"><li>▶ Φοράτε προστατευτικά υποδήματα.</li><li>▶ Ασφαλίστε τα βαριά μέρη από πτώση.</li><li>▶ Μην προσαρτάτε μέρη του πλαισίου στα κινούμενα μέρη.</li></ul>

	<b>⚠️ ΠΡΟΣΟΧΗ</b>
	<b>Ανοίξτε την περιοχή με τους μεντεσέδες!</b> Σύνθλιψη/παγίδευση δακτύλων. <ul style="list-style-type: none"><li>▶ Μην αγγίζετε την περιοχή με τους μεντεσέδες.</li><li>▶ Φοράτε προστατευτικά γάντια.</li></ul>

### Προϋπόθεση:

- ✔ Η συσκευή είναι αποσυνδεδεμένη από την παροχή τροφοδοσίας.
- ✔ Η συσκευή είναι αποσυνδεδεμένη από την παροχή νερού.
- ✔ [Η πόρτα έχει αφαιρεθεί. → 204](#)

### 4.6.1 Αφαίρεση εξαρτημάτων πόρτας

- ▶ Αποσυναρμολογήστε την πόρτα από έξω προς τα μέσα.

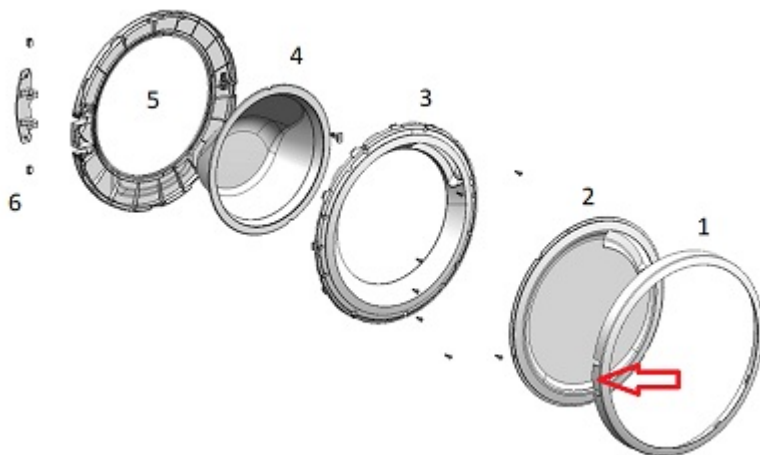

### 4.6.2 Τοποθέτηση εξαρτημάτων πόρτας

- ▶ Εγκαταστήστε με την αντίθετη σειρά.

## 4.7 Αντικατάσταση καλύμματος αντλίας

### Προϋπόθεση:

- ✓ Η συσκευή είναι αποσυνδεδεμένη από την παροχή τροφοδοσίας.
- ✓ Η συσκευή είναι αποσυνδεδεμένη από την παροχή νερού.

### 4.7.1 Αφαίρεση καλύμματος αντλίας

1. Ανοίξτε το κάλυμμα της αντλίας.

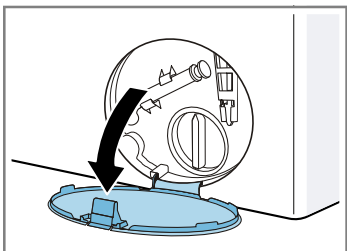

2. Αφαιρέστε το κάλυμμα της αντλίας.

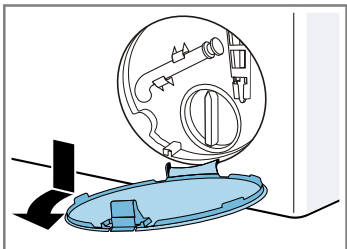



### 4.7.2 Τοποθέτηση καλύμματος αντλίας

- ▶ Εγκαταστήστε με την αντίθετη σειρά.

## 4.8 Αντικατάσταση στεγανοποιητικού πόρτας

	<b>ΠΡΟΣΟΧΗ</b> <b>Αιχμηρά άκρα περιβλήματος!</b> Τραυματισμοί από κοπή ▶ Φοράτε προστατευτικά γάντια.
--	--

	<b>ΠΡΟΣΟΧΗ</b> <b>Κίνδυνοι από πτώση μερών εξαιτίας χαλαρών βιδών!</b> Τραυματισμός εξαιτίας πτώσης τμημάτων. ▶ Ασφαλίστε τα εξαρτήματα από πτώση.
--	---

	<b>ΠΡΟΣΟΧΗ!</b> <b>Κίνδυνων από πτώση εξαρτημάτων εξαιτίας χαλαρών βιδών!</b> Ζημιά σε άλλα μέρη της συσκευής ή στην οικία του πελάτη, π.χ. δάπεδο. ▶ Ασφαλίστε τα εξαρτήματα από πτώση.
--	---

### Προϋπόθεση:

- ✓ Η συσκευή είναι αποσυνδεδεμένη από την παροχή τροφοδοσίας.
- ✓ Η συσκευή είναι αποσυνδεδεμένη από την παροχή νερού.
- ✓ Η πρόσβαση στις συσκευές είναι ελεύθερη.
- ✓ [Έχει αφαιρεθεί το καπάκι εργασίας.→199](#)
- ✓ [Έχει αφαιρεθεί το συρτάρι απορρυπαντικού.→200](#)
- ✓ [Έχει αφαιρεθεί η μετώπη.→202](#)
- ✓ [Η πόρτα έχει αφαιρεθεί.→204](#)
- ✓ [Το κάλυμμα αντλίας έχει αφαιρεθεί.→206](#)
- ✓ [Έχει αφαιρεθεί ο μπροστινός πίνακας.→212](#)
- ✓ [Έχει αφαιρεθεί το φως του τυμπάνου \(προαιρετικό\).→211](#)

## 4.8.1 Αφαίρεση στεγανοποιητικού πόρτας

1. Λύστε όλες τις συνδέσεις εύκαμπτου σωλήνα.



2. Αφαιρέστε το στεγανοποιητικό της πόρτας.

## 4.8.2 Τοποθέτηση στεγανοποιητικού πόρτας

	<b>ΠΡΟΕΙΔΟΠΟΙΗΣΗ</b> <b>Κίνδυνος από πτώση μερών εξαιτίας εσφαλμένης εγκατάστασης!</b> Τραυματισμός ή βλάβη στη συσκευή. ▶ Σφίξτε τον δακτύλιο τάνυσης για το λάστιχο της πόρτας με 3,4 Nm. ▶ Εγκαταστήστε με την αντίθετη σειρά.
--	---

## 4.9 Αντικατάσταση ασφάλειας πόρτας

Ως κατασκευαστής, υποχρεούμαστε να παρέχουμε στους πελάτες την ανταλλακτική ασφάλεια πόρτας, συμπεριλαμβανομένων των οδηγιών επισκευής σύμφωνα με τον Κανονισμό (ΕΕ) 2019/2023. Ωστόσο, θα θέλαμε να επισημάνουμε ότι μετά την αντικατάσταση της ασφάλειας πόρτας, απαιτείται ένας έλεγχος ηλεκτροτεχνικής ασφάλειας από εκπαιδευμένο ηλεκτρολόγο πριν τεθεί σε λειτουργία η συσκευή. Αυτό το άτομο πρέπει να είναι αποδεδειγμένα εκπαιδευμένο σύμφωνα με τους νόμους, τους κανονισμούς και τα πρότυπα της συγκεκριμένης χώρας.

	<b>⚠ ΚΙΝΔΥΝΟΣ</b>
	<p><b>Κίνδυνος ηλεκτροπληξίας λόγω ηλεκτροφόρων μερών!</b> Κίνδυνος για τη ζωή από ηλεκτροπληξία σε περίπτωση ακατάλληλης επισκευής</p> <ul style="list-style-type: none"> <li>▶ Τα ηλεκτρικά μέρη πρέπει να επισκευάζονται από εκπαιδευμένους ηλεκτρολόγους.</li> <li>▶ Μετά την επισκευή πραγματοποιήστε έλεγχο ασφάλειας σύμφωνα με το VDE 0701 ή κανονισμούς της συγκεκριμένης χώρας.</li> </ul>

	<b>⚠ ΠΡΟΕΙΔΟΠΟΙΗΣΗ</b>
	<p><b>Ολίσθηση κεκλιμένων συσκευών!</b> Κατάγματα οστών/τραυματισμοί σύνθλιψης</p> <ul style="list-style-type: none"> <li>▶ Ασφαλίστε τις συσκευές από ολίσθηση.</li> </ul>

	<b>⚠ ΠΡΟΣΟΧΗ</b>
	<p><b>Αιχμηρά άκρα περιβλήματος!</b> Τραυματισμοί από κοπή</p> <ul style="list-style-type: none"> <li>▶ Φοράτε προστατευτικά γάντια.</li> </ul>

	<b>⚠ ΠΡΟΣΟΧΗ</b>
	<p><b>Κίνδυνοι από πτώση μερών εξαιτίας χαλαρών βιδών!</b> Τραυματισμός εξαιτίας πτώσης τμημάτων.</p> <ul style="list-style-type: none"> <li>▶ Ασφαλίστε τα εξαρτήματα από πτώση.</li> </ul>

	<b>ΠΡΟΣΟΧΗ!</b>
	<p><b>Κίνδυνων από πτώση εξαρτημάτων εξαιτίας χαλαρών βιδών!</b> Ζημιά σε άλλα μέρη της συσκευής ή στην οικία του πελάτη, π.χ. δάπεδο.</p> <ul style="list-style-type: none"> <li>▶ Ασφαλίστε τα εξαρτήματα από πτώση.</li> </ul>

### Προϋπόθεση:

- ✓ Η συσκευή είναι αποσυνδεδεμένη από την παροχή τροφοδοσίας.
- ✓ Η συσκευή είναι αποσυνδεδεμένη από την παροχή νερού.
- ✓ Η πρόσβαση στις συσκευές είναι ελεύθερη.
- ✓ [Έχει αφαιρεθεί το καπάκι εργασίας.→199](#)
- ✓ [Έχει αφαιρεθεί το συρτάρι απορρυπαντικού.→200](#)
- ✓ [Έχει αφαιρεθεί η μετώπη.→202](#)
- ✓ [Η πόρτα έχει αφαιρεθεί.→204](#)
- ✓ Έχει αφαιρεθεί ο δακτύλιος τάνυσης.
- ✓ [Έχει αφαιρεθεί το στεγανοποιητικό πόρτας.→207](#)
- ✓ [Το κάλυμμα αντλίας έχει αφαιρεθεί.→206](#)
- ✓ [Έχει αφαιρεθεί ο μπροστινός πίνακας.→212](#)

### 4.9.1 Αφαίρεση ασφάλειας πόρτας

1. Αποσυνδέστε το βύσμα ασφάλειας πόρτας.
2. Απασφαλίστε την ασφάλεια πόρτας.



3. Αφαιρέστε την ασφάλεια πόρτας.

#### 4.9.2 Τοποθέτηση ασφάλειας πόρτας

Η ασφάλεια πόρτας πρέπει να βρίσκεται στη σωστή θέση για να είναι βέβαιη η λειτουργία ανοίγματος της πόρτας έκτακτης ανάγκης της συσκευής.

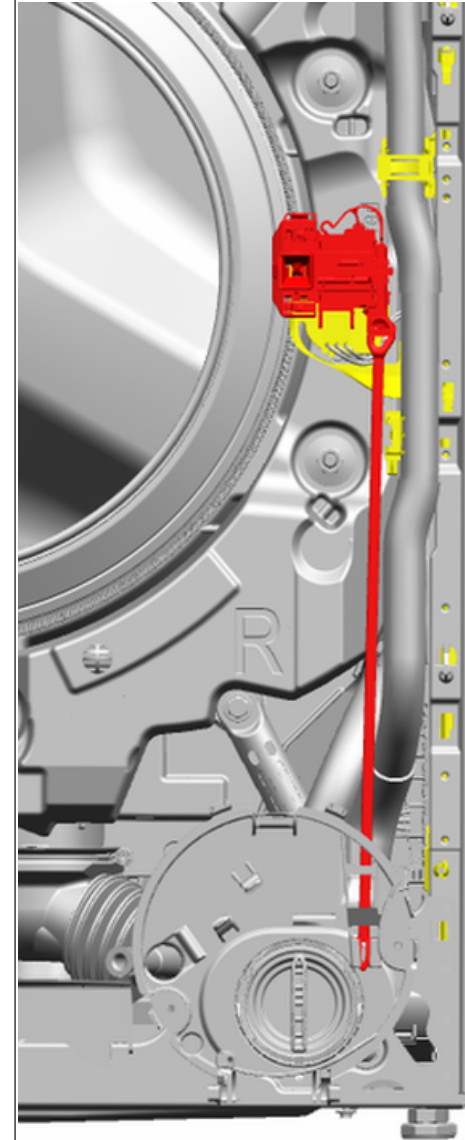

- ▶ Εγκαταστήστε με την αντίθετη σειρά.

## 4.10 Αντικατάσταση φωτισμού τυμπάνου



### ΠΡΟΕΙΔΟΠΟΙΗΣΗ

**Ολίσθηση κεκλιμένων συσκευών!**  
Κατάγματα οστών/τραυματισμοί σύνθλιψης  
▶ Ασφαλίστε τις συσκευές από ολίσθηση.



### ΠΡΟΣΟΧΗ

**Αιχμηρά άκρα περιβλήματος!**  
Τραυματισμοί από κοπή  
▶ Φοράτε προστατευτικά γάντια.



### ΠΡΟΣΟΧΗ

**Κίνδυνοι από πτώση μερών εξαιτίας χαλαρών βιδών!**  
Τραυματισμός εξαιτίας πτώσης τμημάτων.  
▶ Ασφαλίστε τα εξαρτήματα από πτώση.



### ΠΡΟΣΟΧΗ!

**Κίνδυνων από πτώση εξαρτημάτων εξαιτίας χαλαρών βιδών!**  
Ζημιά σε άλλα μέρη της συσκευής ή στην οικία του πελάτη, π.χ. δάπεδο.  
▶ Ασφαλίστε τα εξαρτήματα από πτώση.

### Προϋπόθεση:

- ✓ Η συσκευή είναι αποσυνδεμένη από την παροχή τροφοδοσίας.
- ✓ Η συσκευή είναι αποσυνδεμένη από την παροχή νερού.
- ✓ Η πρόσβαση στις συσκευές είναι ελεύθερη.
- ✓ [Έχει αφαιρεθεί το καπάκι εργασίας.→199](#)
- ✓ [Έχει αφαιρεθεί το συρτάρι απορρυπαντικού.→200](#)
- ✓ [Έχει αφαιρεθεί η μετώπη.→202](#)

## 4.10.1 Αφαίρεση φωτισμού τυμπάνου

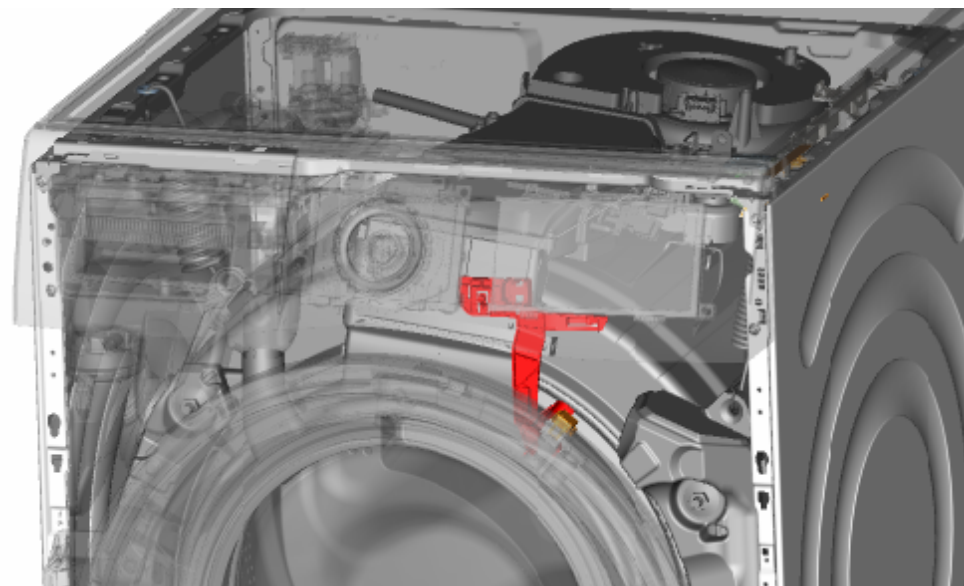

1. Αφαιρέστε τη βάση του φωτισμού τυμπάνου από τη συσκευή.
2. Αποσυνδέστε τις ηλεκτρικές συνδέσεις.
3. Αφαιρέστε τον φωτισμό τυμπάνου από τη βάση του φωτισμού τυμπάνου.





## 4.10.2 Τοποθέτηση φωτισμού τυμπάνου



Προσέξτε την εγκατάσταση των καλωδίων. Το καλώδιο θα μπορούσε να παγιδευτεί.

- ▶ Εγκαταστήστε με την αντίθετη σειρά.

## 4.11 Αντικατάσταση μπροστινού πίνακα

	<p><b>⚠ ΠΡΟΕΙΔΟΠΟΙΗΣΗ</b></p> <p><b>Ολίσθηση κεκλιμένων συσκευών!</b> Κατάγματα οστών/τραυματισμοί σύνθλιψης</p> <ul style="list-style-type: none"> <li>▶ Ασφαλίστε τις συσκευές από ολίσθηση.</li> </ul>
	<p><b>⚠ ΠΡΟΣΟΧΗ</b></p> <p><b>Αιχμηρά άκρα περιβλήματος!</b> Τραυματισμοί από κοπή</p> <ul style="list-style-type: none"> <li>▶ Φοράτε προστατευτικά γάντια.</li> </ul>
	<p><b>⚠ ΠΡΟΣΟΧΗ</b></p> <p><b>Κίνδυνοι από πτώση μερών εξαιτίας χαλαρών βιδών!</b> Τραυματισμός εξαιτίας πτώσης τμημάτων.</p> <ul style="list-style-type: none"> <li>▶ Ασφαλίστε τα εξαρτήματα από πτώση.</li> </ul>
	<p><b>ΠΡΟΣΟΧΗ!</b></p> <p><b>Κίνδυνων από πτώση εξαρτημάτων εξαιτίας χαλαρών βιδών!</b> Ζημιά σε άλλα μέρη της συσκευής ή στην οικία του πελάτη, π.χ. δάπεδο.</p> <ul style="list-style-type: none"> <li>▶ Ασφαλίστε τα εξαρτήματα από πτώση.</li> </ul>

### Προϋπόθεση:

- ✔ Η συσκευή είναι αποσυνδεδεμένη από την παροχή τροφοδοσίας.
- ✔ Η συσκευή είναι αποσυνδεδεμένη από την παροχή νερού.
- ✔ Η πρόσβαση στις συσκευές είναι ελεύθερη.
- ✔ [Έχει αφαιρεθεί το καπάκι εργασίας.→199](#)
- ✔ [Έχει αφαιρεθεί το συρτάρι απορρυπαντικού.→200](#)
- ✔ [Έχει αφαιρεθεί η μετώπη.→202](#)
- ✔ [Η πόρτα έχει αφαιρεθεί.→204](#)
- ✔ [Το κάλυμμα αντλίας έχει αφαιρεθεί.→206](#)
- ✔ Έχει αφαιρεθεί ο δακτύλιος τάνυσης.
- ✔ Έχει αφαιρεθεί το μπροστινό στεγανοποιητικό πόρτας.
- ✔ [Έχει αφαιρεθεί το φως του τυμπάνου \(προαιρετικό\).→211](#)

### 4.11.1 Αφαίρεση μπροστινού πίνακα

1. Ανασηκώστε τη συσκευή μπροστά.

2. Αφαιρέστε τις βίδες στο κάτω μέρος (1).

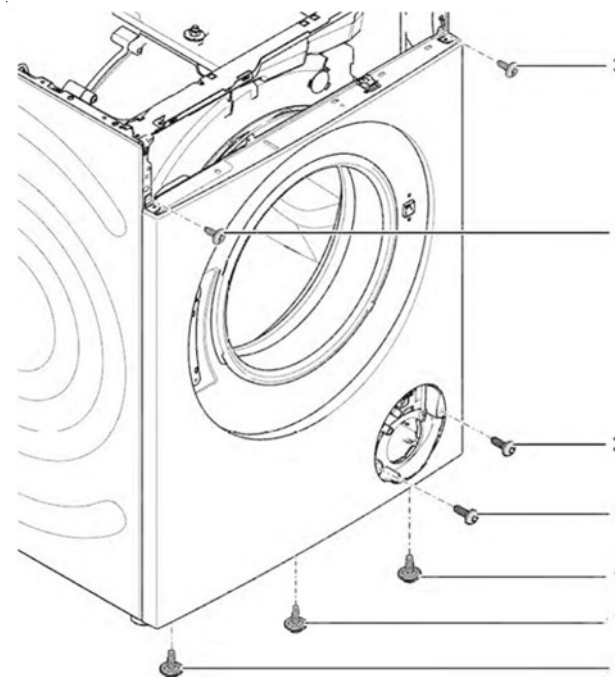

3. Κατεβάστε τη συσκευή.

4. Αφαιρέστε τις βίδες στο μπροστινό μέρος από κάτω προς τα επάνω (2, 3).

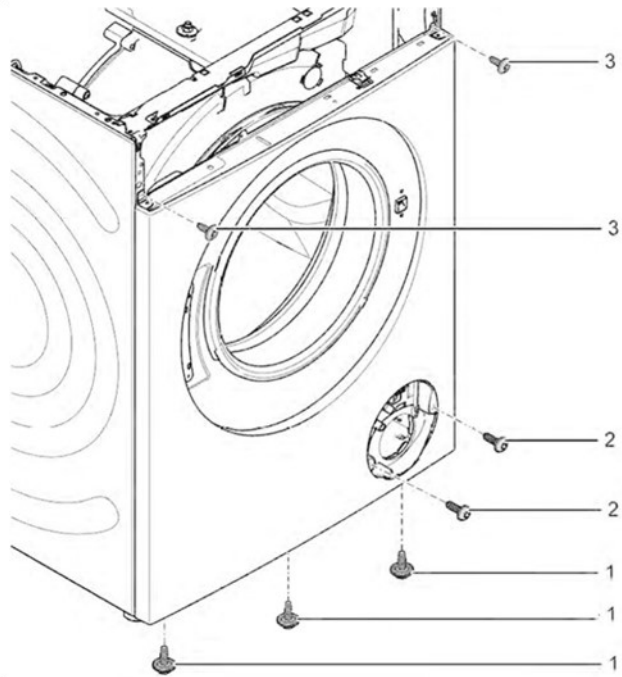

5. Αφαιρέστε τον μπροστινό πίνακα.

### 4.11.2 Τοποθέτηση μπροστινής μετώπης

- ▶ Εγκαταστήστε με την αντίθετη σειρά.

# Javítási útmutató - Mosógép

## **A dokumentummal kapcsolatos információk..... 215**

1.1	Fontos tudnivalók .....	215
1.1.1	Cél .....	215
1.2	Szimbólummagyarázat .....	215
1.2.1	Veszélyességi szintek .....	215
1.2.2	Veszélyt jelző szimbólumok .....	215
1.2.3	A figyelmeztetések felépítése .....	216
1.2.4	Általános szimbólumok.....	216

## **Biztonság ..... 217**

2.1	Általános biztonsági utasítások.....	217
2.1.1	Összes háztartási készülék .....	217

## **Szerszámok és segédanyagok..... 218**

## **Javítás ..... 219**

4.1	A felső burkolat cseréje.....	219
4.1.1	A felső burkolat eltávolítása .....	219
4.1.2	A felső burkolat elhelyezése .....	219
4.2	A mosószer-adagoló cseréje .....	220
4.2.1	A mosószer-adagoló eltávolítása .....	220
4.2.2	A mosószer-adagoló behelyezése.....	220
4.3	A mosószer-adagoló fogantyújának cseréje .....	221
4.3.1	A mosószer-adagoló fogantyújának eltávolítása.....	221
4.3.2	A mosószer-adagoló fogantyújának behelyezése.....	221
4.4	A vezérlőpanel cseréje.....	222
4.4.1	A vezérlőpanel eltávolítása .....	222
4.4.2	A vezérlőpanel telepítése .....	223
4.5	Az ajtó cseréje.....	224
4.5.1	Az ajtó eltávolítása .....	224
4.5.2	Az ajtó felhelyezése .....	224
4.6	Az ajtó alkatrészeinek cseréje .....	225
4.6.1	Az ajtó alkatrészeinek eltávolítása.....	225
4.6.2	Az ajtó alkatrészeinek felhelyezése .....	225
4.7	A szivattyúfedél cseréje .....	226
4.7.1	A szivattyúfedél eltávolítása.....	226
4.7.2	A szivattyúfedél telepítése .....	226

4.8	A gumiömítés cseréje.....	227
4.8.1	A gumiömítés eltávolítása .....	227
4.8.2	Gumiömítés felhelyezése .....	227
4.9	Ajtózár cseréje .....	228
4.9.1	Az ajtózár eltávolítása.....	228
4.9.2	Az ajtózár behelyezése.....	229
4.10	A belső dobvilágítás cseréje .....	230
4.10.1	A belső dobvilágítás eltávolítása.....	230
4.10.2	A belső dobvilágítás telepítése .....	230
4.11	Az elülső panel cseréje.....	231
4.11.1	Az elülső panel eltávolítása .....	231
4.11.2	Az elülső panel telepítése .....	232

# **i** A dokumentummal kapcsolatos információk

## 1.1 Fontos tudnivalók

### 1.1.1 Cél

Ezek a javítási tanácsok támogatják a fogyasztót a készülékek otthoni megjavításában a környezettudatos tervezésről szóló rendeletnek (2021 márciusától alkalmazandó) megfelelően.



Információkat tartalmaznak bizonyos pótalkatrészek cseréjével kapcsolatban, ideértve a figyelmeztetéseket és a kockázatokat is.

Ha kérdése van, vegye fel a kapcsolatot a vevőszolgálattal. A károkért kizárólag akkor vállalunk felelősséget, ha a javítási tanácsokat pontosan betartották.

## 1.2 Szimbólummagyarázat

### 1.2.1 Veszélyességi szintek

A veszélyességi szintek egy szimbólumból és egy figyelmeztető mondatból állnak. A figyelmeztető mondat utal a veszély súlyosságára.





Veszélyességi szint	Jelentés
 <b>VESZÉLY</b>	A figyelmeztető üzenet figyelmen kívül hagyása halált vagy súlyos sérüléseket okoz.
 <b>FIGYELMEZTETÉS</b>	A figyelmeztető üzenet figyelmen kívül hagyása halált vagy súlyos sérüléseket okozhat.
 <b>VIGYÁZAT</b>	A figyelmeztető üzenet figyelmen kívül hagyása kisebb sérüléseket okozhat.
<b>FIGYELEM!</b>	A figyelmeztető üzenet figyelmen kívül hagyása anyagi károkat okozhat.

Táblázat 1: Veszélyességi szintek

### 1.2.2 Veszélyt jelző szimbólumok

A veszélyt jelző szimbólumok a veszélyt ábrázoló szimbolikus ábrázolások.

A jelen dokumentumban az alábbi veszélyt jelző szimbólumok használatosak:

Veszélyt jelző szimbólum	Jelentés
	Általános figyelmeztető üzenet
	Elektromos feszültség veszélye
	Robbanásveszély
	Vágásveszély
	Zúzódásveszély

## **i** A dokumentummal kapcsolatos információk

Veszélyt jelző szimbólum	Jelentés
	Forró felületek miatt fennálló veszély
	Erős mágneses mező miatt fennálló veszély
	Nem ionizáló sugárzás veszélye

Táblázat 2: Veszélyt jelző szimbólumok

### 1.2.3 A figyelmeztetések felépítése

A jelen dokumentumban lévő figyelmeztetések szabványosított megjelenésűek és felépítésűek.

	<p><b>⚠ VESZÉLY</b></p> <p><b>A veszély típusa és forrása!</b> A veszély / figyelmeztetés figyelmen kívül hagyásának lehetséges következményei.</p> <ul style="list-style-type: none"> <li>▶ A veszély megelőzésére szolgáló intézkedések és tiltások.</li> </ul>
--	---

Az alábbi példa egy olyan figyelmeztetést mutat be, amely az áram alatt lévő alkatrészek okozta áramütésre figyelmeztet. Megemlíti a veszély elkerülésére szolgáló intézkedést.

	<p><b>⚠ VESZÉLY</b></p> <p><b>Áramütés veszélye áram alatt lévő alkatrészek miatt!</b> Halálos áramütés</p> <ul style="list-style-type: none"> <li>▶ A javítás megkezdése előtt legalább 60 másodperccel válassza le a készülékeket az elektromos hálózatról.</li> </ul>
--	--

### 1.2.4 Általános szimbólumok

A jelen dokumentumban az alábbi általános szimbólumok használatosak:

Ált. szimbólum	Jelentés
	Különleges tanács (szöveg és/vagy grafika)

Ált. szimbólum	Jelentés
	Egyszerű tanács (csak szöveg)
	Videós oktatóanyagra mutató hivatkozás
	A szükséges eszközök
	A szükséges feltételek
	Feltétel (ha..., akkor...)
	Eredmény
[Indítás]	Billentyű vagy gomb
[00123456]	Anyagszám azonosítója
Állapot	Megjelenített szöveg / ablak (a készülék kijelzőjén)

Táblázat 3: Általános szimbólumok

## 2.1 Általános biztonsági utasítások

### 2.1.1 Összes háztartási készülék

#### **Áramütés veszélye áram alatt lévő alkatrészek miatt!**

- Az elektromos alkatrészek hibás javítása áramütéshez vezethet!
- A javítás megkezdése előtt legalább 60 másodperccel válassza le a készüléket az elektromos hálózatról.
- A javítás után végeztesse a VDE 0701-nek vagy az országspecifikus szabályozásoknak megfelelő vizsgálatot.

#### **Éles peremek miatt fennálló sérülésveszély!**

- Viseljen védőkesztyűt.

#### **Zúzódásveszély a javítás, karbantartás, hibaelhárítás és szervizelés során a nehéz és mozgó alkatrészek miatt**

- Viseljen védőcipőt.
- Biztosítsa leesés ellen a nehéz alkatrészeket.
- Ne dugja be a testrészeit a mozgó alkatrészek közé.







#### **Sérülhet a készülék biztonsága / működése!**



- Kizárólag eredeti pótalkatrészeket használjon.

#### **Elektrosztatikailag érzékeny alkatrészek (ESD-k) károsodásának veszélye!**

- Ne érintse meg a modulokat, ideértve a csatlakozásokat és a vezetőket.

## Szerszámok és segédanyagok

Kijelölés	Részletek	Képek
Segédeszköz [15000155]	Műanyag alkatrészek meglazítására szolgáló szerszám	
Biztonsági Torx T20 csavarhúzó [00340764]	100°mm, biztonsági csavarokhoz	
Nyomatékkulcs [15000441]	Nyomatékkulcs 20–100 Nm	
Lapos csavarhúzó [00340854]	Fej: 3,5 mm x 0,6 mm x 100 mm, Szigetelés: 1000 V AC	
Lapos csavarhúzó [00340855]	Fej: 5,5 mm x 1,0 mm x 125 mm, Szigetelés: 1000 V AC	
Hosszúcsőrű fogó, hajlított kialakítás [00341269]	Hossz: 200 mm	
Oldalcsípő fogó [00342182]	Hossz: 200 mm	
Csillag-Villáskulcs [00340811]	Méret 10°mm, M6	



Kijelölés	Részletek	Képek
Combination wrench [00340814]	Méret 13°mm, M8	
Csillag-Villáskulcs [00340817]	Méret 17 mm, M10	
Csillag-Villáskulcs [15000459]	Méret 16°mm, M10	

## 4.1 A felső burkolat cseréje

### Különleges eszközök

-  Torx Bit TX20, furatos Hossz 152 mm, használható hossz [00341272]  
124 mm, 1/4" hatszögletű csavarmeghajtó (6.35 mm), biztonsági csavarokhoz

### Követelmény:

-  A készüléket leválasztotta az áramellátásról.
-  A készüléket leválasztotta a vízellátásról.

### 4.1.1 A felső burkolat eltávolítása

- ▶ 1. Távolítsa el a csavarokat (1).
- ▶ 2. Tolja a felső burkolatot a készülék hátsó része felé (2).
- ▶ 3. Felemelve (3) távolítsa el a felső burkolatot.

### 4.1.2 A felső burkolat elhelyezése

	Tartsa be a kábeltelepítési előírásokat. Megtörténhet, hogy a kábel beszorult.
---	--

- ▶ Az elhelyezést fordított sorrendben végezze.

## 4.2 A mosószer-adagoló cseréje

### Követelmény:

- ✔ A készüléket leválasztotta az áramellátásról.
- ✔ A készüléket leválasztotta a vízellátásról.

### 4.2.1 A mosószer-adagoló eltávolítása

1. Húzza ki a mosószer-adagoló rekeszt.
2. 1. Nyomja le a fiókot (1).  
2. Távolítsa el a mosószer-adagoló rekeszt (2).

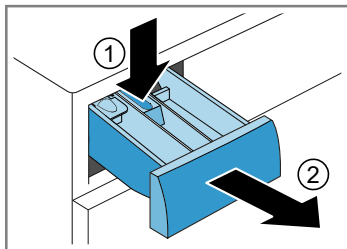

### 4.2.2 A mosószer-adagoló behelyezése

- ▶ Az elhelyezést fordított sorrendben végezze.

## 4.3 A mosószer-adagoló fogantyújának cseréje

### Követelmény:

- ✔ A készüléket leválasztotta az áramellátásról.
- ✔ A készüléket leválasztotta a vízellátásról.
- ✔ [Eltávolította a mosószer-adagolót.→220](#)

### 4.3.1 A mosószer-adagoló fogantyújának eltávolítása

1. Lazítsa meg a rögzítőelemeket.

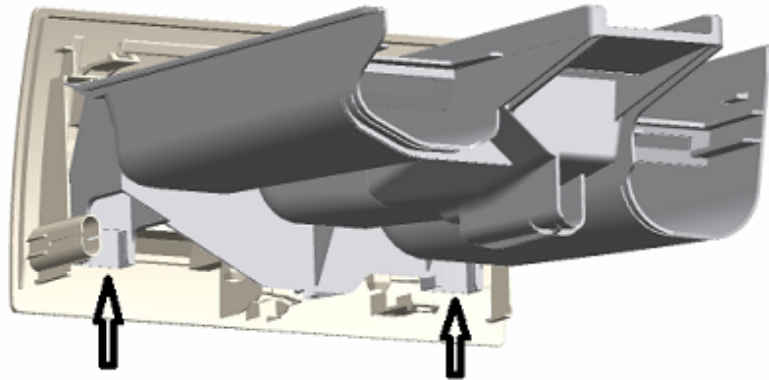

2. Távolítsa el a mosószer-adagoló rekesz fogantyúját.

### 4.3.2 A mosószer-adagoló fogantyújának behelyezése

- ▶ Az elhelyezést fordított sorrendben végezze.

## 4.4 A vezérlőpanel cseréje

Gyártóként kötelességünk tartalék alkatrészként vezérlőpanelt biztosítani a vásárlók számára, beleértve a javítási utasításokat is az (EU) 2019/2023 rendeletnek megfelelően. Felhívjuk a figyelmét, hogy a vezérlőpanel cseréje után egy képzett elektroműszerésznek elektrotechnikai biztonsági vizsgálatot kell végeznie a készülék üzembe helyezése előtt. A vizsgálatot végző személynek az adott ország jogszabályai, szabályozásai és szabványai szerint meghatározott képesítéssel kell rendelkeznie.

	<p style="text-align: center;"><b>⚠ VESZÉLY</b></p> <p><b>Áramütés veszélye áram alatt lévő alkatrészek miatt!</b> Életveszély a nem megfelelő javítás okozta áramütés miatt</p> <ul style="list-style-type: none"> <li>▶ Az elektromos alkatrészek javítását kizárólag képzett elektroműszerész végezheti.</li> <li>▶ A javítás után végeztessen a VDE 0701-nek vagy az országspecifikus szabályozásoknak megfelelő vizsgálatot.</li> </ul>
	<p style="text-align: center;"><b>⚠ FIGYELMEZTETÉS</b></p> <p><b>Megdöntött készülékek elcsúszása!</b> Csonttörés / zúzódási sérülések</p> <ul style="list-style-type: none"> <li>▶ Biztosítsa a készülékeket elcsúszás ellen.</li> </ul>
	<p style="text-align: center;"><b>⚠ VIGYÁZAT</b></p> <p><b>Éles burkolatszélék!</b> Vágási sérülések</p> <ul style="list-style-type: none"> <li>▶ Viseljen védőkesztyűt.</li> </ul>
	<p style="text-align: center;"><b>⚠ VIGYÁZAT</b></p> <p><b>Leeső alkatrészek veszélye a kioldott csavarok miatt!</b> Leeső alkatrészek miatti sérülés.</p> <ul style="list-style-type: none"> <li>▶ Biztosítsa az alkatrészt leesés ellen.</li> </ul>
	<p style="text-align: center;"><b>FIGYELEM!</b></p> <p><b>Leeső alkatrészek veszélye a kioldott csavarok miatt!</b> A készülék többi részeinek vagy az ügyfél lakásának (pl. padló) károsodása.</p> <ul style="list-style-type: none"> <li>▶ Biztosítsa az alkatrészt leesés ellen.</li> </ul>

### Követelmény:

- ✓ A készüléket leválasztotta az áramellátásról.

- ✓ A készüléket leválasztotta a vízellátásról.
- ✓ [Eltávolította a felső burkolatot. →219](#)
- ✓ [Eltávolította a mosószer-adagolót. →220](#)

### 4.4.1 A vezérlőpanel eltávolítása

1. Távolítsa el a csavarokat (1).
2. Lazítsa meg a rögzítőelemeket (2, 3).

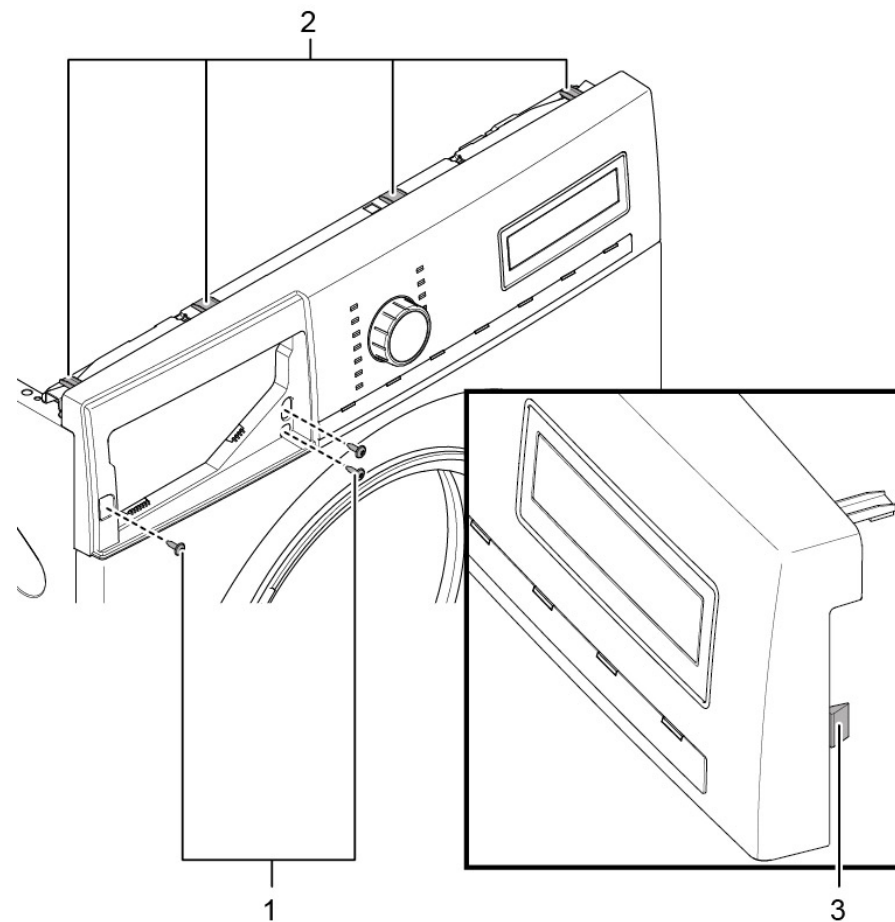

2. Húzza ki a vezérlőegység dugaszát.
3. Távolítsa el a vezérlőpanelt.

#### 4.4.2 A vezérlőpanel telepítése



Tartsa be a kábeltelepítési előírásokat. Megtörténhet, hogy a kábel beszorult.

- ▶ Az elhelyezést fordított sorrendben végezze.

## 4.5 Az ajtó cseréje



### VIGYÁZAT

#### Nyitott zsanér!

Ujjak zúzódása/beszorulása

- ▶ Ne nyúljon be a nyitott zsanérba.
- ▶ Viseljen védőkesztyűt.



### VIGYÁZAT

#### Leeső alkatrészek veszélye a kioldott csavarok miatt!

Leeső alkatrészek miatti sérülés.

- ▶ Biztosítsa az alkatrészt leesés ellen.



### FIGYELEM!

#### Leeső alkatrészek veszélye a kioldott csavarok miatt!

A készülék többi részeinek vagy az ügyfél lakásának (pl. padló) károsodása.

- ▶ Biztosítsa az alkatrészt leesés ellen.

#### Követelmény:

- ✓ A készüléket leválasztotta az áramellátásról.
- ✓ A készüléket leválasztotta a vízellátásról.
- ✓ Az ajtó nyitva van.

### 4.5.1 Az ajtó eltávolítása

1. Távolítsa el a csavarokat (1).

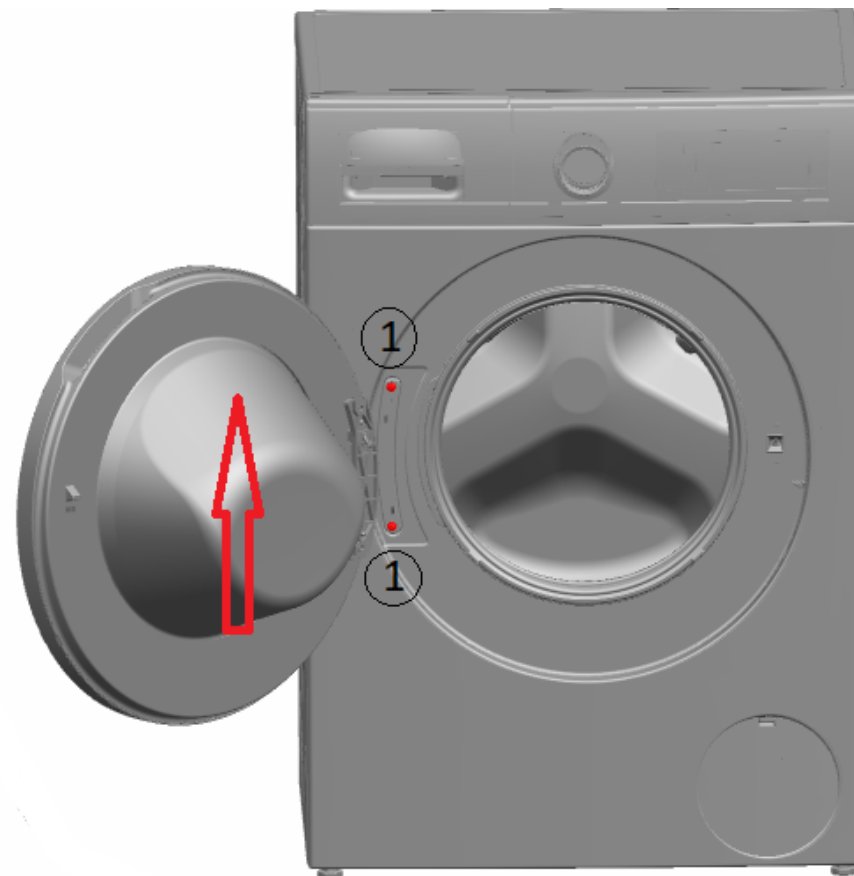



2. Felfelé húzva távolítsa el az ajtót.

### 4.5.2 Az ajtó felhelyezése

- ▶ Az elhelyezést fordított sorrendben végezze.

## 4.6 Az ajtó alkatrészeinek cseréje

	<b>⚠ FIGYELMEZTETÉS</b>
	<b>Nehéz és mozgó alkatrészek!</b> Zúzódásveszély a javítás, karbantartás, hibaelhárítás és szervizelés során <ul style="list-style-type: none"><li>▶ Viseljen védőcipőt.</li><li>▶ Biztosítsa leesés ellen a nehéz alkatrészeket.</li><li>▶ Ne dugja be a testrészeit a mozgó alkatrészek közé.</li></ul>

	<b>⚠ VIGYÁZAT</b>
	<b>Nyitott zsanér!</b> Ujjak zúzódása/beszorulása <ul style="list-style-type: none"><li>▶ Ne nyúljon be a nyitott zsanérba.</li><li>▶ Viseljen védőkesztyűt.</li></ul>

### Követelmény:

- ✓ A készüléket leválasztotta az áramellátásról.
- ✓ A készüléket leválasztotta a vízellátásról.
- ✓ [Eltávolította az ajtót.→224](#)

### 4.6.1 Az ajtó alkatrészeinek eltávolítása

- ▶ Kívülről befelé haladva szerelje szét az ajtót.

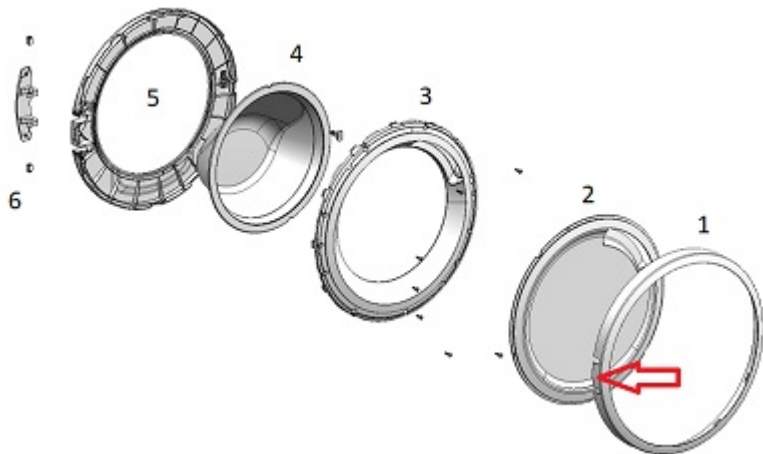

### 4.6.2 Az ajtó alkatrészeinek felhelyezése

- ▶ Az elhelyezést fordított sorrendben végezze.

## 4.7 A szivattyúfedél cseréje

### Követelmény:

- ✔ A készüléket leválasztotta az áramellátásról.
- ✔ A készüléket leválasztotta a vízellátásról.

### 4.7.1 A szivattyúfedél eltávolítása

1. Nyissa fel a szivattyú fedelét.

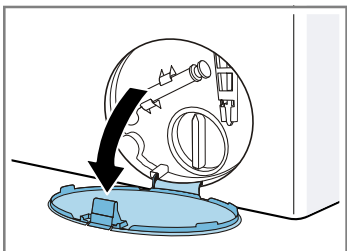

2. Távolítsa el a szivattyú fedelét.

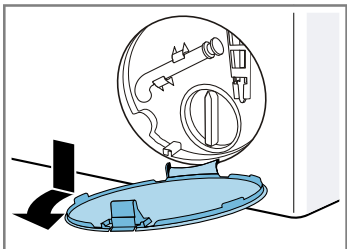



### 4.7.2 A szivattyúfedél telepítése

- ▶ Az elhelyezést fordított sorrendben végezze.

## 4.8 A gumitömítés cseréje

	<b>VIGYÁZAT</b> <b>Éles burkolatszélék!</b> Vágási sérülések ▶ Viseljen védőkesztyűt.
--	--

	<b>VIGYÁZAT</b> <b>Leeső alkatrészek veszélye a kioldott csavarok miatt!</b> Leeső alkatrészek miatti sérülés. ▶ Biztosítsa az alkatrészt leesés ellen.
--	--

	<b>FIGYELEM!</b> <b>Leeső alkatrészek veszélye a kioldott csavarok miatt!</b> A készülék többi részeinek vagy az ügyfél lakásának (pl. padló) károsodása. ▶ Biztosítsa az alkatrészt leesés ellen.
--	---

### Követelmény:

- ✓ A készüléket leválasztotta az áramellátásról.
- ✓ A készüléket leválasztotta a vízellátásról.
- ✓ A készülékek szabadon hozzáférhetők.
- ✓ [Eltávolította a felső burkolatot.→219](#)
- ✓ [Eltávolította a mosószer-adagolót.→220](#)
- ✓ [A vezérlőpanelt eltávolították.→222](#)
- ✓ [Eltávolította az ajtót.→224](#)
- ✓ [Eltávolította a szivattyűfedelelet.→226](#)
- ✓ [Az elülső panelt eltávolították.→231](#)
- ✓ [Eltávolította a belső dobvilágítást \(opcionális\).→230](#)

### 4.8.1 A gumitömítés eltávolítása

1. Szüntesse meg a tömlőcsatlakozásokat.

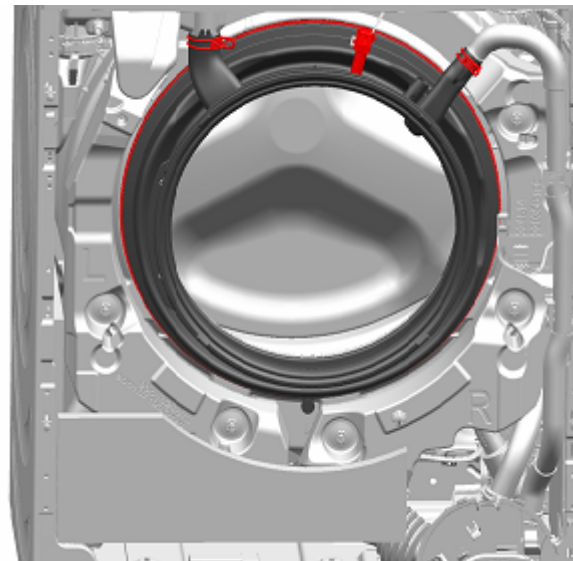

2. Távolítsa el a gumitömítést.

### 4.8.2 Gumitömítés felhelyezése

	<b>FIGYELMEZTETÉS</b> <b>Leeső alkatrészek veszélye a nem megfelelő telepítés miatt!</b> Sérülés vagy a készülék károsodásának veszélye ▶ Húzza meg az üstszejgumi szorítógyűrűjét 3,4 Nm nyomatékkal.
--	---

- ▶ Az elhelyezést fordított sorrendben végezze.

## 4.9 Ajtózár cseréje

Gyártóként kötelességünk tartalék alkatrészként ajtózárat biztosítani a vásárlók számára, beleértve a javítási utasításokat is az (EU) 2019/2023 rendeletnek megfelelően. Felhívjuk a figyelmét, hogy az ajtózár cseréje után egy képzett elektroműszerésznek elektrotechnikai biztonsági vizsgálatot kell végeznie a készülék üzembe helyezése előtt. A vizsgálatot végző személynek az adott ország jogszabályai, szabályozásai és szabványai szerint meghatározott képesítéssel kell rendelkeznie.

	<b>⚠ VESZÉLY</b> <b>Áramütés veszélye áram alatt lévő alkatrészek miatt!</b> Életveszély a nem megfelelő javítás okozta áramütés miatt <ul style="list-style-type: none"><li>▶ Az elektromos alkatrészek javítását kizárólag képzett elektroműszerész végezheti.</li><li>▶ A javítás után végeztessen a VDE 0701-nek vagy az országspecifikus szabályozásoknak megfelelő vizsgálatot.</li></ul>
--	---

	<b>⚠ FIGYELMEZTETÉS</b> <b>Megdöntött készülékek elcsúszása!</b> Csonttörés / zúzódási sérülések <ul style="list-style-type: none"><li>▶ Biztosítsa a készülékeket elcsúszás ellen.</li></ul>
--	---

	<b>⚠ VIGYÁZAT</b> <b>Éles burkolatszélék!</b> Vágási sérülések <ul style="list-style-type: none"><li>▶ Viseljen védőkesztyűt.</li></ul>
--	---

	<b>⚠ VIGYÁZAT</b> <b>Leeső alkatrészek veszélye a kioldott csavarok miatt!</b> Leeső alkatrészek miatti sérülés. <ul style="list-style-type: none"><li>▶ Biztosítsa az alkatrészt leesés ellen.</li></ul>
--	---

	<b>FIGYELEM!</b> <b>Leeső alkatrészek veszélye a kioldott csavarok miatt!</b> A készülék többi részeinek vagy az ügyfél lakásának (pl. padló) károsodása. <ul style="list-style-type: none"><li>▶ Biztosítsa az alkatrészt leesés ellen.</li></ul>
--	--

### Követelmény:

- ✓ A készüléket leválasztotta az áramellátásról.

- ✓ A készüléket leválasztotta a vízellátásról.
- ✓ A készülékek szabadon hozzáférhetők.
- ✓ [Eltávolította a felső burkolatot. → 219](#)
- ✓ [Eltávolította a mosószer-adagolót. → 220](#)
- ✓ [A vezérlőpanelt eltávolították. → 222](#)
- ✓ [Eltávolította az ajtót. → 224](#)
- ✓ A feszítőgyűrűt eltávolították.
- ✓ [A gumitömítést eltávolították. → 227](#)
- ✓ [Eltávolította a szivattyúfedelelet. → 226](#)
- ✓ [Az elülső panelt eltávolították. → 231](#)

### 4.9.1 Az ajtózár eltávolítása

1. Válassza le az ajtózár csatlakozóját.
2. Lazítsa meg az ajtózárat.



3. Vegye ki az ajtózárat.

## 4.9.2 Az ajtózár behelyezése

Az ajtózárnak megfelelő pozícióban kell lennie ahhoz, hogy a vészhelyzeti ajtónyitás működőképes legyen.

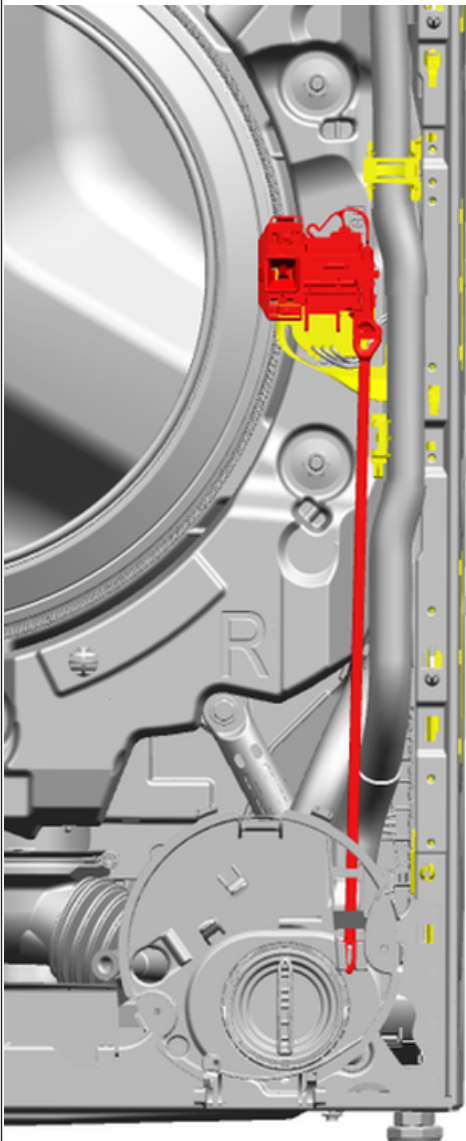

- ▶ Az elhelyezést fordított sorrendben végezze.

## 4.10 A belső dobvilágítás cseréje



### FIGYELMEZTETÉS

#### Megdöntött készülékek elcsúszása!

Csonttörés / zúzódási sérülések

- ▶ Biztosítsa a készülékeket elcsúszás ellen.



### VIGYÁZAT

#### Éles burkolatszélék!

Vágási sérülések

- ▶ Viseljen védőkesztyűt.



### VIGYÁZAT

#### Leeső alkatrészek veszélye a kioldott csavarok miatt!

Leeső alkatrészek miatti sérülés.

- ▶ Biztosítsa az alkatrészt leesés ellen.



### FIGYELEM!

#### Leeső alkatrészek veszélye a kioldott csavarok miatt!

A készülék többi részeinek vagy az ügyfél lakásának (pl. padló) károsodása.

- ▶ Biztosítsa az alkatrészt leesés ellen.

#### Követelmény:

- ✓ A készüléket leválasztotta az áramellátásról.
- ✓ A készüléket leválasztotta a vízellátásról.
- ✓ A készülékek szabadon hozzáférhetők.
- ✓ [Eltávolította a felső burkolatot.→219](#)
- ✓ [Eltávolította a mosószer-adagolót.→220](#)
- ✓ [A vezérlőpanelt eltávolították.→222](#)

## 4.10.1 A belső dobvilágítás eltávolítása

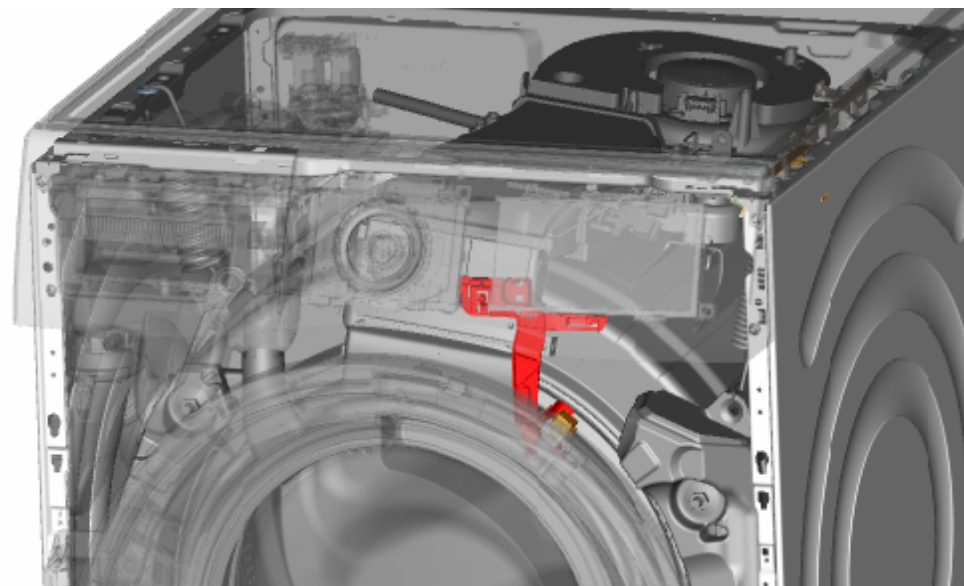

1. Húzza ki a belső dobvilágítás tartóját a készülékből.
2. Válassza le az elektromos csatlakozókat.
3. Távolítsa el a belső dobvilágítást a belső dobvilágítás tartójából.

## 4.10.2 A belső dobvilágítás telepítése



Tartsa be a kábeltelepítési előírásokat. Megtörténhet, hogy a kábel beszorult.

- ▶ Az elhelyezést fordított sorrendben végezze.

## 4.11 Az elülső panel cseréje



### FIGYELMEZTETÉS

#### Megdöntött készülékek elcsúszása!

Csonttörés / zúzódási sérülések

- ▶ Biztosítsa a készülékeket elcsúszás ellen.



### VIGYÁZAT

#### Éles burkolatszélék!

Vágási sérülések

- ▶ Viseljen védőkesztyűt.



### VIGYÁZAT

#### Leeső alkatrészek veszélye a kioldott csavarok miatt!

Leeső alkatrészek miatti sérülés.

- ▶ Biztosítsa az alkatrészt leesés ellen.



### FIGYELEM!

#### Leeső alkatrészek veszélye a kioldott csavarok miatt!

A készülék többi részeinek vagy az ügyfél lakásának (pl. padló) károsodása.

- ▶ Biztosítsa az alkatrészt leesés ellen.

#### Követelmény:

- ✓ A készüléket leválasztotta az áramellátásról.
- ✓ A készüléket leválasztotta a vízellátásról.
- ✓ A készülékek szabadon hozzáférhetők.
- ✓ [Eltávolította a felső burkolatot.→219](#)
- ✓ [Eltávolította a mosószer-adagolót.→220](#)
- ✓ [A vezérlőpanelt eltávolították.→222](#)
- ✓ [Eltávolította az ajtót.→224](#)
- ✓ [Eltávolította a szivattyúfedelelet.→226](#)
- ✓ A fessítőgyűrűt eltávolították.
- ✓ A gumitömítést eltávolították a készülék elején.
- ✓ [Eltávolította a belső dobvilágítást \(opcionális\).→230](#)

### 4.11.1 Az elülső panel eltávolítása

1. Emelje fel elől a készüléket.
2. Távolítsa el az aljáról csavarokat (1).

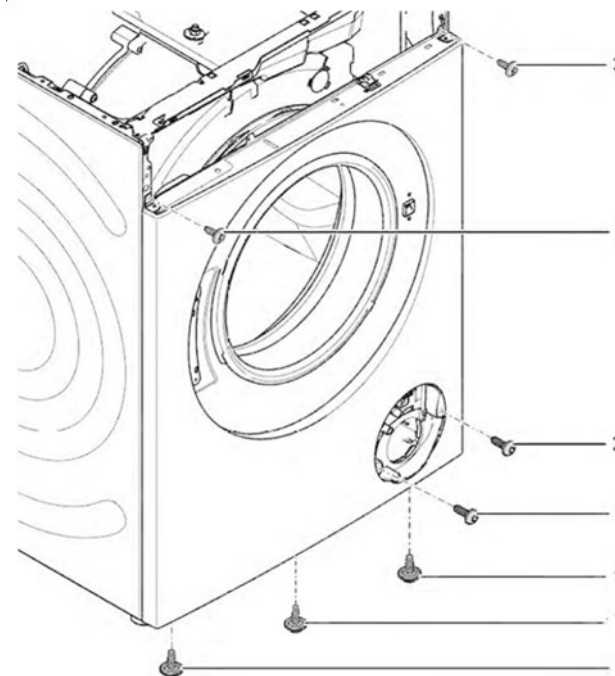

3. Engedje le a készüléket.

4. Távolítsa el a csavarokat az elejéről, haladjon alulról felfelé (2, 3).

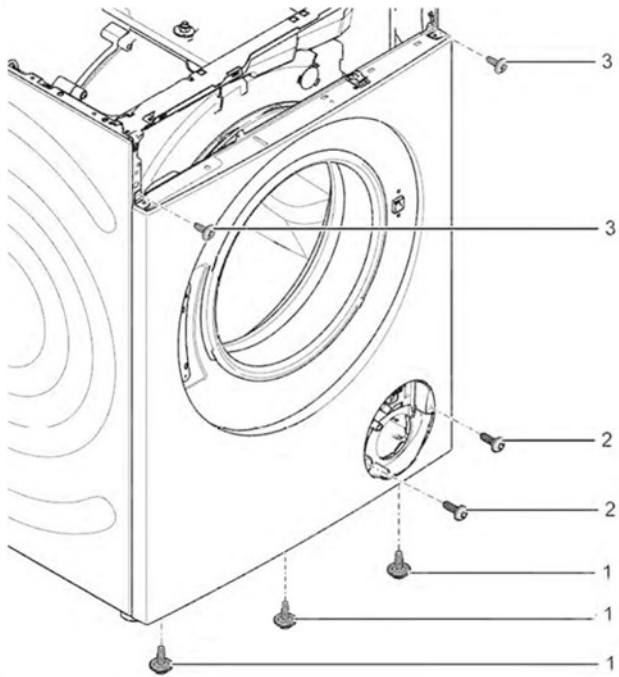

5. Távolítsa el az elülső panelt.

### 4.11.2 Az elülső panel telepítése

- ▶ Az elhelyezést fordított sorrendben végezze.

# Consigli di riparazione - Lavatrice

## **Utilizzo del documento** ..... 234

1.1	Avvertenze importanti	234
1.1.1	Scopo	234
1.2	Spiegazione dei simboli	234
1.2.1	Livelli di pericolo	234
1.2.2	Simboli di pericolo	234
1.2.3	Struttura degli avvertimenti	235
1.2.4	Simboli generici	235

## **Sicurezza** ..... 236

2.1	Note generali sulla sicurezza	236
2.1.1	Tutti gli elettrodomestici	236

## **Strumenti e ausili** ..... 237

## **Riparazione**..... 238

4.1	Sostituzione del piano di lavoro	238
4.1.1	Smontaggio del piano di lavoro	238
4.1.2	Montaggio del piano di lavoro	238
4.2	Sostituzione del cassetto del detersivo	239
4.2.1	Smontaggio del cassetto del detersivo	239
4.2.2	Montaggio del cassetto del detersivo	239
4.3	Sostituzione della maniglia del cassetto del detersivo	240
4.3.1	Smontaggio della maniglia del cassetto del detersivo	240
4.3.2	Montaggio della maniglia del cassetto del detersivo	240
4.4	Sostituzione del pannello comandi	241
4.4.1	Smontaggio del pannello comandi	241
4.4.2	Montaggio del pannello comandi	242
4.5	Sostituzione dell'oblò	243
4.5.1	Smontaggio dell'oblò	243
4.5.2	Montaggio dell'oblò	243
4.6	Sostituzione dei componenti dell'oblò	244
4.6.1	Smontaggio dei componenti dell'oblò	244
4.6.2	Montaggio dei componenti dell'oblò	244
4.7	Sostituzione della copertura della pompa	245
4.7.1	Smontaggio della copertura della pompa	245
4.7.2	Montaggio della copertura della pompa	245

4.8	Sostituzione della guarnizione dell'oblò	246
4.8.1	Rimozione della guarnizione dell'oblò	246
4.8.2	Installazione della guarnizione dell'oblò	246
4.9	Sostituzione del blocco porta	247
4.9.1	Smontaggio del blocco porta	247
4.9.2	Montaggio del blocco porta	248
4.10	Sostituzione della luce del cestello	249
4.10.1	Smontaggio della luce del cestello	249
4.10.2	Montaggio della luce del cestello	249
4.11	Sostituzione del pannello frontale	250
4.11.1	Smontaggio del pannello frontale	250
4.11.2	Montaggio del pannello frontale	251

# **i** Utilizzo del documento

## 1.1 Avvertenze importanti

### 1.1.1 Scopo

Queste istruzioni di riparazione spiegano ai clienti come riparare da soli gli elettrodomestici in conformità alle regole sull'Ecodesign vigenti (al 03/2021).

Contengono informazioni sulla sostituzione di pezzi di ricambio specifici e sulle avvertenze e i rischi correlati.

In caso di domande, contattare l'assistenza tecnica. Il mancato rispetto di tali istruzioni da parte dei clienti ci esonera da qualsiasi responsabilità.

## 1.2 Spiegazione dei simboli

### 1.2.1 Livelli di pericolo

I livelli di avvertimento corrispondono a un simbolo accompagnato da una parola di allerta. La parola di allerta identifica il livello di pericolo.





Livello di avvertimento	Significato
	Ignorare questo messaggio di avvertimento comporta rischio di morte o ferite gravi.
	Ignorare questo messaggio di avvertimento può comportare rischio di morte o ferite gravi.
	Ignorare questo messaggio di avvertimento può comportare ferite di minore gravità.
	Ignorare questo messaggio di avvertimento può comportare danni materiali.

Tabella 1: Livelli di pericolo

### 1.2.2 Simboli di pericolo

I simboli di pericolo sono illustrazioni che specificano la tipologia di rischio.

Nella presente documentazione vengono utilizzati i seguenti simboli di pericolo:

Simbolo di pericolo	Significato
	Messaggio di avvertimento generico
	Pericolo di scossa elettrica
	Pericolo di esplosione
	Rischio di ferite da taglio

## i Utilizzo del documento





Simbolo di pericolo	Significato
	Pericolo di schiacciamento
	Pericolo derivante da superfici calde
	Pericolo derivante da forti campi magnetici
	Pericolo derivante da radiazioni non ionizzanti

Tabella 2: Simboli di pericolo

### 1.2.3 Struttura degli avvertimenti

Gli avvertimenti presenti in questo manuale hanno una forma e una struttura standardizzati.

	<p><b>PERICOLO</b></p> <p><b>Tipo e origine del pericolo!</b> Possibili conseguenze in caso di pericolo/avvertimento ignorato.</p> <ul style="list-style-type: none"> <li>▸ Misure e divieti volti a prevenire il pericolo.</li> </ul>
--	--

L'esempio seguente mostra un avvertimento con rischio di folgorazione dovuto a componenti sotto tensione. È riportata la misura di precauzione per evitare il pericolo.

	<p><b>PERICOLO</b></p> <p><b>Rischio di scossa elettrica dovuto a componenti sotto tensione!</b> Morte per folgorazione</p> <ul style="list-style-type: none"> <li>▸ Scollegare l'apparecchio dall'alimentazione per almeno 60 secondi prima di iniziare la riparazione.</li> </ul>
--	---

### 1.2.4 Simboli generici

Nel presente manuale vengono utilizzati i seguenti simboli generici:





Simbolo generico	Significato
	Identificazione di un suggerimento speciale (testo e/o grafica)
	Identificazione di un suggerimento semplice (solo testo)
	Identificazione di un link per un video tutorial
	Identificazione degli strumenti necessari
	Identificazione delle condizioni preve necessarie
	Identificazione di una condizione (se ..., allora ...)
	Identificazione di un risultato
[Avvio]	Identificazione di un tasto o di un pulsante
[00123456]	Identificazione di un codice articolo
Stato	Identificazione di un testo/finestra visualizzati (sul display dell'apparecchio)

Tabella 3: Simboli generici

## 2.1 Note generali sulla sicurezza

### 2.1.1 Tutti gli elettrodomestici

#### **Rischio di scosse elettriche dovute a componenti sotto tensione!**

- La riparazione non conforme dei componenti elettrici può causare scosse elettriche!
- Scollegare l'apparecchio dall'alimentazione per almeno 60 secondi prima di iniziare il lavoro.
- Ultimata la riparazione, occorre eseguire un test di sicurezza conforme alla norma VDE 0701 o alle norme specifiche del Paese.

#### **Rischio di lesioni causate da bordi taglienti!**

- Indossare guanti di protezione.

#### **Rischio di schiacciamento dovuto a componenti pesanti e in movimento durante la riparazione, la manutenzione, la ricerca dei guasti e l'assistenza**

- Indossare calzature antinfortunistiche.
- Fissare i componenti pesanti per impedire che cadano.
- Non inserire parti del corpo nei componenti in movimento.







#### **Rischio per il funzionamento o la sicurezza dell'apparecchio!**

- Utilizzare solo ricambi originali.

#### **Rischio di danneggiamento di componenti sensibili a carica elettrostatica (ESD)!**

- Non toccare i moduli, inclusi i collegamenti e le piste conduttive.

## Strumenti e ausili

Designazione	Dettagli	Immagini
Strumento ausiliario [15000155]	Utensile per allentare i componenti in plastica	
Cacciavite Torx T20 con foro [00340764]	100 mm, per viti con perno di sicurezza	
Chiave dinamometrica [15000441]	Chiave dinamometrica 20 - 100 Nm	
Cacciavite con punta piatta [00340854]	Lama 3,5 mm x 0,6 mm x 100 mm, isolamento di protezione 1000 V AC	
Cacciavite con punta piatta [00340855]	Lama 5,5 mm x 1,0 mm x 125 mm, isolamento di protezione 1000 V AC	
Pinze a becco tondo, struttura angolare [00341269]	Lunghezza 200 mm	
Pinze per taglio laterale [00342182]	Lunghezza: 200 mm	



Designazione	Dettagli	Immagini
Chiave combinata [00340811]	Dimensione della chiave 10°mm, M6	
Combination wrench [00340814]	Dimensione della chiave 13°mm, M8	
Chiave combinata [00340817]	Dimensione della chiave 17 mm, M10	
Chiave combinata [15000459]	Dimensione della chiave 16°mm, M10	

## 4.1 Sostituzione del piano di lavoro

### Attrezzi speciali:

-  Punta Torx TX20 forata Lunghezza 152 mm, lunghezza utile [00341272]  
124 mm, chiave esagonale da 1/4"  
(6,35 mm), per viti con perno di sicu-  
rezza

### Prerequisiti:

-  L'apparecchio è scollegato dalla rete elettrica.
-  L'apparecchio è scollegato dalla rete idrica.

### 4.1.1 Smontaggio del piano di lavoro

- ▶ 1. Rimuovere le viti (1).
- 2. Far scorrere il piano di lavoro verso la parte posteriore dell'apparecchio (2).
- 3. Smontare il piano di lavoro tirandolo verso l'alto (3).

### 4.1.2 Montaggio del piano di lavoro



Osservare l'installazione del cavo. Il cavo potrebbe essere incastrato.

- ▶ Per il montaggio, seguire la procedura sopra descritta in senso opposto.

## 4.2 Sostituzione del cassetto del detersivo

### Prerequisiti:

- ✓ L'apparecchio è scollegato dalla rete elettrica.
- ✓ L'apparecchio è scollegato dalla rete idrica.

### 4.2.1 Smontaggio del cassetto del detersivo

1. Estrarre il cassetto del detersivo.
2. 1. Premere sulla linguetta (1).  
2. Rimuovere il cassetto del detersivo (2).

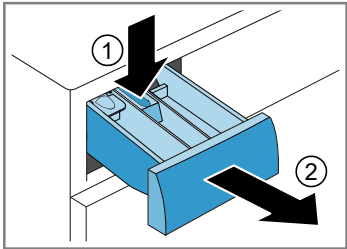

### 4.2.2 Montaggio del cassetto del detersivo

- ▶ Per il montaggio, seguire la procedura sopra descritta in senso opposto.

## 4.3 Sostituzione della maniglia del cassetto del detersivo

### Prerequisiti:

- ✓ L'apparecchio è scollegato dalla rete elettrica.
- ✓ L'apparecchio è scollegato dalla rete idrica.
- ✓ [Il cassetto del detersivo è stato rimosso.](#)→239

### 4.3.1 Smontaggio della maniglia del cassetto del detersivo

1. Sganciare gli elementi di blocco.

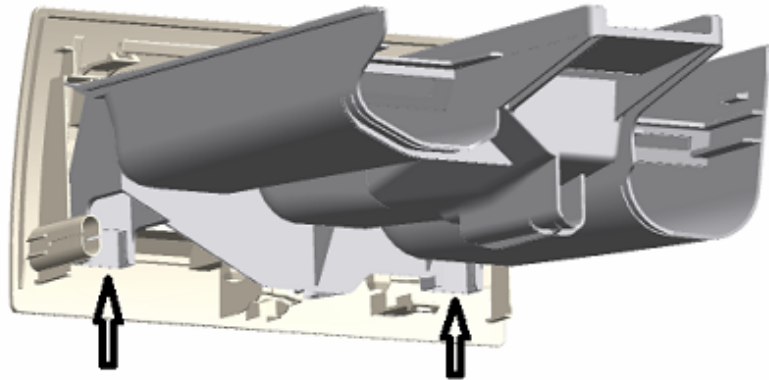

2. Rimuovere la maniglia del cassetto del detersivo.

### 4.3.2 Montaggio della maniglia del cassetto del detersivo

- ▶ Per il montaggio, seguire la procedura sopra descritta in senso opposto.

## 4.4 Sostituzione del pannello comandi

In qualità di società costruttrice, siamo tenuti a fornire ai consumatori un pannello comandi di ricambio incluse le istruzioni di riparazione in conformità al Regolamento (UE) 2019/2023. Tuttavia, desideriamo puntualizzare che, in seguito alla sostituzione del pannello comandi, un elettricista qualificato dovrà eseguire un test di sicurezza elettrotecnica prima di mettere in funzione l'apparecchio. La qualifica di tale incaricato deve essere verificata in conformità alle leggi, alle normative e alle disposizioni specifiche del Paese.

	<b>PERICOLO</b>
	<p><b>Rischio di scosse elettriche dovute a componenti sotto tensione!</b> Pericolo di morte dovuto a scosse elettriche in caso di riparazione non conforme</p> <ul style="list-style-type: none"> <li>▶ Le parti elettriche devono essere riparate da elettricisti qualificati.</li> <li>▶ Ultimata la riparazione, occorre eseguire un test di sicurezza conforme alla norma VDE 0701 o alle norme specifiche del Paese.</li> </ul>

	<b>AVVERTENZA</b>
	<p><b>Gli apparecchi inclinati possono scivolare!</b> Fratture / lesioni da schiacciamento</p> <ul style="list-style-type: none"> <li>▶ Fissare gli apparecchi in modo che non scivolino.</li> </ul>

	<b>ATTENZIONE</b>
	<p><b>Alloggiamento con spigoli vivi!</b> Ferite da taglio</p> <ul style="list-style-type: none"> <li>▶ Indossare guanti di protezione.</li> </ul>

	<b>ATTENZIONE</b>
	<p><b>Rischio di caduta di componenti a causa di viti allentate!</b> Lesioni provocate dalla caduta di componenti.</p> <ul style="list-style-type: none"> <li>▶ Fissare i componenti in modo che non cadano.</li> </ul>

	<b>ATTENZIONE!</b>
	<p><b>Rischio di caduta di componenti a causa di viti allentate!</b> Danni a altre parti dell'apparecchio o all'abitazione del cliente, ad es. parte inferiore.</p> <ul style="list-style-type: none"> <li>▶ Fissare i componenti in modo che non cadano.</li> </ul>

### Prerequisiti:

- ✓ L'apparecchio è scollegato dalla rete elettrica.
- ✓ L'apparecchio è scollegato dalla rete idrica.
- ✓ [Il piano di lavoro è stato smontato. →238](#)
- ✓ [Il cassetto del detersivo è stato rimosso. →239](#)

### 4.4.1 Smontaggio del pannello comandi

1. Rimuovere le viti (1).
2. Sganciare gli elementi di blocco (2, 3).

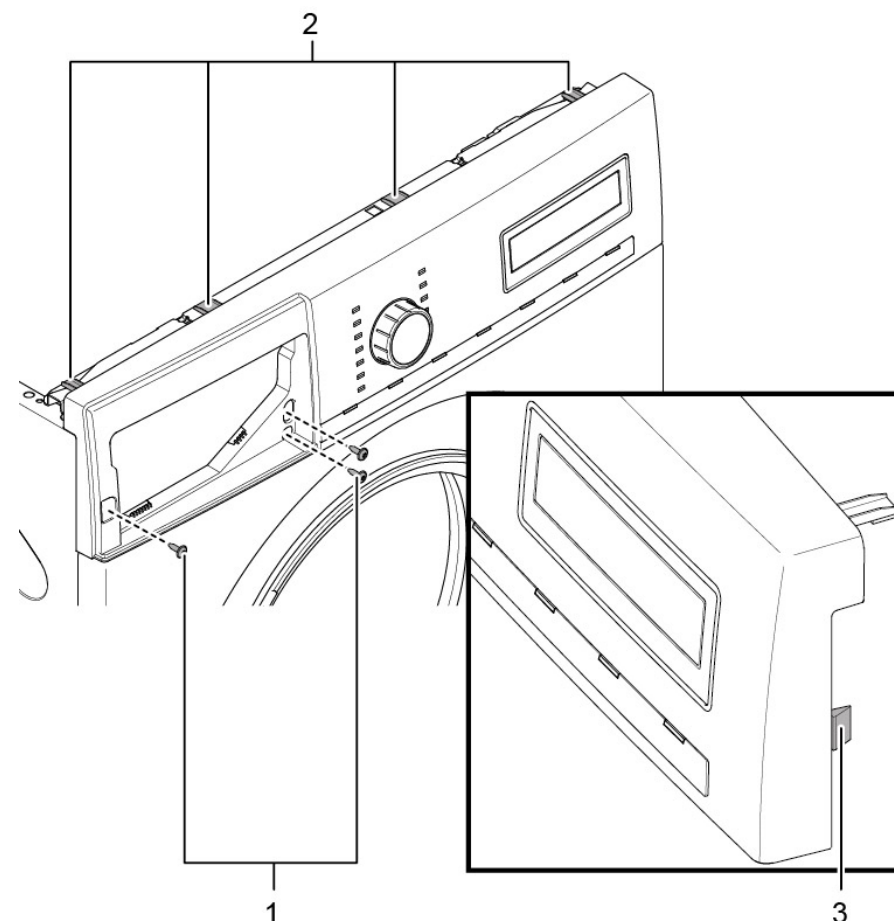

2. Allentare il contatto della spina dell'unità di controllo.
3. Smontare il pannello comandi.

### 4.4.2 Montaggio del pannello comandi





Osservare l'installazione del cavo. Il cavo potrebbe essere incastrato.

- ▶ Per il montaggio, seguire la procedura sopra descritta in senso opposto.

## 4.5 Sostituzione dell'oblò

	<b>ATTENZIONE</b> <b>Zona della cerniera aperta!</b> Rischio di schiacciamento delle dita / di rimanere incastrati <ul style="list-style-type: none"><li>▶ Non inserire le dita nella zona della cerniera.</li><li>▶ Indossare guanti di protezione.</li></ul>
--	--

	<b>ATTENZIONE</b> <b>Rischio di caduta di componenti a causa di viti allentate!</b> Lesioni provocate dalla caduta di componenti. <ul style="list-style-type: none"><li>▶ Fissare i componenti in modo che non cadano.</li></ul>
--	--

	<b>ATTENZIONE!</b> <b>Rischio di caduta di componenti a causa di viti allentate!</b> Danni a altre parti dell'apparecchio o all'abitazione del cliente, ad es. parte inferiore. <ul style="list-style-type: none"><li>▶ Fissare i componenti in modo che non cadano.</li></ul>
--	--

### Prerequisiti:

- ✔ L'apparecchio è scollegato dalla rete elettrica.
- ✔ L'apparecchio è scollegato dalla rete idrica.
- ✔ L'oblò è aperto.

### 4.5.1 Smontaggio dell'oblò

1. Togliere le viti (1).

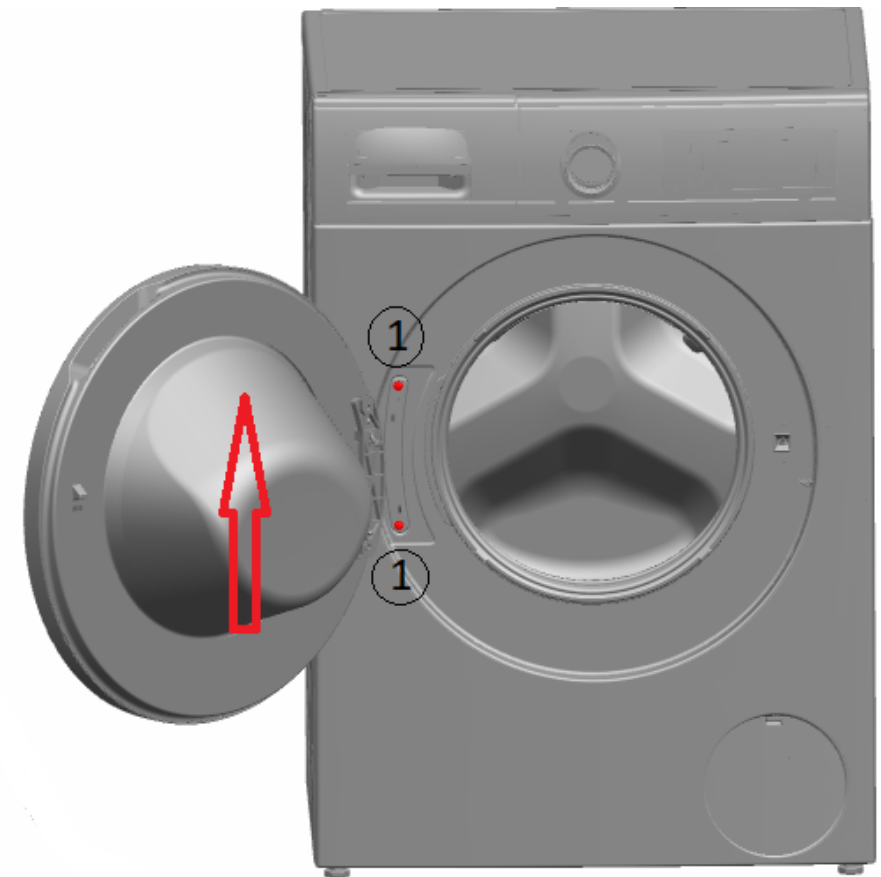



2. Smontare l'oblò sollevandolo.

### 4.5.2 Montaggio dell'oblò

- ▶ Per il montaggio, seguire la procedura sopra descritta in senso opposto.

## 4.6 Sostituzione dei componenti dell'oblò

	<b>⚠ AVVERTENZA</b>
	<b>Componenti pesanti e in movimento!</b> Rischio di schiacciamento durante la riparazione, la manutenzione, la ricerca dei guasti e l'assistenza <ul style="list-style-type: none"><li>▶ Indossare calzature antinfortunistiche.</li><li>▶ Fissare i componenti pesanti per impedire che cadano.</li><li>▶ Non inserire parti del corpo nei componenti in movimento.</li></ul>

	<b>⚠ ATTENZIONE</b>
	<b>Zona della cerniera aperta!</b> Rischio di schiacciamento delle dita / di rimanere incastrati <ul style="list-style-type: none"><li>▶ Non inserire le dita nella zona della cerniera.</li><li>▶ Indossare guanti di protezione.</li></ul>

### Prerequisiti:

- ✓ L'apparecchio è scollegato dalla rete elettrica.
- ✓ L'apparecchio è scollegato dalla rete idrica.
- ✓ [L'oblò è stato smontato. → 243](#)

### 4.6.1 Smontaggio dei componenti dell'oblò

- ▶ Smontare l'oblò procedendo dall'esterno verso l'interno.

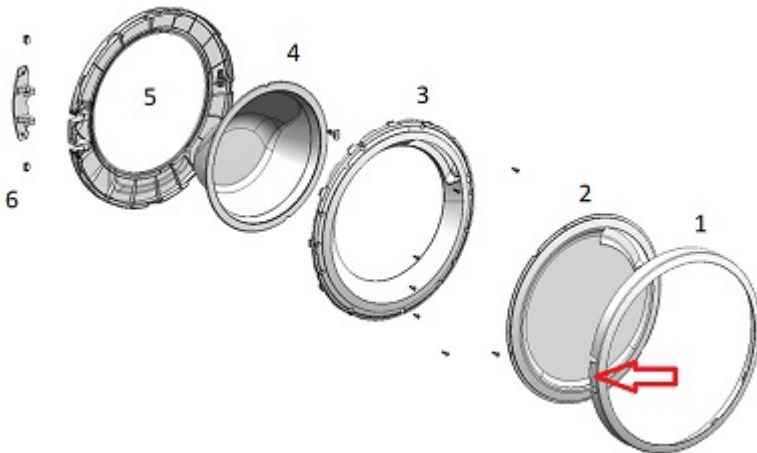

### 4.6.2 Montaggio dei componenti dell'oblò

- ▶ Per il montaggio, seguire la procedura sopra descritta in senso opposto.

## 4.7 Sostituzione della copertura della pompa

### Prerequisiti:

- ✓ L'apparecchio è scollegato dalla rete elettrica.
- ✓ L'apparecchio è scollegato dalla rete idrica.

### 4.7.1 Smontaggio della copertura della pompa

1. Aprire la copertura della pompa.

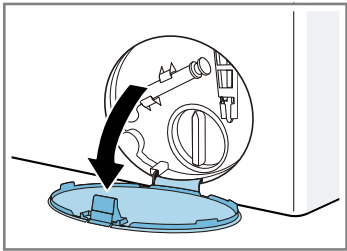

2. Togliere la copertura della pompa.

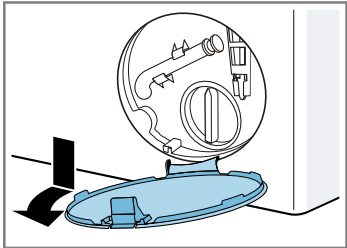

### 4.7.2 Montaggio della copertura della pompa

- ▶ Per il montaggio, seguire la procedura sopra descritta in senso opposto.

## 4.8 Sostituzione della guarnizione dell'oblò

	<b>ATTENZIONE</b> <b>Alloggiamento con spigoli vivi!</b> Ferite da taglio ▶ Indossare guanti di protezione.
--	--

	<b>ATTENZIONE</b> <b>Rischio di caduta di componenti a causa di viti allentate!</b> Lesioni provocate dalla caduta di componenti. ▶ Fissare i componenti in modo che non cadano.
--	---

	<b>ATTENZIONE!</b> <b>Rischio di caduta di componenti a causa di viti allentate!</b> Danni a altre parti dell'apparecchio o all'abitazione del cliente, ad es. parte inferiore. ▶ Fissare i componenti in modo che non cadano.
--	---

### Prerequisiti:

- ✓ L'apparecchio è scollegato dalla rete elettrica.
- ✓ L'apparecchio è scollegato dalla rete idrica.
- ✓ L'apparecchio è liberamente accessibile.
- ✓ [Il piano di lavoro è stato smontato.→238](#)
- ✓ [Il cassetto del detersivo è stato rimosso.→239](#)
- ✓ [Il pannello comandi è stato smontato.→241](#)
- ✓ [L'oblò è stato smontato.→243](#)
- ✓ [La copertura della pompa è stata rimossa.→245](#)
- ✓ [Il pannello frontale è stato smontato.→250](#)
- ✓ [La luce del cestello è stata rimossa \(opzionale\).→249](#)

### 4.8.1 Rimozione della guarnizione dell'oblò

1. Allentare la connessione di tutti i tubi flessibili.

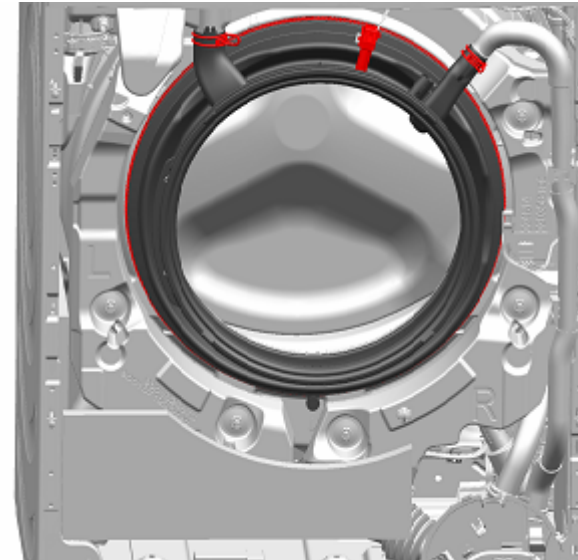

2. Rimuovere la guarnizione dell'oblò.

### 4.8.2 Installazione della guarnizione dell'oblò

	<b>AVVERTENZA</b> <b>Rischio di caduta di componenti a causa di installazione errata!</b> Lesioni o danni all'apparecchio. ▶ Serrare l'anello di bloccaggio della guarnizione dello sportello con una coppia di 3,4 Nm.
---	--

- ▶ Per il montaggio, seguire la procedura sopra descritta in senso opposto.

## 4.9 Sostituzione del blocco porta

In qualità di società costruttrice, siamo tenuti a fornire ai consumatori una chiusura di sicurezza di ricambio incluse le istruzioni di riparazione in conformità al Regolamento (UE) 2019/2023. Tuttavia, desideriamo puntualizzare che, in seguito alla sostituzione della chiusura di sicurezza, un elettricista qualificato dovrà eseguire un test di sicurezza elettrotecnica prima di mettere in funzione l'apparecchio. La qualifica di tale incaricato deve essere verificata in conformità alle leggi, alle normative e alle disposizioni specifiche del Paese.

	<b>⚠ PERICOLO</b>
	<p><b>Rischio di scosse elettriche dovute a componenti sotto tensione!</b> Pericolo di morte dovuto a scosse elettriche in caso di riparazione non conforme</p> <ul style="list-style-type: none"> <li>▶ Le parti elettriche devono essere riparate da elettricisti qualificati.</li> <li>▶ Ultimata la riparazione, occorre eseguire un test di sicurezza conforme alla norma VDE 0701 o alle norme specifiche del Paese.</li> </ul>

	<b>⚠ AVVERTENZA</b>
	<p><b>Gli apparecchi inclinati possono scivolare!</b> Fratture / lesioni da schiacciamento</p> <ul style="list-style-type: none"> <li>▶ Fissare gli apparecchi in modo che non scivolino.</li> </ul>

	<b>⚠ ATTENZIONE</b>
	<p><b>Alloggiamento con spigoli vivi!</b> Ferite da taglio</p> <ul style="list-style-type: none"> <li>▶ Indossare guanti di protezione.</li> </ul>

	<b>⚠ ATTENZIONE</b>
	<p><b>Rischio di caduta di componenti a causa di viti allentate!</b> Lesioni provocate dalla caduta di componenti.</p> <ul style="list-style-type: none"> <li>▶ Fissare i componenti in modo che non cadano.</li> </ul>

	<b>ATTENZIONE!</b>
	<p><b>Rischio di caduta di componenti a causa di viti allentate!</b> Danni a altre parti dell'apparecchio o all'abitazione del cliente, ad es. parte inferiore.</p> <ul style="list-style-type: none"> <li>▶ Fissare i componenti in modo che non cadano.</li> </ul>

### Prerequisiti:

- ✓ L'apparecchio è scollegato dalla rete elettrica.
- ✓ L'apparecchio è scollegato dalla rete idrica.
- ✓ L'apparecchio è liberamente accessibile.
- ✓ [Il piano di lavoro è stato smontato.→238](#)
- ✓ [Il cassetto del detersivo è stato rimosso.→239](#)
- ✓ [Il pannello comandi è stato smontato.→241](#)
- ✓ [L'oblò è stato smontato.→243](#)
- ✓ L'anello a molla è stato smontato.
- ✓ [La guarnizione dell'oblò è stata smontata.→246](#)
- ✓ [La copertura della pompa è stata rimossa.→245](#)
- ✓ [Il pannello frontale è stato smontato.→250](#)

### 4.9.1 Smontaggio del blocco porta

1. Scollegare la spina del blocco porta.
2. Smontare il blocco porta.



3. Rimuovere il blocco porta.

### 4.9.2 Montaggio del blocco porta

Il blocco porta deve trovarsi in posizione corretta per garantire l'apertura di emergenza dell'oblò dell'apparecchio.

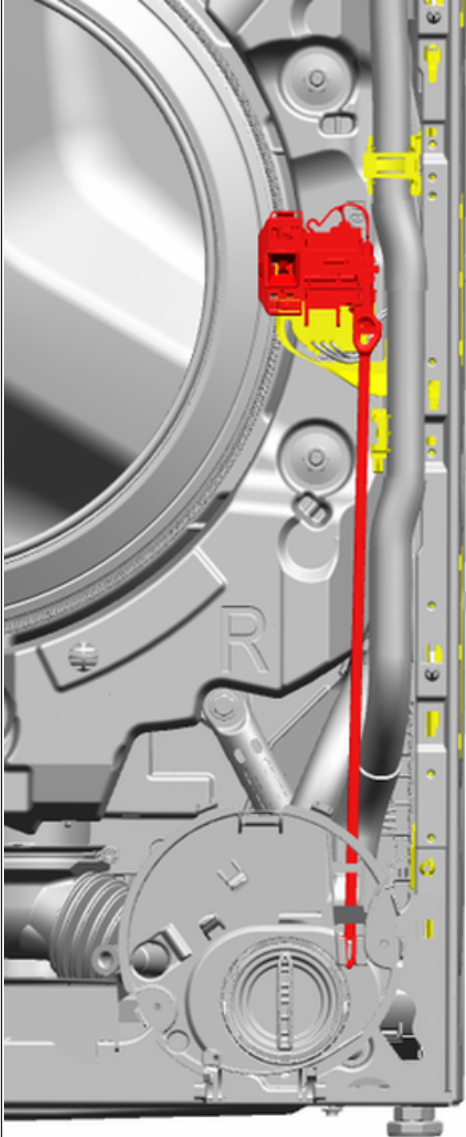

- ▶ Per il montaggio, seguire la procedura sopra descritta in senso opposto.

## 4.10 Sostituzione della luce del cestello



### AVVERTENZA

**Gli apparecchi inclinati possono scivolare!**

Fratture / lesioni da schiacciamento

- ▶ Fissare gli apparecchi in modo che non scivolino.



### ATTENZIONE

**Alloggiamento con spigoli vivi!**

Ferite da taglio

- ▶ Indossare guanti di protezione.



### ATTENZIONE

**Rischio di caduta di componenti a causa di viti allentate!**

Lesioni provocate dalla caduta di componenti.

- ▶ Fissare i componenti in modo che non cadano.



### ATTENZIONE!

**Rischio di caduta di componenti a causa di viti allentate!**

Danni a altre parti dell'apparecchio o all'abitazione del cliente, ad es. parte inferiore.

- ▶ Fissare i componenti in modo che non cadano.

### Prerequisiti:

- ✓ L'apparecchio è scollegato dalla rete elettrica.
- ✓ L'apparecchio è scollegato dalla rete idrica.
- ✓ L'apparecchio è liberamente accessibile.
- ✓ [Il piano di lavoro è stato smontato.→238](#)
- ✓ [Il cassetto del detersivo è stato rimosso.→239](#)
- ✓ [Il pannello comandi è stato smontato.→241](#)

## 4.10.1 Smontaggio della luce del cestello

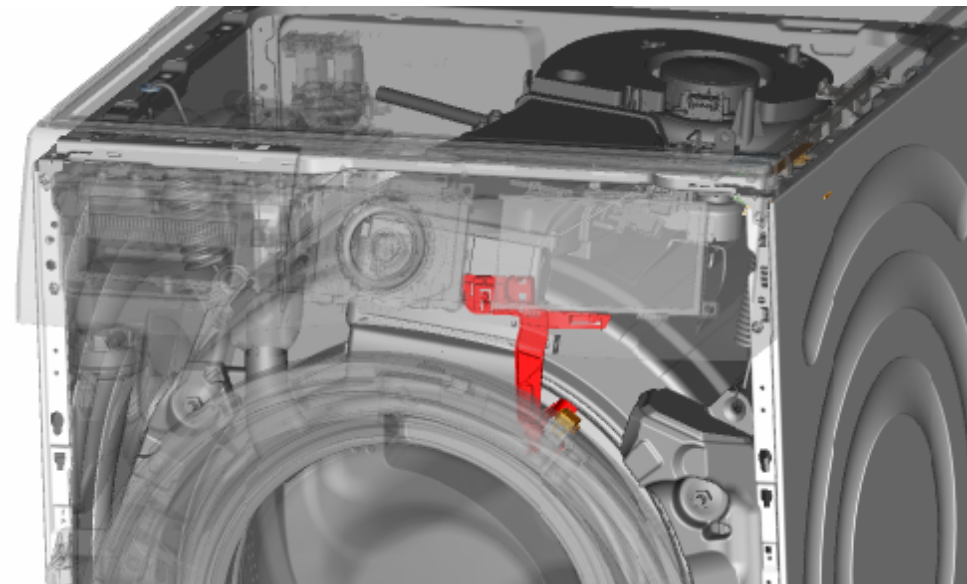

1. Estrarre dall'apparecchio il supporto della luce del cestello.
2. Staccare i collegamenti elettrici.
3. Rimuovere la luce del cestello dal suo supporto.

## 4.10.2 Montaggio della luce del cestello



Osservare l'installazione del cavo. Il cavo potrebbe essere incastrato.

- ▶ Per il montaggio, seguire la procedura sopra descritta in senso opposto.

## 4.11 Sostituzione del pannello frontale



### AVVERTENZA

**Gli apparecchi inclinati possono scivolare!**

Fratture / lesioni da schiacciamento

- ▶ Fissare gli apparecchi in modo che non scivolino.



### ATTENZIONE

**Alloggiamento con spigoli vivi!**

Ferite da taglio

- ▶ Indossare guanti di protezione.



### ATTENZIONE

**Rischio di caduta di componenti a causa di viti allentate!**

Lesioni provocate dalla caduta di componenti.

- ▶ Fissare i componenti in modo che non cadano.



### ATTENZIONE!

**Rischio di caduta di componenti a causa di viti allentate!**

Danni a altre parti dell'apparecchio o all'abitazione del cliente, ad es. parte inferiore.

- ▶ Fissare i componenti in modo che non cadano.

### Prerequisiti:

- ✓ L'apparecchio è scollegato dalla rete elettrica.
- ✓ L'apparecchio è scollegato dalla rete idrica.
- ✓ L'apparecchio è liberamente accessibile.
- ✓ [Il piano di lavoro è stato smontato.→238](#)
- ✓ [Il cassetto del detersivo è stato rimosso.→239](#)
- ✓ [Il pannello comandi è stato smontato.→241](#)
- ✓ [L'oblò è stato smontato.→243](#)
- ✓ [La copertura della pompa è stata rimossa.→245](#)
- ✓ L'anello a molla è stato smontato.
- ✓ La guarnizione dell'oblò è stata smontata nella parte frontale.
- ✓ [La luce del cestello è stata rimossa \(opzionale\).→249](#)

### 4.11.1 Smontaggio del pannello frontale

1. Sollevare l'apparecchio nella parte frontale.
2. Rimuovere le viti nella parte inferiore (1).

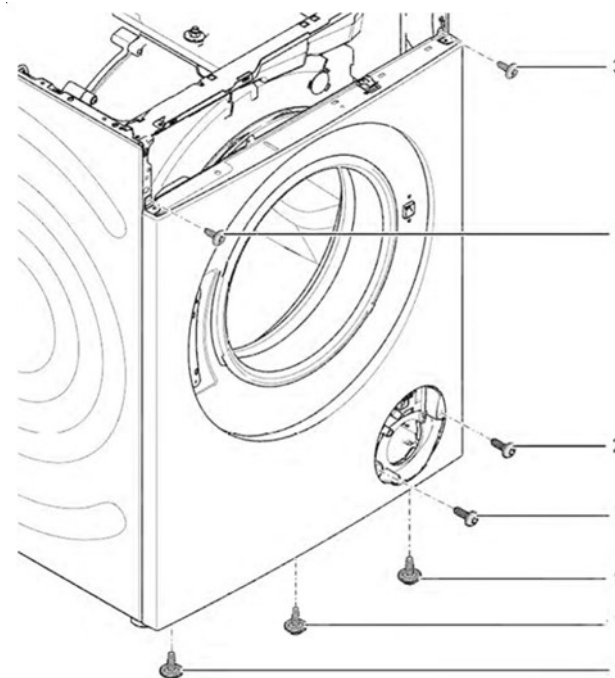

3. Abbassare l'apparecchio.

4. Rimuovere le viti nella parte frontale procedendo dal basso verso l'alto (2, 3).

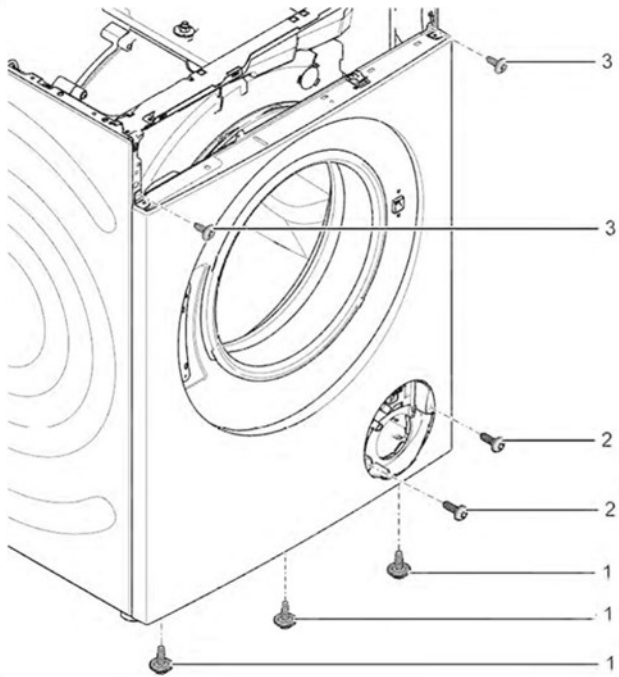

5. Rimuovere il pannello frontale.

### 4.11.2 Montaggio del pannello frontale

- ▶ Per il montaggio, seguire la procedura sopra descritta in senso opposto.

# Informācija par remontu - Veļas mazgājamā mašīna

## Par šo dokumentu..... 253

1.1	Būtiska informācija .....	253
1.1.1	Mērķis .....	253
1.2	Simbolu skaidrojums.....	253
1.2.1	Bīstamības līmeņi .....	253
1.2.2	Bīstamības simboli .....	253
1.2.3	Brīdinājumu struktūra .....	254
1.2.4	Vispārīgie simboli.....	254

## Drošība..... 255

2.1	Vispārējie drošības norādījumi .....	255
2.1.1	Visām mājsaimniecības ierīcēm .....	255

## Piederumi un palīgļīdzekļi..... 256

## Remonts .....

4.1	Darbvirsmas nomaiņa .....	257
4.1.1	Darbvirsmas noņemšana.....	257
4.1.2	Darbvirsmas uzstādīšana .....	257
4.2	Mazgāšanas līdzekļa atvilktnes nomaiņa.....	258
4.2.1	Mazgāšanas līdzekļa atvilktnes izņemšana.....	258
4.2.2	Mazgāšanas līdzekļa atvilktnes uzstādīšana.....	258
4.3	Mazgāšanas līdzekļa atvilktnes roktura nomaiņa .....	259
4.3.1	Mazgāšanas līdzekļa atvilktnes roktura izņemšana .....	259
4.3.2	Mazgāšanas līdzekļa atvilktnes roktura uzstādīšana .....	259
4.4	Fascijas paneļa nomaiņa .....	260
4.4.1	Fascijas paneļa noņemšana .....	260
4.4.2	Fascijas paneļa uzstādīšana.....	261
4.5	Durtiņu nomaiņa .....	262
4.5.1	Durtiņu noņemšana.....	262
4.5.2	Durtiņu uzstādīšana .....	262
4.6	Durtiņu detaļu nomaiņa .....	263
4.6.1	Durtiņu daļu noņemšana.....	263
4.6.2	Durtiņu daļu uzstādīšana .....	263
4.7	Sūkņa vāka nomaiņa .....	264
4.7.1	Sūkņa vāka noņemšana .....	264
4.7.2	Sūkņa vāka uzstādīšana.....	264

4.8	Durtiņu blīves nomaiņa.....	265
4.8.1	Durtiņu blīves noņemšana.....	265
4.8.2	Durtiņu blīvējuma uzstādīšana .....	265
4.9	Durtiņu slēga nomaiņa.....	266
4.9.1	Durtiņu slēga noņemšana .....	266
4.9.2	Durtiņu slēga uzstādīšana.....	267
4.10	Bunduļa lampiņas nomaiņa.....	268
4.10.1	Bunduļa lampiņas izņemšana.....	268
4.10.2	Bunduļa lampiņas uzstādīšana .....	268
4.11	Priekšējā paneļa nomaiņa .....	269
4.11.1	Priekšējā paneļa noņemšana .....	269
4.11.2	Priekšējā paneļa uzstādīšana.....	270

# **i** Par šo dokumentu

## 1.1 Būtiska informācija

### 1.1.1 Mērķis

Šie labošanas ieteikumi ir paredzēti patērētājam, lai patstāvīgi labotu ierīces, saskaņā ar piemērojamo Ekodizaina regulu (sākot no 03.2021.).





Ir sniegta informācija, kā nomainīt noteiktas rezerves daļas, un brīdinājumi, kā arī ir aprakstīti riski.

Ja ir jautājumi, sazinieties ar mūsu klientu apkalpošanas dienestu. Mēs atbildam par zaudējumiem tikai tad, ja šie labošanas ieteikumi ir pienācīgi ievēroti.

## 1.2 Simbolu skaidrojums

### 1.2.1 Bīstamības līmeņi

Brīdinājuma līmeņus veido simbols un signālvārds. Signālvārds apzīmē bīstamības pakāpi.





Brīdinājuma līmenis	Nozīme
 <b>BĪSTAMI</b>	Brīdinājuma paziņojuma neievērošanas rezultātā iestāsies nāve vai radīsies smagas traumas.
 <b>BRĪDINĀJUMS</b>	Brīdinājuma paziņojuma neievērošanas rezultātā var iestāties nāve vai rasties smagas traumas.
 <b>ESJET PIESARDŽĪGI</b>	Brīdinājuma paziņojuma neievērošanas rezultātā var rasties nelielas traumas.
 <b>UZMANĪBU!</b>	Brīdinājuma paziņojuma neievērošanas rezultātā var rasties kaitējums īpašumam.

Tabula 1: Bīstamības līmeņi



### 1.2.2 Bīstamības simboli

Bīstamības simboli ir simboliski apzīmējumi, kas sniedz norādes par bīstamības veidu.

Šajā dokumentā ir izmantoti šādi bīstamības simboli:

Bīstamības simbols	Nozīme
	Vispārējs brīdinājuma paziņojums
	Elektriskā sprieguma radīts apdraudējums
	Sprādzienbīstamības risks
	Griezumu bīstamība
	Saspiešanas bīstamība

## **i** Par šo dokumentu

Bīstamības simbols	Nozīme
	Karstu virsmu radīta bīstamība
	Spēcīgu magnētisko lauku radīta bīstamība
	Nejonizējoša starojuma radīta bīstamība

Tabula 2: Bīstamības simboli

### 1.2.3 Brīdinājumu struktūra

Šajā dokumentā sniegtajiem brīdinājumiem ir standartizēts noformējums un standartizēta struktūra.



	<p><b>⚠ BĪSTAMI</b></p> <p><b>Bīstamības veids un avots!</b> Iespējamās sekas, kas rodas, neievērojot bīstamības paziņojumu / brīdinājumu.</p> <ul style="list-style-type: none"> <li>▶ Bīstamības novēršanas pasākumi un aizliegumi.</li> </ul>
--	--





Nākamajā piemērā ir parādīts brīdinājums, kas apzīmē elektrotrieciena risku, ko rada spriegumaktīvas detaļas. Ir norādīts bīstamības novēršanas pasākums.

	<p><b>⚠ BĪSTAMI</b></p> <p><b>Elektrotrieciena risks, ko rada spriegumaktīvas detaļas!</b> Nāvējošs elektrotrieciens</p> <ul style="list-style-type: none"> <li>▶ Atvienojiet iekārtas no strāvas padeves vismaz 60 sekundes pirms labošanas sākšanas.</li> </ul>
--	---

### 1.2.4 Vispārīgie simboli

Šajā dokumentā ir izmantoti šādi vispārīgie simboli:

Visp. simbols	Nozīme
	Īpašu ieteikumu apzīmējums (teksts un/ vai grafika)
	Vienkāršu ieteikumu apzīmējums (tikai teksts)

Visp. simbols	Nozīme
	Video pamācības saites apzīmējums
	Nepieciešamo rīku apzīmējums
	Nepieciešamo priekšnosacījumu apzīmējums
	Nosacījuma apzīmējums (ja ..., tad ...)
	Rezultāta apzīmējums
[Sākt]	Taustiņa vai pogas apzīmējums
[00123456]	Materiāla numura apzīmējums
Statuss	Attēlotā teksta / loga apzīmējums (iekārtas displejā)

Tabula 3: Vispārīgie simboli

## 2.1 Vispārējie drošības norādījumi

### 2.1.1 Visām mājsaimniecības ierīcēm

#### **Elektrotrieciena risks spriegumaktīvu daļu dēļ!**

- Ja remonts, kas skar elektriskās daļas, ir veikts kļūdaini, pastāv elektrotrieciena risks!
- Ierīcei ir jābūt atvienotai no tīkla vismaz 60 sekundes, pirms sāk darbu.
- Pēc remonta ierīces drošība ir jāpārbauda atbilstīgi noteikumiem VDE 0701 vai valsts noteikumiem.

#### **Savainojumu risks asu malu dēļ!**

- Valkājiet aizsargcimdus.

#### **Saspiešanas risks labošanas, uzturēšanas, traucējumu novēršanas un apkopes laikā, ko rada smagas un kustīgas detaļas**

- Valkājiet aizsargapavus.
- Nostipriniet smagas detaļas, lai tās nenokristu.
- Neievietojiet ķermeņa daļas kustīgās detaļās.







#### **Ierīces drošības / darbības traucējuma risks!**





- Izmantojiet tikai oriģinālās rezerves daļas.

#### **Pret elektrostatisko izlādi jutīgu daļu (ESDS) bojājuma risks!**

- Neaiztieciet moduļus, ieskaitot savienojumus un vadojumu.

## Piederumi un palīglīdzekļi

Apzīmējums	Sīkāka informācija	Attēli
Papildu instruments [15000155]	Instrumenti plastmasas detaļu atvienošanai	
Skrūvgriezis Torx T20 ar urbumu [00340764]	100 mm, skrūvēm ar drošības tapiņu	
Momentatslēga [15000441]	Momentatslēga: 20–100 Nm	
Plakans skrūvgriezis [00340854]	Izmērs: 3,5 mm x 0,6 mm x 100 mm, aizsargizolācija: 1000 V maiņstrāva	
Plakans skrūvgriezis [00340855]	Izmērs: 5,5 mm x 1,0 mm x 125 mm, aizsargizolācija: 1000 V maiņstrāva	
Asknaibles, izliektas [00341269]	Garums: 200 mm	
Sānknaibles [00342182]	Garums: 200 mm	



Apzīmējums	Sīkāka informācija	Attēli
Kombinētā uzgriežņu atslēga [00340811]	Atslēgas platums 10°mm, M6	
Combination wrench [00340814]	Atslēgas platums 13°mm, M8	
Kombinētā uzgriežņu atslēga [00340817]	Atslēgas platums 17 mm, M10	
Kombinētā uzgriežņu atslēga [15000459]	Atslēgas platums 16°mm, M10	

## 4.1 Darbvirsmas nomaiņa

### Speciāli rīki:

-  Torx uzgalis TX20 ar caurumu Garums 152 mm, izmantojamais garums 124 mm, 1/4" sešstūru atslēga (6,35 mm), skrūvēm ar drošības tapīņu [00341272]

### Prasība:

-  Ierīcei ir jābūt atvienotai no strāvas padeves.
-  Ierīcei ir jābūt atvienotai no ūdens padeves.

### 4.1.1 Darbvirsmas noņemšana

- ▶ 1. Izskrūvējiet skrūves (1).
- ▶ 2. Pastumiet darbvirsmu uz ierīces aizmuguri (2).
- ▶ 3. Virziet darbvirsmu augšup (3), lai to noņemtu.

### 4.1.2 Darbvirsmas uzstādīšana

	Ņemiet vērā kabeļu izvietojumu. Kabelis var tikt iespiests.
---	---

- ▶ Uzstādiet apgrieztā kārtībā.

## 4.2 Mazgāšanas līdzekļa atvilktnes nomaiņa

### Prasība:

- ✓ Ierīcei ir jābūt atvienotai no strāvas padeves.
- ✓ Ierīcei ir jābūt atvienotai no ūdens padeves.

### 4.2.1 Mazgāšanas līdzekļa atvilktnes izņemšana

1. Izvelciet mazgāšanas līdzekļa atvilktni.
2. 1. Nospiediet ieliktni lejup (1).  
2. Izņemiet mazgāšanas līdzekļa atvilktni (2).

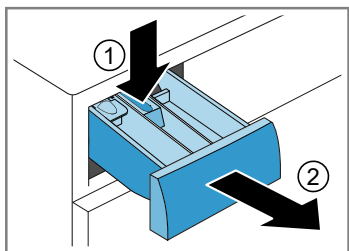

### 4.2.2 Mazgāšanas līdzekļa atvilktnes uzstādīšana

- ▶ Uzstādiet apgrieztā kārtībā.

## 4.3 Mazgāšanas līdzekļa atvilktnes roktura nomainīšana

### Prasība:

- ✓ Ierīcei ir jābūt atvienotai no strāvas padeves.
- ✓ Ierīcei ir jābūt atvienotai no ūdens padeves.
- ✓ [Izņemta mazgāšanas līdzekļa atvilktnē.](#) →258

### 4.3.1 Mazgāšanas līdzekļa atvilktnes roktura izņemšana

1. Atvienojiet stiprinājuma elementus.

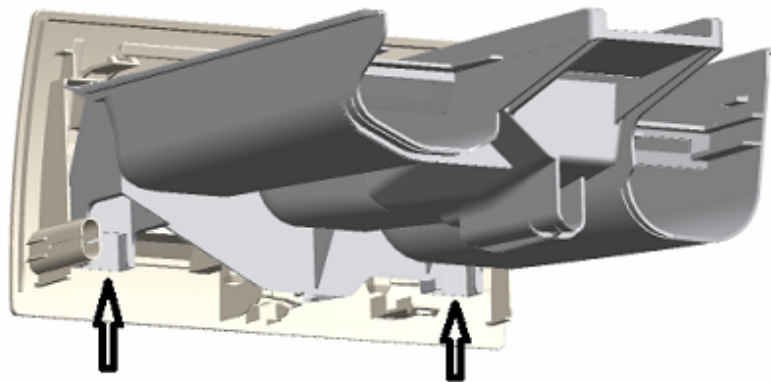

2. Noņemiet mazgāšanas līdzekļa atvilktnes rokturi.

### 4.3.2 Mazgāšanas līdzekļa atvilktnes roktura uzstādīšana

- ▶ Uzstādiet apgrieztā kārtībā.

## 4.4 Fascijas paneļa nomaiņa

Atbilstīgi Regulai (ES) 2019/2023 jums kā ražotājam ir jānodrošina patērētājiem rezerves priekšējā paneļa pārsegs, ieskaitot remonta instrukciju. Tomēr vēlamies norādīt, ka pēc priekšējā paneļa pārsega maiņas kvalificētam elektriķim ir jāpārbauda ierīces elektrodrošība, pirms to sāk izmantot. Elektriķim ir jāapliecina sava kvalifikācija atbilstīgi valsts tiesību aktiem, noteikumiem un prasībām.

	<p style="text-align: center;"><b>⚠ BĪSTAMI</b></p> <p><b>Elektrotrieciena risks spriegumaktīvu daļu dēļ!</b> Dzīvības apdraudējums nepareiza remonta izraisīta elektrotrieciena dēļ</p> <ul style="list-style-type: none"> <li>▶ Elektriskās daļas ir jāremontē kvalificētam elektriķim.</li> <li>▶ Pēc remonta ierīces drošība ir jāpārbauda atbilstīgi noteikumiem VDE 0701 vai valsts noteikumiem.</li> </ul>
	<p style="text-align: center;"><b>⚠ BRĪDINĀJUMS</b></p> <p><b>Sasvērušos ierīču paslīdēšana!</b> Kaulu lūzumi / saspiešanas traumas</p> <ul style="list-style-type: none"> <li>▶ Nostipriniet ierīces, lai tās neslīdētu.</li> </ul>
	<p style="text-align: center;"><b>⚠ ESIET PIESARDŽĪGI</b></p> <p><b>Asas korpusa malas!</b> Griezumu traumas</p> <ul style="list-style-type: none"> <li>▶ Valkājiet aizsargcimdus.</li> </ul>
	<p style="text-align: center;"><b>⚠ ESIET PIESARDŽĪGI</b></p> <p><b>Krītošu detaļu risks, ko izraisa vaļīgas skrūves!</b> Krītošu detaļu izraisītas traumas.</p> <ul style="list-style-type: none"> <li>▶ Nostipriniet detaļu, lai tā nenokristu.</li> </ul>
	<p style="text-align: center;"><b>UZMANĪBU!</b></p> <p><b>Krītošu detaļu risks, ko izraisa vaļīgas skrūves!</b> Citu ierīces detaļu bojājumi vai bojājumi, kas rodas klienta mājās, piem., apakšpuse.</p> <ul style="list-style-type: none"> <li>▶ Nostipriniet detaļu, lai tā nenokristu.</li> </ul>

### Prasība:

- ✓ Ierīcei ir jābūt atvienotai no strāvas padeves.
- ✓ Ierīcei ir jābūt atvienotai no ūdens padeves.

- ✓ [Darbvirsma noņemta.→257](#)
- ✓ [Izņemta mazgāšanas līdzekļa atvilktnē.→258](#)

### 4.4.1 Fascijas paneļa noņemšana

1. 1. Izskrūvējiet skrūves (1).
2. 2. Atvienojiet stiprinājuma elementus (2, 3).

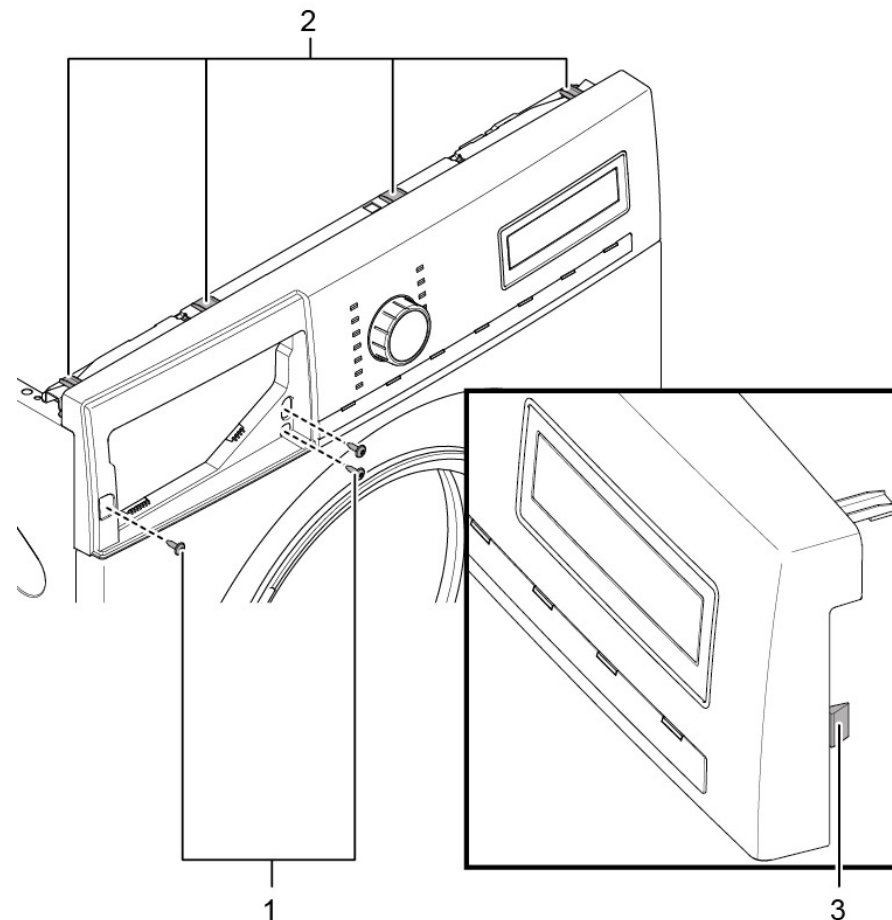

2. 2. Atvienojiet vadības bloka spraudņa savienojumu.
3. 3. Noņemiet fascijas paneli.

## 4.4.2 Fascijas paneļa uzstādīšana



Ņemiet vērā kabeļu izvietojumu. Kabelis var tikt iespiests.

- ▶ Uzstādiet apgrieztā kārtībā.

## 4.5 Durtiņu nomaiņa



### ⚠ ESIET PIESARDZĪGI

#### Atveriet eņģu nodalījumu!

Pirkstu saspiešana / iesprūšana

- ▶ Neievietojiet rokas eņģu nodalījumā.
- ▶ Valkājiet aizsargcimdus.



### ⚠ ESIET PIESARDZĪGI

#### Krītošu detaļu risks, ko izraisa vaļīgas skrūves!

Krītošu detaļu izraisītas traumas.

- ▶ Nostipriniet detaļu, lai tā nenokristu.



### UZMANĪBU!

#### Krītošu detaļu risks, ko izraisa vaļīgas skrūves!

Citu ierīces detaļu bojājumi vai bojājumi, kas rodas klienta mājās, piem., apakšpuse.

- ▶ Nostipriniet detaļu, lai tā nenokristu.

#### Prasība:

- ✔ Ierīcei ir jābūt atvienotai no strāvas padeves.
- ✔ Ierīcei ir jābūt atvienotai no ūdens padeves.
- ✔ Durvis ir atvērtas.

## 4.5.1 Durtiņu noņemšana

1. Izskrūvējiet skrūves (1).

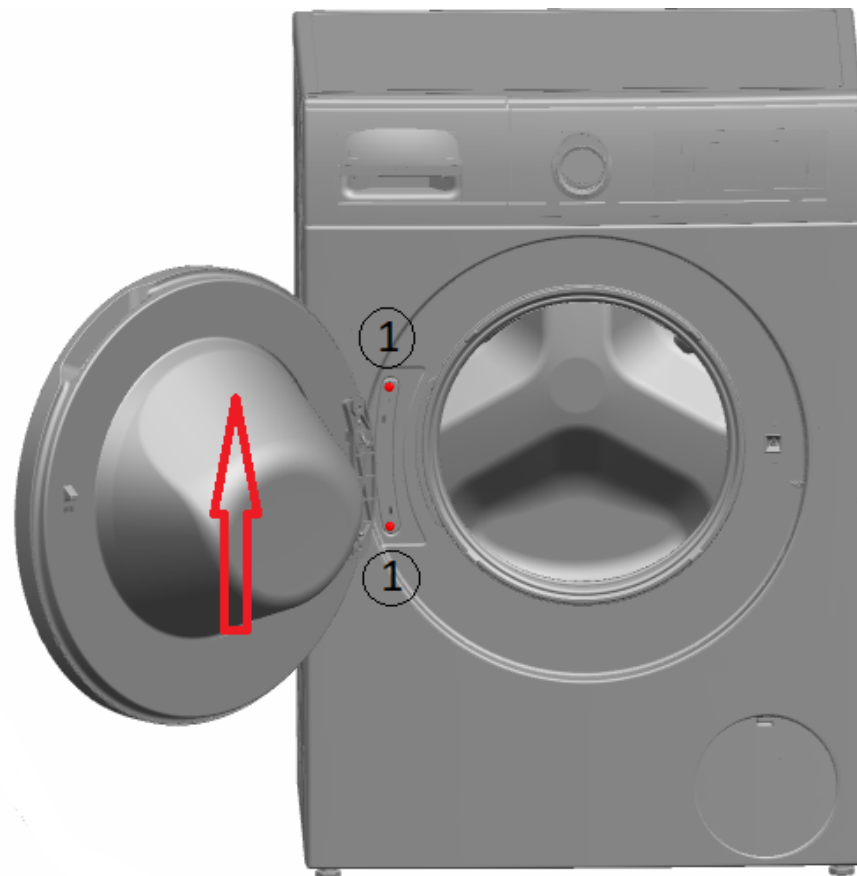



2. Izņemiet durvis, virzot tās augšup.

## 4.5.2 Durtiņu uzstādīšana

- ▶ Uzstādiet apgrieztā kārtībā.

## 4.6 Durtiņu detaļu nomaīņa

	<b>BRĪDINĀJUMS</b>
	<b>Smagas un kustīgas detaļas!</b> Saspiešanas risks labošanas, uzturēšanas, traucējumu novēršanas un apkopes laikā <ul style="list-style-type: none"><li>▶ Valkājiet aizsargapavus.</li><li>▶ Nostipriniet smagas detaļas, lai tās nenokristu.</li><li>▶ Neievietojiet ķermeņa daļas kustīgās detaļās.</li></ul>

	<b>ESIET PIESARDŽĪGI</b>
	<b>Atveriet eņģu nodalījumu!</b> Pirkstu saspiešana / iesprūšana <ul style="list-style-type: none"><li>▶ Neievietojiet rokas eņģu nodalījumā.</li><li>▶ Valkājiet aizsargcimdus.</li></ul>

### Prasība:

- ✓ Ierīcei ir jābūt atvienotai no strāvas padeves.
- ✓ Ierīcei ir jābūt atvienotai no ūdens padeves.
- ✓ [Durtiņas ir noņemtas.→262](#)

### 4.6.1 Durtiņu daļu noņemšana

- ▶ Izjauciet durtiņas no ārpuses uz iekšpusi.

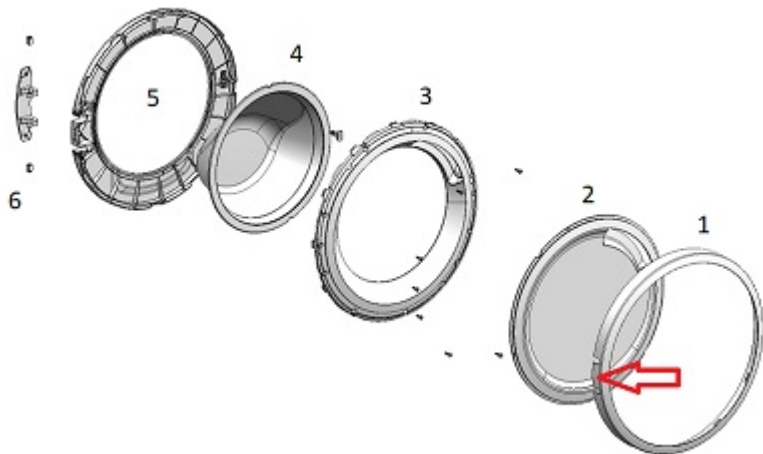

### 4.6.2 Durtiņu daļu uzstādīšana

- ▶ Uzstādiet apgrieztā kārtībā.

## 4.7 Sūkņa vāka nomaiņa

### Prasība:

- ✓ Ierīcei ir jābūt atvienotai no strāvas padeves.
- ✓ Ierīcei ir jābūt atvienotai no ūdens padeves.

### 4.7.1 Sūkņa vāka noņemšana

1. Atveriet sūkņa vāku.

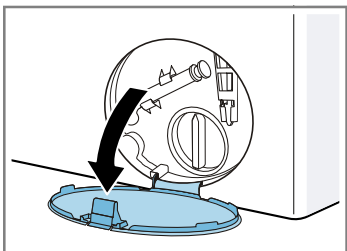

2. Noņemiet sūkņa vāku.

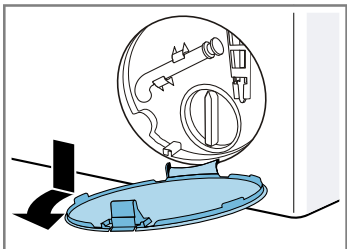



### 4.7.2 Sūkņa vāka uzstādīšana

- ▶ Uzstādiet apgrieztā kārtībā.

## 4.8 Durtiņu blīves nomaiņa

	<b>⚠ ESIET PIESARDZĪGI</b> <b>Asas korpusa malas!</b> Griezumu traumas ▶ Valkājiet aizsargcimdus.
--	--

	<b>⚠ ESIET PIESARDZĪGI</b> <b>Krītošu detaļu risks, ko izraisa vaļīgās skrūves!</b> Krītošu detaļu izraisītas traumas. ▶ Nostipriniet detaļu, lai tā nenokristu.
--	---

	<b>UZMANĪBU!</b> <b>Krītošu detaļu risks, ko izraisa vaļīgās skrūves!</b> Citu ierīces detaļu bojājumi vai bojājumi, kas rodas klienta mājās, piem., apakšpuse. ▶ Nostipriniet detaļu, lai tā nenokristu.
--	--

### Prasība:

- ✓ Ierīcei ir jābūt atvienotai no strāvas padeves.
- ✓ Ierīcei ir jābūt atvienotai no ūdens padeves.
- ✓ Ierīcei var netraucēti piekļūt.
- ✓ [Darbvirsma noņemta.→257](#)
- ✓ [Izņemta mazgāšanas līdzekļa atvilktnē.→258](#)
- ✓ [Priekšējā paneļa pārsegs ir noņemts.→260](#)
- ✓ [Durtiņas ir noņemtas.→262](#)
- ✓ [Noņemts sūkņa vāks.→264](#)
- ✓ [Priekšējais panelis ir noņemts.→269](#)
- ✓ [Drum light apgaismojums ir noņemts \(nav obligāti\).→268](#)

## 4.8.1 Durtiņu blīves noņemšana

1. Atvienojiet visus cauruļu savienojumus.

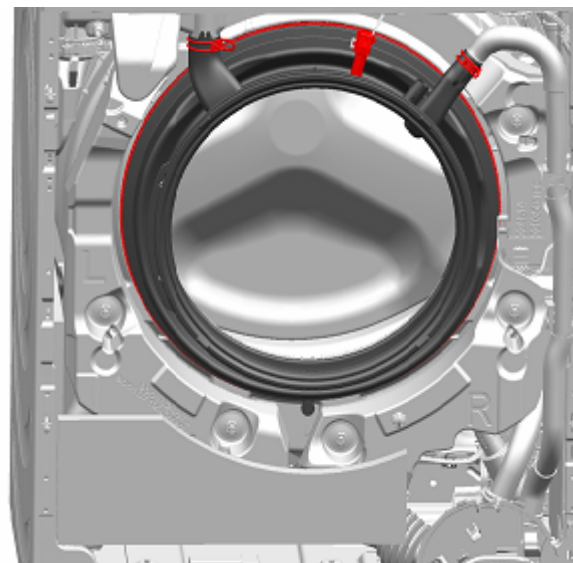

2. Noņemiet durvju blīvējumu.

## 4.8.2 Durtiņu blīvējuma uzstādīšana

	<b>⚠ BRĪDINĀJUMS</b> <b>Krītošu daļu risks nepareizas uzstādīšanas dēļ!</b> Savainojumi vai ierīces bojājumi. ▶ Pievelciet tvertnes blīvslēga spriegotājgredzenu ar 3,4 Nm griezes momentu.
--	--

- ▶ Uzstādiet apgrieztā kārtībā.

## 4.9 Durtiņu slēga nomaiņa

Atbilstīgi Regulai (ES) 2019/2023 mums kā ražotājam ir jānodrošina patērētājiem rezerves durvju slēdzene, ieskaitot remonta instrukciju. Tomēr vēlamies norādīt, ka pēc durvju slēdzenes maiņas kvalificētam elektriķim ir jāpārbauda ierīces elektrodrošība, pirms to sāk izmantot. Elektriķim ir jāapliecina sava kvalifikācija atbilstīgi valsts tiesību aktiem, noteikumiem un prasībām.

	<p><b>⚠ BĪSTAMI</b></p> <p><b>Elektrotrieciena risks spriegumaktīvu daļu dēļ!</b> Dzīvības apdraudējums nepareiza remonta izraisīta elektrotrieciena dēļ</p> <ul style="list-style-type: none"><li>▶ Elektriskās daļas ir jāremontē kvalificētam elektriķim.</li><li>▶ Pēc remonta ierīces drošība ir jāpārbauda atbilstīgi noteikumiem VDE 0701 vai valsts noteikumiem.</li></ul>
	<p><b>⚠ BRĪDINĀJUMS</b></p> <p><b>Sasvērušos ierīču paslīdēšana!</b> Kaulu lūzumi / saspiešanas traumas</p> <ul style="list-style-type: none"><li>▶ Nostipriniet ierīces, lai tās neslīdētu.</li></ul>
	<p><b>⚠ ESIET PIESARDZĪGI</b></p> <p><b>Asas korpusa malas!</b> Griezumu traumas</p> <ul style="list-style-type: none"><li>▶ Valkājiet aizsargcimdus.</li></ul>
	<p><b>⚠ ESIET PIESARDZĪGI</b></p> <p><b>Krītošu detaļu risks, ko izraisa vaļīgas skrūves!</b> Krītošu detaļu izraisītas traumas.</p> <ul style="list-style-type: none"><li>▶ Nostipriniet detaļu, lai tā nenokristu.</li></ul>
	<p><b>UZMANĪBU!</b></p> <p><b>Krītošu detaļu risks, ko izraisa vaļīgas skrūves!</b> Citu ierīces detaļu bojājumi vai bojājumi, kas rodas klienta mājās, piem., apakšpuse.</p> <ul style="list-style-type: none"><li>▶ Nostipriniet detaļu, lai tā nenokristu.</li></ul>

### Prasība:

- ✓ Ierīcei ir jābūt atvienotai no strāvas padeves.
- ✓ Ierīcei ir jābūt atvienotai no ūdens padeves.

- ✓ Ierīcei var netraucēti piekļūt.
- ✓ [Darbvirsma noņemta.→257](#)
- ✓ [Izņemta mazgāšanas līdzekļa atvilktnē.→258](#)
- ✓ [Priekšējā paneļa pārsegs ir noņemts.→260](#)
- ✓ [Durtiņas ir noņemtas.→262](#)
- ✓ Spriegotāja gredzens ir noņemts.
- ✓ [Durvju blīvējums ir noņemts.→265](#)
- ✓ [Noņemts sūkņa vāks.→264](#)
- ✓ [Priekšējais panelis ir noņemts.→269](#)

### 4.9.1 Durtiņu slēga noņemšana

1. Atvienojiet durtiņu slēga spraudni.
2. Atbrīvojiet durtiņu slēgu.



3. Noņemiet durtiņu slēgu.

### 4.9.2 Durtiņu slēga uzstādīšana

Durtiņu slēgam ir jāatrodas pareizajā pozīcijā, lai nodrošinātu, ka iespējama ierīces durtiņu atvēršana ārkārtas situācijā.

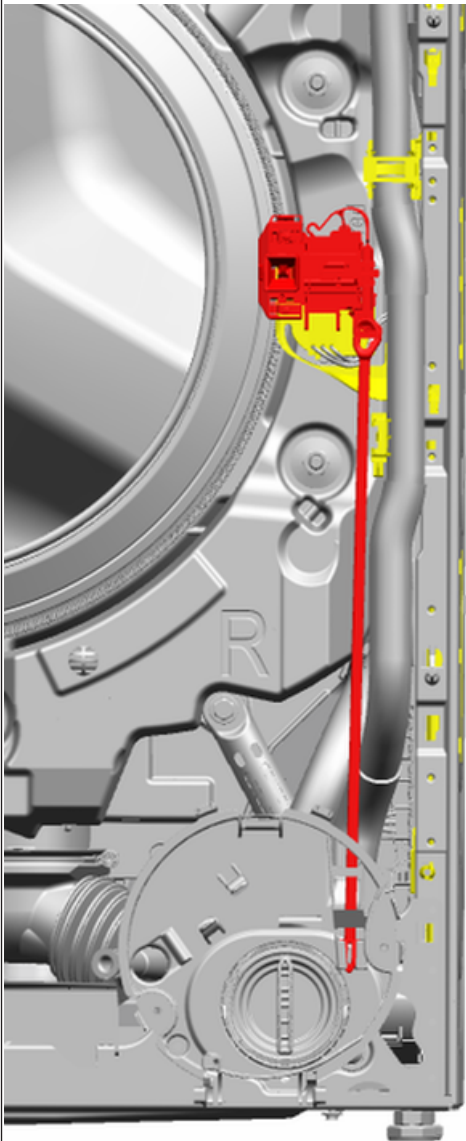

- ▶ Uzstādiet apgrieztā kārtībā.

## 4.10 Bunduļa lampiņas nomaiņa



### BRĪDINĀJUMS

#### Sasvērušos ierīču paslīdēšana!

Kaulu lūzumi / saspiešanas traumas

- ▶ Nostipriniet ierīces, lai tās neslīdētu.



### ESIET PIESARDZĪGI

#### Asas korpusa malas!

Griezumu traumas

- ▶ Valkājiet aizsargcimdus.



### ESIET PIESARDZĪGI

#### Krītošu detaļu risks, ko izraisa vaļīgās skrūves!

Krītošu detaļu izraisītas traumas.

- ▶ Nostipriniet detaļu, lai tā nenokristu.



### UZMANĪBU!

#### Krītošu detaļu risks, ko izraisa vaļīgās skrūves!

Citu ierīces detaļu bojājumi vai bojājumi, kas rodas klienta mājās, piem., apakšpuse.

- ▶ Nostipriniet detaļu, lai tā nenokristu.

#### Prasība:

- ✓ Ierīcei ir jābūt atvienotai no strāvas padeves.
- ✓ Ierīcei ir jābūt atvienotai no ūdens padeves.
- ✓ Ierīcei var netraucēti piekļūt.
- ✓ [Darbvirsma noņemta.→257](#)
- ✓ [Izņemta mazgāšanas līdzekļa atvilkne.→258](#)
- ✓ [Priekšējā paneļa pārsegs ir noņemts.→260](#)

## 4.10.1 Bunduļa lampiņas izņemšana

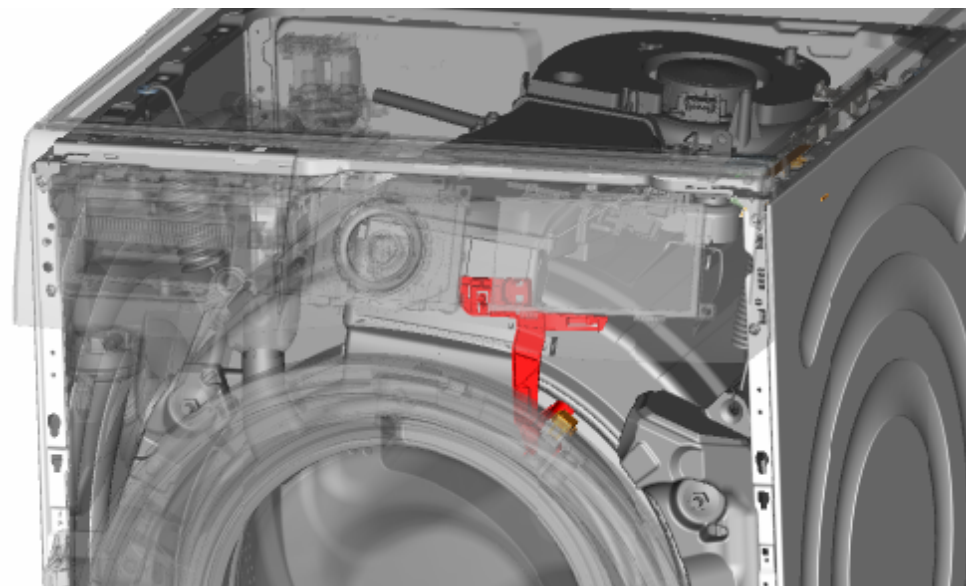

1. Izvelciet bunduļa lampiņas turētāju no ierīces.
2. Atvienojiet elektrosavienojumus.
3. Izņemiet bunduļa lampiņu no bunduļa lampiņas turētāja.

## 4.10.2 Bunduļa lampiņas uzstādīšana



Ņemiet vērā kabeļu izvietojumu. Kabelis var tikt iespiests.

- ▶ Uzstādiet apgrieztā kārtībā.

## 4.11 Priekšējā paneļa nomaīņa



### BRĪDINĀJUMS

#### Sasvērušos ierīču paslīdēšana!

Kaulu lūzumi / saspiešanas traumas

- ▶ Nostipriniet ierīces, lai tās neslīdētu.



### ESIET PIESARDZĪGI

#### Asas korpusa malas!

Griezumu traumas

- ▶ Valkājiet aizsargcimdus.



### ESIET PIESARDZĪGI

#### Krītošu detaļu risks, ko izraisa vaļīgas skrūves!

Krītošu detaļu izraisītas traumas.

- ▶ Nostipriniet detaļu, lai tā nenokristu.



### UZMANĪBU!

#### Krītošu detaļu risks, ko izraisa vaļīgas skrūves!

Citu ierīces detaļu bojājumi vai bojājumi, kas rodas klienta mājās, piem., apakšpusē.

- ▶ Nostipriniet detaļu, lai tā nenokristu.

#### Prasība:

- ✓ Ierīcei ir jābūt atvienotai no strāvas padeves.
- ✓ Ierīcei ir jābūt atvienotai no ūdens padeves.
- ✓ Ierīcei var netraucēti piekļūt.
- ✓ [Darbvirsma noņemta. →257](#)
- ✓ [Izņemta mazgāšanas līdzekļa atvilktnē. →258](#)
- ✓ [Priekšējā paneļa pārsegs ir noņemts. →260](#)
- ✓ [Durtiņas ir noņemtas. →262](#)
- ✓ [Noņemts sūkņa vāks. →264](#)
- ✓ Spriegotāja gredzens ir noņemts.
- ✓ Durvju blīvējums priekšdaļā ir atbrīvots.
- ✓ [Drum light apgaismojums ir noņemts \(nav obligāti\). →268](#)

## 4.11.1 Priekšējā paneļa noņemšana

1. Paceliet ierīces priekšdaļu.
2. Izskrūvējiet skrūves apakšpusē (1).

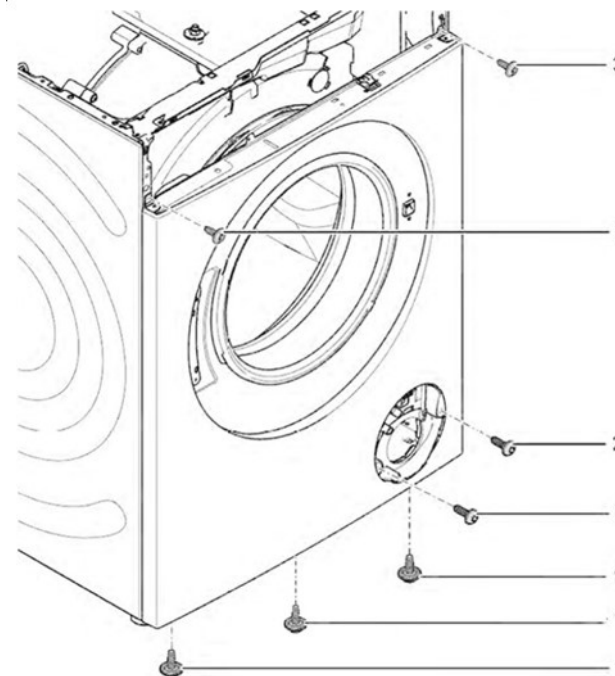

3. Nolaidiet ierīci.

4. Izskrūvējiet skrūves priekšpusē no apakšas uz augšu (2, 3).

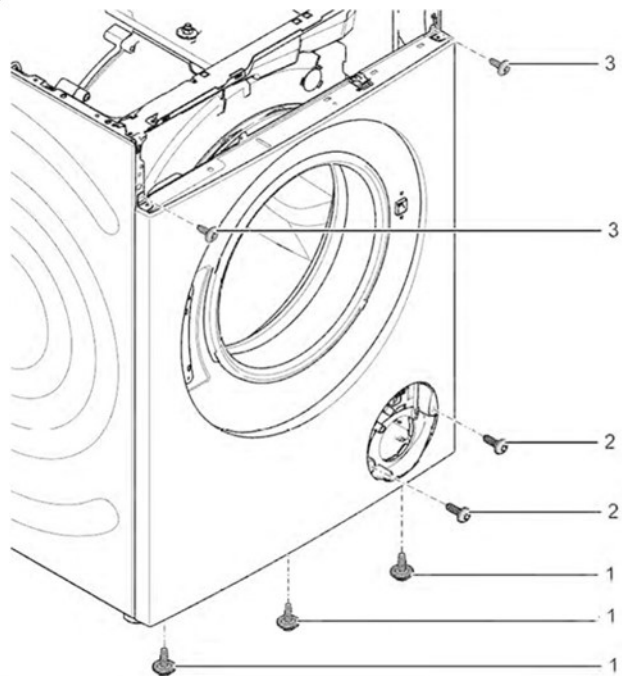

5. Noņemiet priekšējo paneli.

### 4.11.2 Priekšējā paneļa uzstādīšana

- ▶ Uzstādiet apgrieztā kārtībā.

# Informacija apie remontą - Skalbyklė

## Dėl šio dokumento..... 272

1.1	Svarbi informacija.....	272
1.1.1	Paskirtis.....	272
1.2	Simbolių paaiškinimas.....	272
1.2.1	Pavojaus lygiai.....	272
1.2.2	Pavojaus simboliai.....	272
1.2.3	Įspėjimų struktūra.....	273
1.2.4	Bendrieji simboliai.....	273

## Sauga..... 274

2.1	Bendrosios saugos instrukcijos.....	274
2.1.1	Visi buitiniai prietaisai.....	274

## Įrankiai ir pagalbinės priemonės..... 275

## Remontas..... 276

4.1	Stalviršio keitimas.....	276
4.1.1	Stalviršio nuėmimas.....	276
4.1.2	Stalviršio uždėjimas.....	276
4.2	Skalbiklio stalčiaus keitimas.....	277
4.2.1	Skalbiklio stalčiaus išėmimas.....	277
4.2.2	Skalbiklio stalčiaus įdėjimas.....	277
4.3	Skalbiklio stalčiaus dangtelio keitimas.....	278
4.3.1	Skalbiklio stalčiaus dangtelio nuėmimas.....	278
4.3.2	Skalbiklio stalčiaus dangtelio uždėjimas.....	278
4.4	Antjuostės keitimas.....	279
4.4.1	Antjuostės nuėmimas.....	279
4.4.2	Antjuostės uždėjimas.....	280
4.5	Durelių keitimas.....	281
4.5.1	Durelių nuėmimas.....	281
4.5.2	Durelių uždėjimas.....	281
4.6	Durelių konstrukcinių dalių keitimas.....	282
4.6.1	Durelių konstrukcinių dalių nuėmimas.....	282
4.6.2	Durelių konstrukcinių dalių uždėjimas.....	282
4.7	Siurblio dangtelio keitimas.....	283
4.7.1	Siurblio dangtelio nuėmimas.....	283
4.7.2	Siurblio dangtelio uždėjimas.....	283

4.8	Durelių sandariklio keitimas.....	284
4.8.1	Durelių sandariklio nuėmimas.....	284
4.8.2	Durelių sandariklio uždėjimas.....	284
4.9	Durelių užrakto keitimas.....	285
4.9.1	Durelių užrakto nuėmimas.....	285
4.9.2	Durelių užrakto sumontavimas.....	286
4.10	Būgno apšvietimo keitimas.....	287
4.10.1	Būgno apšvietimo nuėmimas.....	287
4.10.2	Būgno apšvietimo sumontavimas.....	287
4.11	Priekinio skydo keitimas.....	288
4.11.1	Priekinio skydo nuėmimas.....	288
4.11.2	Priekinio skydo uždėjimas.....	289

# **i** Dėl šio dokumento

## 1.1 Svarbi informacija

### 1.1.1 Paskirtis

Šios remonto nuorodos padeda naudotojui pataisyti prietaisus patiems pagal galiojantį ekologinio projektavimo reglamentą (2021 m. kovo mėn. redakcija).





Jose pateikta informacija, kaip pakeisti tam tikras atsargines dalis, įskaitant ir įspėjimus bei riziką.

Jei kiltų klausimų, kreipkitės į mūsų klientų aptarnavimo tarnybą. Mes atsakysime už žalą tik tuo atveju, jei bus tinkamai laikomasi remonto nuorodų.

## 1.2 Simbolių paaiškinimas

### 1.2.1 Pavojaus lygiai

Įspėjimo lygiai susideda iš simbolio ir signalinio žodžio. Signalinis žodis nurodo pavojaus sunkumą.





Įspėjimo lygis	Reikšmė
 <b>PAVOJUS</b>	Nepaisant įspėjamojo pranešimo, ištinka mirtis arba sunkūs sužalojimai.
 <b>ĮSPĖJIMAS</b>	Nepaisant įspėjamojo pranešimo, gali ištikti mirtis arba sunkūs sužalojimai.
 <b>PERSPĖJIMAS</b>	Nepaisant įspėjamojo pranešimo, galimi nedideli sužalojimai.
 <b>DĖMESIO!</b>	Nepaisant įspėjamojo pranešimo, gali būti sugadintas turtas.

Lentelė 1: Pavojaus lygiai



### 1.2.2 Pavojaus simboliai

Pavojaus simboliai yra simboliniai atvaizdai, nurodantys pavojaus rūšį.

Šiame: dokumente naudojami tokie pavojaus simboliai

Pavojaus simbolis	Reikšmė
	Bendras įspėjamasis pranešimas
	Pavojinga elektros įtampa
	Sprogimo pavojus
	Įpjovimo pavojus
	Prispaudimo pavojus

## **i** Dėl šio dokumento

Pavojaus simbolis	Reikšmė
	Pavojus dėl karštų paviršių
	Pavojus dėl stipraus magnetinio lauko
	Pavojus dėl nejonizuojančiosios spinduliuotės

Lentelė 2: Pavojaus simboliai

### 1.2.3 Įspėjimų struktūra

Šiame dokumente pateikiami įspėjimai yra standartizuotos išvaizdos ir standartizuotos struktūros.



	<div style="background-color: red; color: white; padding: 2px; text-align: center;"><b>⚠ PAVOJUS</b></div> <p><b>Pavojaus tipas ir šaltinis!</b> Galimos pasekmės, jei nepaisoma pavojaus / įspėjimo.</p> <ul style="list-style-type: none"> <li>▶ Priemonės ir draudimai pavojui išvengti.</li> </ul>
--	--





Šiame pavyzdyje parodytas įspėjimas, įspėjantis apie elektros smūgį dėl dalių su įtampa. Paminėta priemonė, kaip išvengti pavojaus.

	<div style="background-color: red; color: white; padding: 2px; text-align: center;"><b>⚠ PAVOJUS</b></div> <p><b>Elektros smūgio pavojus dėl dalių, kuriose yra įtampa!</b> Mirtis dėl elektros smūgio</p> <ul style="list-style-type: none"> <li>▶ Prieš pradėdami remontą, ne mažiau kaip prieš 60 sekundžių atjunkite prietaisus nuo elektros tiekimo.</li> </ul>
---	--

### 1.2.4 Bendrieji simboliai

Šiame dokumente naudojami tokie bendrieji simboliai:

Bendr. simbolis	Reikšmė
	Žymi specialų patarimą (tekstas ir (arba) grafika)
	Žymi paprastą patarimą (tik tekstas)
	Žymi nuorodą į vaizdo pamoką

Bendr. simbolis	Reikšmė
	Žymi reikalingus įrankius
	Žymi reikalingas prielaidas
	Žymi sąlygą (jei ..., tai ...)
	Žymi rezultatą
<code>[Paleisti]</code>	Žymi klavišą arba ekrano mygtuką
<code>[00123456]</code>	Žymi dalies numerį
<code>Būsena</code>	Žymi rodomą tekstą / langą (prietaiso ekrane)

Lentelė 3: Bendrieji simboliai

## 2.1 Bendrosios saugos instrukcijos

### 2.1.1 Visi būtiniai prietaisai

#### **Elektros smūgio pavojus dėl dalių, kuriose yra įtampa!**

- Elektrinių konstrukcinių dalių remonto klaidos gali sukelti elektros smūgį!
- Prieš pradėdami dirbti, ne mažiau kaip prieš 60 sekundžių atjunkite prietaisą nuo maitinimo.
- Po remonto pasirūpinkite, kad būtų atliktas saugos bandymas pagal VDE 0701 arba šalyje galiojančius reglamentus.

#### **Pavojus susižeisti į aštrias briaunas!**

- Mūvėkite apsaugines pirštines.

#### **Prispaudimo rizika remonto, einamosios techninės priežiūros, sutrikimų šalinimo ir techninės priežiūros metu dėl sunkių ir judančių konstrukcinių dalių**

- Avėkite apsauginius batus.
- Apsaugokite sunkias konstrukcines dalis, kad jos nenukristų.
- Neartinkite kūno dalių prie judančių konstrukcinių dalių.







#### **Rizika prietaiso saugai / veikimui!**





- Naudokite tik originalias atsargines dalis.

#### **Elektrostatškai jautrių konstrukcinių dalių (ESD) pažeidimo rizika!**

- Nelieskite modulių, o taip pat ir jų jungčių bei laidininkų kelių.

## Įrankiai ir pagalbinės priemonės

Paskyrimas	Išsami informacija	Vaizdai
Pagalbinis įrankis [15000155]	Įrankis plastikinėms dalims atpalaiduoti	
„Torx T20“ atsuktuvai su kiauryme [00340764]	100 mm, varžtams su saugos kaiščiu	
Dinamometrinis veržliaraktis [15000441]	Dinamometrinis veržliaraktis 20–100 Nm	
Atsuktuvai su įpjova [00340854]	Mentė 3,5 mm x 0,6 mm x 100 mm, apsauginė izoliacija 1000 V AC	
Atsuktuvai su įpjova [00340855]	Mentė 5,5 mm x 1,0 mm x 125 mm, apsauginė izoliacija 1000 V AC	
Adatinės replės, kampinės [00341269]	Ilgis 200 mm	
Šonu pjaunančios replės [00342182]	Ilgis: 200 mm	



Paskyrimas	Išsami informacija	Vaizdai
Kombinuotas veržliaraktis [00340811]	Rakto plotis 10 <sup>o</sup> mm, M6	
Combination wrench [00340814]	Rakto plotis 13 <sup>o</sup> mm, M8	
Kombinuotas veržliaraktis [00340817]	Rakto plotis 17 mm, M10	
Kombinuotas veržliaraktis [15000459]	Rakto plotis 16 <sup>o</sup> mm, M10	

## 4.1 Stalviršio keitimas

### Specialūs įrankiai.

-  Tuščiaaviduris TORX antgalis TX20 Ilgis 152 mm, naudojamas ilgis 124 mm, 1/4" šešiabriaunis galas (6,35 mm), varžtams su saugos kaiščiu [00341272]

### Reikalavimas.

-  Prietaisas atjungtas nuo maitinimo šaltinio.
-  Prietaisas atjungtas nuo vandens tiekimo.

### 4.1.1 Stalviršio nuėmimas

- ▶ 1. Išsukite varžtus (1).
- ▶ 2. Nustumkite stalviršį prietaiso galo link (2).
- ▶ 3. Nuimkite stalviršį, keldami jį aukštyn (3).

### 4.1.2 Stalviršio uždėjimas

	Atkreipkite dėmesį į kabelio įmontavimą. Gabelis gali prisispauti.
---	--

- ▶ Uždėkite atvirkščia eilės tvarka.

## 4.2 Skalbiklio stalčiaus keitimas

### Reikalavimas.

- ✓ Prietaisas atjungtas nuo maitinimo šaltinio.
- ✓ Prietaisas atjungtas nuo vandens tiekimo.

### 4.2.1 Skalbiklio stalčiaus išėmimas

1. Ištraukite skalbiklio stalčių.
2. 1. Paspauskite įdėklą (1) žemyn.  
2. Išimkite skalbiklio stalčių (2).

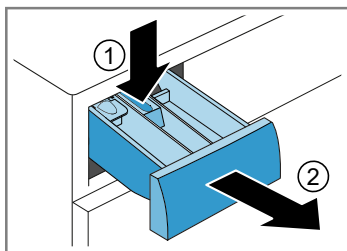

### 4.2.2 Skalbiklio stalčiaus įdėjimas

- ▶ Uždėkite atvirkščia eilės tvarka.

## 4.3 Skalbiklio stalčiaus dangtelio keitimas

### Reikalavimas.

- ✔ Prietaisas atjungtas nuo maitinimo šaltinio.
- ✔ Prietaisas atjungtas nuo vandens tiekimo.
- ✔ [Išimtas skalbiklio stalčius.→277](#)

### 4.3.1 Skalbiklio stalčiaus dangtelio nuėmimas

1. Atpalaiduokite spraudes.

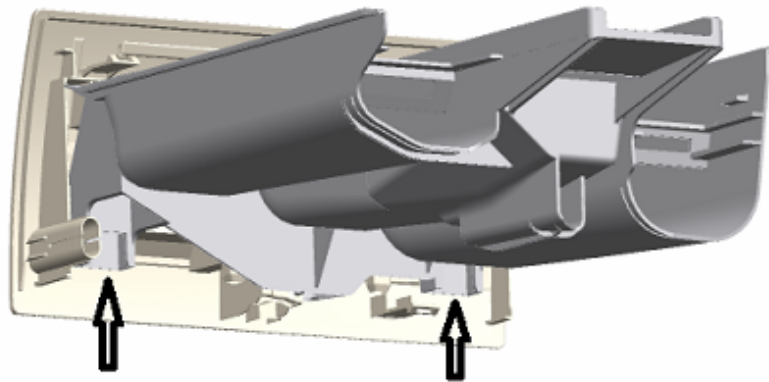





2. Nuimkite skalbiklio stalčiaus dangtelį.

### 4.3.2 Skalbiklio stalčiaus dangtelio uždėjimas

- ▶ Uždėkite atvirkščia eilės tvarka.

## 4.4 Antjuostės keitimas

Kaip gamintojas pagal Reglamentą (ES) 2019/2023 esame įsipareigoję klientams pateikti atsarginę antjuostę, įskaitant remonto instrukcijas. Tačiau norime atkreipti dėmesį, kad pakeitus antjuostę, prieš pradėdant naudoti prietaisą, kvalifikuotas elektrikas privalo atlikti elektrotechninės saugos bandymą. Šis asmuo turi būti kvalifikuotas pagal šalyje galiojančius įstatymus, reglamentus ir standartus.

	<p style="text-align: center;"><b>⚠ PAVOJUS</b></p> <p><b>Elektros smūgio pavojus dėl dalių, kuriose yra įtampa!</b>  Pavojus gyvybei dėl elektros smūgio netinkamo remonto atveju</p> <ul style="list-style-type: none"> <li>▶ Elektrinės dalis remontuoti turi kvalifikuoti elektrikai.</li> <li>▶ Po remonto pasirūpinkite, kad būtų atliktas saugos bandymas pagal VDE 0701 arba šalyje galiojančius reglamentus.</li> </ul>
	<p style="text-align: center;"><b>⚠ ĮSPĖJIMAS</b></p> <p><b>Paverstų prietaisų slidimas!</b>  Galimi kaulų lūžiai ir prispaudimai</p> <ul style="list-style-type: none"> <li>▶ Apsaugokite prietaisus, kad jie nepaslystų.</li> </ul>
	<p style="text-align: center;"><b>⚠ PERSPĖJIMAS</b></p> <p><b>Aštrios korpuso briaunos!</b>  Galima įsipjauti</p> <ul style="list-style-type: none"> <li>▶ Mūvėkite apsaugines pirštines.</li> </ul>
	<p style="text-align: center;"><b>⚠ PERSPĖJIMAS</b></p> <p><b>Pavojus, kad atpalaidavus varžtus dalys nukris!</b>  Krentančios dalys gali sužeisti.</p> <ul style="list-style-type: none"> <li>▶ Apsaugokite konstrukcinę dalį, kad ji nenukristų.</li> </ul>
	<p style="text-align: center;"><b>⚠ DĖMESIO!</b></p> <p><b>Pavojus, kad atpalaidavus varžtus dalys nukris!</b>  Gali būti sugadintos kitos prietaiso dalys arba kliento namai, pvz., grindys.</p> <ul style="list-style-type: none"> <li>▶ Apsaugokite konstrukcinę dalį, kad ji nenukristų.</li> </ul>

### Reikalavimas.

- ✓ Prietaisas atjungtas nuo maitinimo šaltinio.
- ✓ Prietaisas atjungtas nuo vandens tiekimo.

✓ [Stalviršis nuimtas.→276](#)

✓ [Išimtas skalbiklio stalčius.→277](#)

### 4.4.1 Antjuostės nuėmimas

1. Išsukite varžtus (1).
2. Atpalaiduokite spraudes (2, 3).

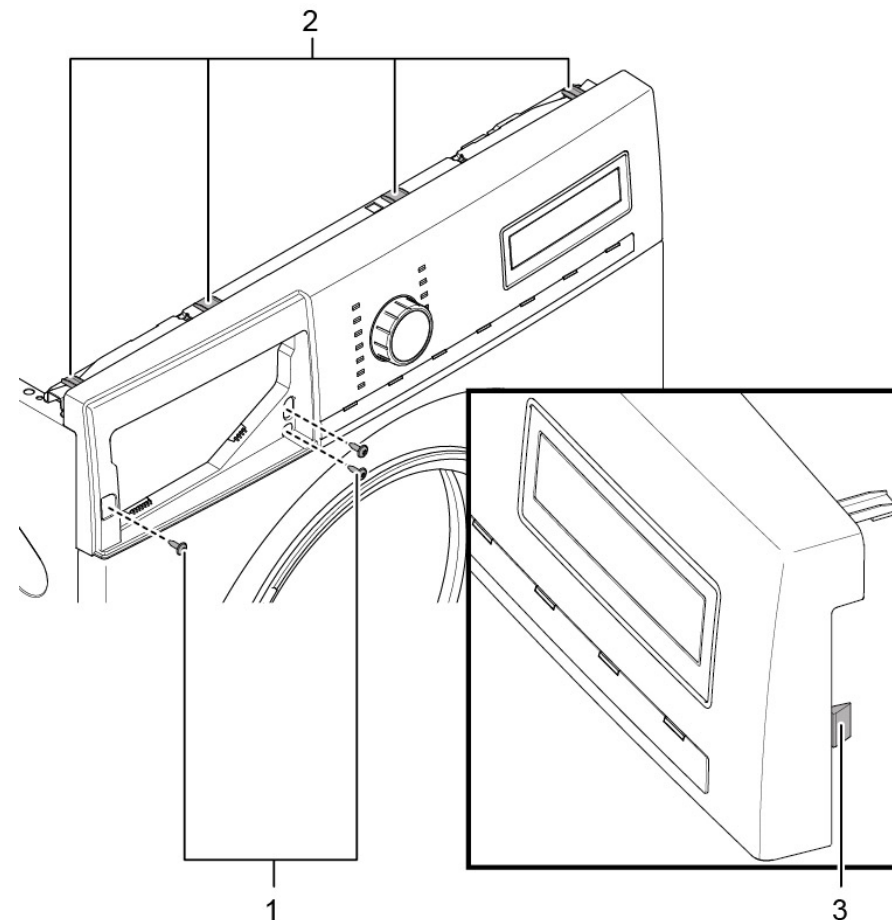

2. Atjunkite valdymo bloko kištukinį kontaktą.
3. Nuimkite antjuostę.

## 4.4.2 Antjuostės uždėjimas



Atkreipkite dėmesį į kabelio įmontavimą. Gabelis gali prisispausti.

- ▶ Uždėkite atvirkščia eilės tvarka.

## 4.5 Durelių keitimas



### ⚠ PERSPĖJIMAS

#### Atvira vyrių sritis!

Galima prispausti / prisiverti pirštus

- ▶ Nekiškite rankų į vyrių sritį.
- ▶ Mūvėkite apsaugines pirštines.



### ⚠ PERSPĖJIMAS

#### Pavojus, kad atpalaidavus varžtus dalys nukris!

Krentančios dalys gali sužeisti.

- ▶ Apsaugokite konstrukcinę dalį, kad ji nenukristų.



### DĖMESIO!

#### Pavojus, kad atpalaidavus varžtus dalys nukris!

Gali būti sugadintos kitos prietaiso dalys arba kliento namai, pvz., grindys.

- ▶ Apsaugokite konstrukcinę dalį, kad ji nenukristų.

#### Reikalavimas.

- ✔ Prietaisas atjungtas nuo maitinimo šaltinio.
- ✔ Prietaisas atjungtas nuo vandens tiekimo.
- ✔ Durelės atidarytos.

### 4.5.1 Durelių nuėmimas

1. Išsukite varžtus (1).

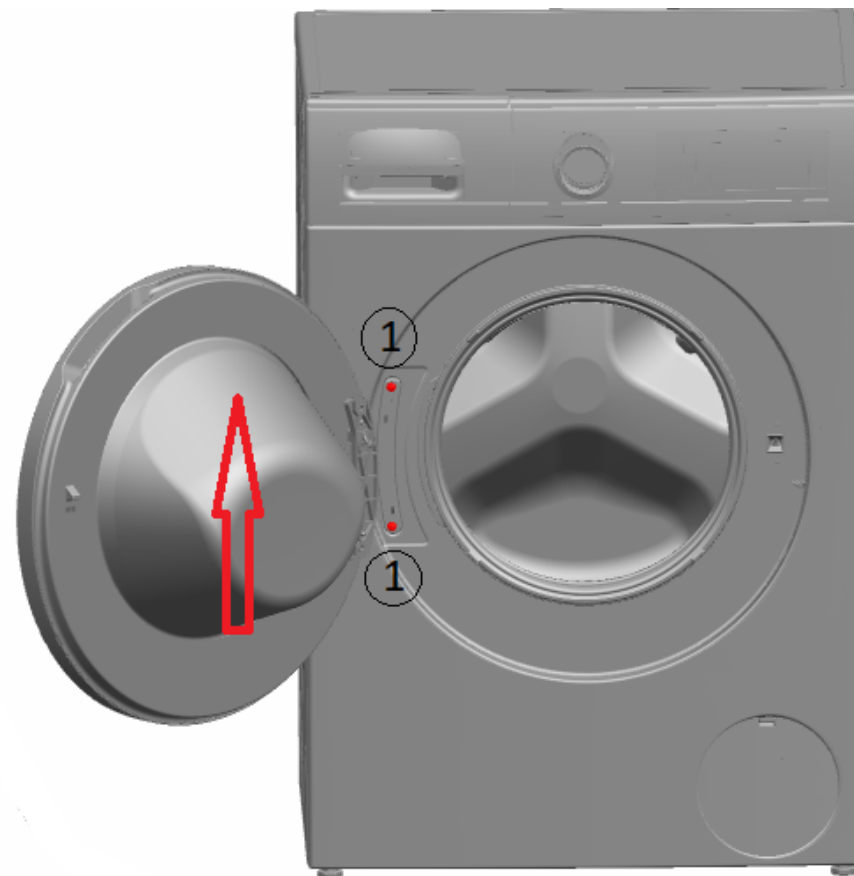



2. Nuimkite dureles, keldami aukštyn.

### 4.5.2 Durelių uždėjimas

- ▶ Uždėkite atvirkščia eilės tvarka.

## 4.6 Durelių konstrukcinių dalių keitimas

	<p><b>⚠ ĮSPĖJIMAS</b></p> <p><b>Sunkios ir judžios konstrukcinės dalys!</b> Prispaudimo rizika remonto, einamosios techninės priežiūros, sutrikimų šalinimo ir techninės priežiūros metu</p> <ul style="list-style-type: none"><li>▶ Avėkite apsauginius batus.</li><li>▶ Apsaugokite sunkias konstrukcines dalis, kad jos nenukristų.</li><li>▶ Nekiškite kūno dalių į judžias konstrukcines dalis.</li></ul>
	<p><b>⚠ PERSPĖJIMAS</b></p> <p><b>Atvira vyrių sritis!</b> Galima prispausti / prisiverti pirštus</p> <ul style="list-style-type: none"><li>▶ Nekiškite rankų į vyrių sritį.</li><li>▶ Mūvėkite apsaugines pirštines.</li></ul>

### Reikalavimas.

- ✓ Prietaisas atjungtas nuo maitinimo šaltinio.
- ✓ Prietaisas atjungtas nuo vandens tiekimo.
- ✓ [Durelės nuimtos.→281](#)

### 4.6.1 Durelių konstrukcinių dalių nuėmimas

- ▶ Išardykite dureles nuo išorės vidaus link.

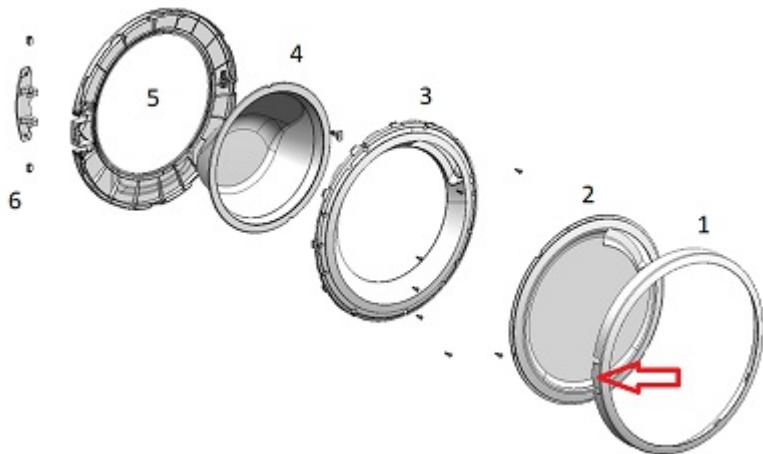

### 4.6.2 Durelių konstrukcinių dalių uždėjimas

- ▶ Uždėkite atvirkščia eilės tvarka.

## 4.7 Siurblio dangtelio keitimas

### Reikalavimas.

- ✔ Prietaisas atjungtas nuo maitinimo šaltinio.
- ✔ Prietaisas atjungtas nuo vandens tiekimo.

### 4.7.1 Siurblio dangtelio nuėmimas

1. Atidarykite siurblio dangtelį.

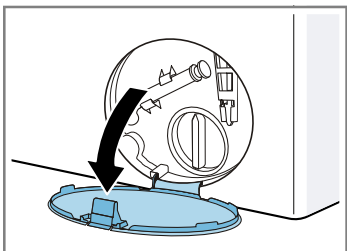

2. Nuimkite siurblio dangtelį.

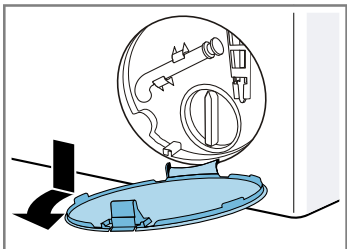



### 4.7.2 Siurblio dangtelio uždėjimas

- ▶ Uždėkite atvirkščia eilės tvarka.

## 4.8 Durelių sandariklio keitimas

	<b>⚠ PERSPĖJIMAS</b> <b>Aštrios korpuso briaunos!</b> Galima įsijauti ▶ Mūvėkite apsaugines pirštines.
--	---

	<b>⚠ PERSPĖJIMAS</b> <b>Pavojus, kad atpalaidavus varžtus dalys nukris!</b> Krentančios dalys gali sužeisti. ▶ Apsaugokite konstrukcinę dalį, kad ji nenukristų.
--	---

	<b>DĖMESIO!</b> <b>Pavojus, kad atpalaidavus varžtus dalys nukris!</b> Gali būti sugadintos kitos prietaiso dalys arba kliento namai, pvz., grindys. ▶ Apsaugokite konstrukcinę dalį, kad ji nenukristų.
--	---

### Reikalavimas.

- ✓ Prietaisas atjungtas nuo maitinimo šaltinio.
- ✓ Prietaisas atjungtas nuo vandens tiekimo.
- ✓ Prietaisai yra laisvai prieinami.
- ✓ [Stalviršis nuimtas.→276](#)
- ✓ [Išimtas skalbiklio stalčius.→277](#)
- ✓ [Antjuostė nuimta.→279](#)
- ✓ [Durelės nuimtos.→281](#)
- ✓ [Siurblio dangtelis nuimtas.→283](#)
- ✓ [Priekinis skydas nuimtas.→288](#)
- ✓ [Būgno apšvietimas nuimtas \(pasirinktis\).→287](#)

## 4.8.1 Durelių sandariklio nuėmimas

1. Atjunkite visas žarnų jungtis.

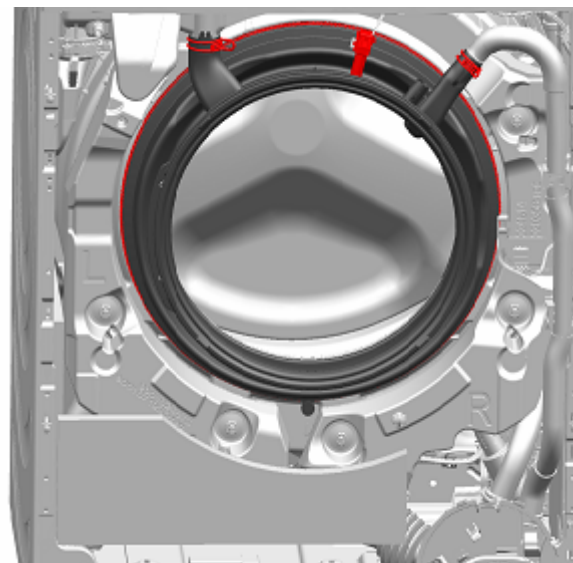

2. Nuimkite durelių sandariklį.

## 4.8.2 Durelių sandariklio uždėjimas

	<b>⚠ ĮSPĖJIMAS</b> <b>Pavojus, kad netinkamai įrengus nukris dalys!</b> Susižalojimas arba prietaiso sugadinimas. ▶ Priveržkite durų tarpinės įtempimo žiedą taikydami 3,4 Nm jėgą.
--	--

- ▶ Uždėkite atvirkščia eilės tvarka.

## 4.9 Durelių užrakto keitimas

Kaip gamintojas pagal Reglamentą (ES) 2019/2023 esame įsipareigoję klientams pateikti atsarginį durų užraktą, įskaitant remonto instrukcijas. Tačiau norime atkreipti dėmesį, kad pakeitus durų užraktą, prieš pradėdant naudoti prietaisą, kvalifikuotas elektri- kas privalo atlikti elektrotechninės saugos bandymą. Šis asmuo turi būti kvalifikuotas pagal šalyje galiojančius įstatymus, reglamentus ir standartus.

	<p><b>⚠ PAVOJUS</b></p> <p><b>Elektros smūgio pavojus dėl dalių, kuriose yra įtampa!</b> Pavojus gyvybei dėl elektros smūgio netinkamo remonto atveju</p> <ul style="list-style-type: none"><li>▶ Elektrinės dalis remontuoti turi kvalifikuoti elektrikai.</li><li>▶ Po remonto pasirūpinkite, kad būtų atliktas saugos bandymas pa- gal VDE 0701 arba šalyje galiojančius reglamentus.</li></ul>
--	--

	<p><b>⚠ ĮSPĖJIMAS</b></p> <p><b>Paverstų prietaisų slydimas!</b> Galimi kaulų lūžiai ir prispaudimai</p> <ul style="list-style-type: none"><li>▶ Apsaugokite prietaisus, kad jie nepaslystų.</li></ul>
--	--

	<p><b>⚠ PERSPĖJIMAS</b></p> <p><b>Aštrios korpuso briaunos!</b> Galima įsipjauti</p> <ul style="list-style-type: none"><li>▶ Mūvėkite apsaugines pirštines.</li></ul>
--	---

	<p><b>⚠ PERSPĖJIMAS</b></p> <p><b>Pavojus, kad atpalaidavus varžtus dalys nukris!</b> Krentančios dalys gali sužeisti.</p> <ul style="list-style-type: none"><li>▶ Apsaugokite konstrukcinę dalį, kad ji nenukristų.</li></ul>
---	--

	<p><b>DĖMESIO!</b></p> <p><b>Pavojus, kad atpalaidavus varžtus dalys nukris!</b> Gali būti sugadintos kitos prietaiso dalys arba kliento namai, pvz., grin- dys.</p> <ul style="list-style-type: none"><li>▶ Apsaugokite konstrukcinę dalį, kad ji nenukristų.</li></ul>
--	--

### Reikalavimas.

- ✓ Prietaisas atjungtas nuo maitinimo šaltinio.
- ✓ Prietaisas atjungtas nuo vandens tiekimo.

- ✓ Prietaisai yra laisvai prieinami.
- ✓ [Stalviršis nuimtas.→276](#)
- ✓ [Išimtas skalbiklio stalčius.→277](#)
- ✓ [Antjuostė nuimta.→279](#)
- ✓ [Durelės nuimtos.→281](#)
- ✓ Veržiamasis žiedas nuimtas.
- ✓ [Durelių sandariklis nuimtas.→284](#)
- ✓ [Siurblio dangtelis nuimtas.→283](#)
- ✓ [Priekinis skydas nuimtas.→288](#)

### 4.9.1 Durelių užrakto nuėmimas

1. Atjunkite durelių užrakto kištuką.
2. Atpalaiduokite durelių užraktą.



3. Nuimkite durelių užraktą.



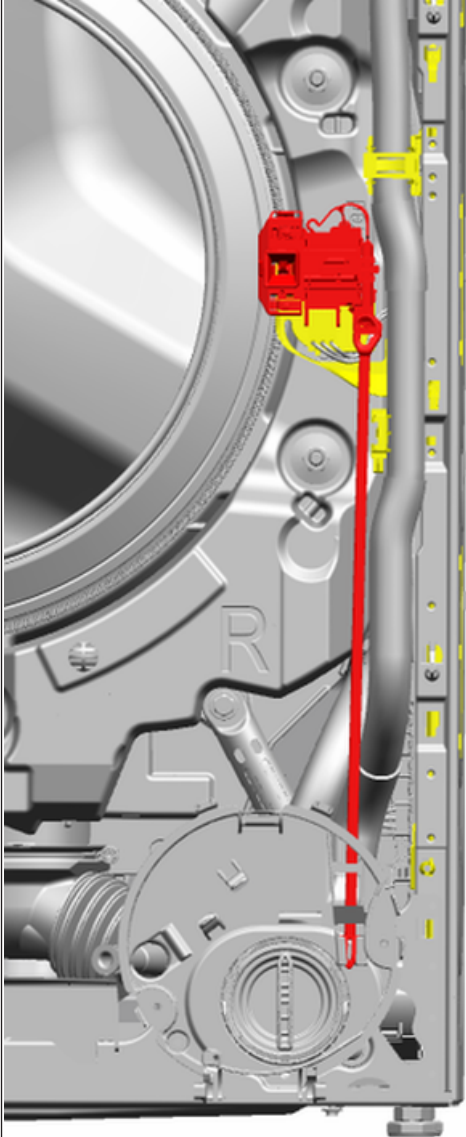

### 4.9.2 Durelių užrakto sumontavimas

Kad būtų užtikrinta prietaiso avarinio durelių atidarymo funkcija, durelių užraktas turi būti teisingoje padėtyje.



- ▶ Uždėkite atvirkščia eilės tvarka.

## 4.10 Būgno apšvietimo keitimas

	<b>ĮSPĖJIMAS</b> <b>Paverstų prietaisų slydimas!</b> Galimi kaulų lūžiai ir prispaudimai ▶ Apsaugokite prietaisus, kad jie nepaslystų.
	<b>PERSPĖJIMAS</b> <b>Aštrios korpuso briaunos!</b> Galima įsijauti ▶ Mūvėkite apsaugines pirštines.
	<b>PERSPĖJIMAS</b> <b>Pavojus, kad atpalaidavus varžtus dalys nukris!</b> Krentančios dalys gali sužeisti. ▶ Apsaugokite konstrukcinę dalį, kad ji nenukristų.
	<b>DĖMESIO!</b> <b>Pavojus, kad atpalaidavus varžtus dalys nukris!</b> Gali būti sugadintos kitos prietaiso dalys arba kliento namai, pvz., grindys. ▶ Apsaugokite konstrukcinę dalį, kad ji nenukristų.

### Reikalavimas.

- ✔ Prietaisas atjungtas nuo maitinimo šaltinio.
- ✔ Prietaisas atjungtas nuo vandens tiekimo.
- ✔ Prietaisai yra laisvai prieinami.
- ✔ [Stalviršis nuimtas.→276](#)
- ✔ [Išimtas skalbiklio stalčius.→277](#)
- ✔ [Antjuostė nuimta.→279](#)

## 4.10.1 Būgno apšvietimo nuėmimas

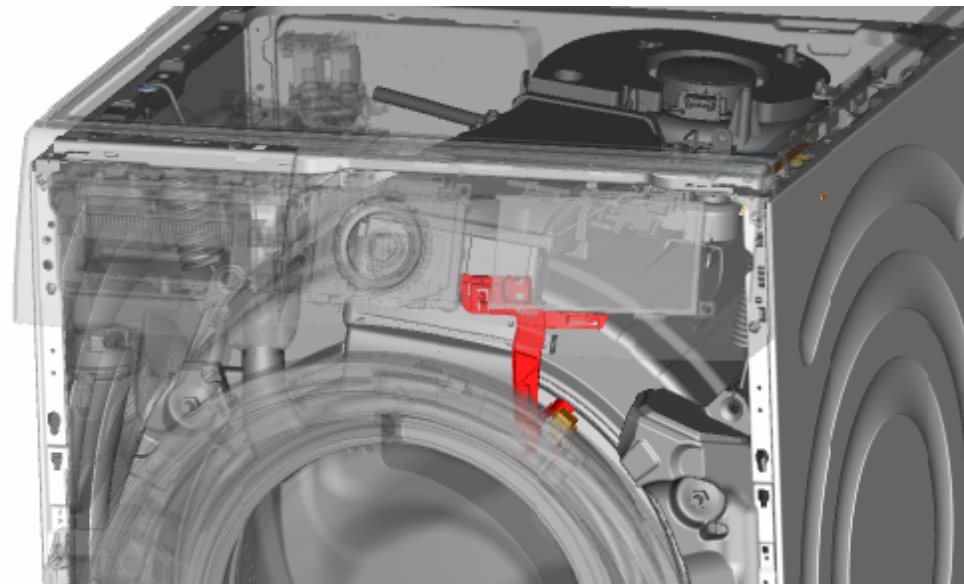

1. Ištraukite būgno apšvietimo laikiklį iš prietaiso.
2. Atjunkite elektros jungtis.
3. Nuimkite būgno apšvietimą nuo apšvietimo laikiklio.

## 4.10.2 Būgno apšvietimo sumontavimas

	Atkreipkite dėmesį į kabelio įmontavimą. Gabelis gali prisispausti.
---	---

- ▶ Uždėkite atvirkščia eilės tvarka.

## 4.11 Priekinio skydo keitimas



### ⚠️ ĮSPĖJIMAS

#### Paverstų prietaisų slydimas!

Galimi kaulų lūžiai ir prispaudimai

- ▶ Apsaugokite prietaisus, kad jie nepaslystų.



### ⚠️ PERSPĖJIMAS

#### Aštrios korpuso briaunos!

Galima įsipjauti

- ▶ Mūvėkite apsaugines pirštines.



### ⚠️ PERSPĖJIMAS

#### Pavojus, kad atpalaidavus varžtus dalys nukris!

Krentančios dalys gali sužeisti.

- ▶ Apsaugokite konstrukcinę dalį, kad ji nenukristų.



### DĖMESIO!

#### Pavojus, kad atpalaidavus varžtus dalys nukris!

Gali būti sugadintos kitos prietaiso dalys arba kliento namai, pvz., grindys.

- ▶ Apsaugokite konstrukcinę dalį, kad ji nenukristų.

### Reikalavimas.

- ✔ Prietaisas atjungtas nuo maitinimo šaltinio.
- ✔ Prietaisas atjungtas nuo vandens tiekimo.
- ✔ Prietaisai yra laisvai prieinami.
- ✔ [Stalviršis nuimtas.→276](#)
- ✔ [Išimtas skalbiklio stalčius.→277](#)
- ✔ [Antjuostė nuimta.→279](#)
- ✔ [Durelės nuimtos.→281](#)
- ✔ [Siurblio dangtelis nuimtas.→283](#)
- ✔ Veržiamasis žiedas nuimtas.
- ✔ Durelių sandariklis priekyje atpalaiduotas.
- ✔ [Būgno apšvietimas nuimtas \(pasirinktis\).→287](#)

## 4.11.1 Priekinio skydo nuėmimas

1. Pakelkite prietaiso priekį.
2. Išsukite apačioje esančius varžtus (1).

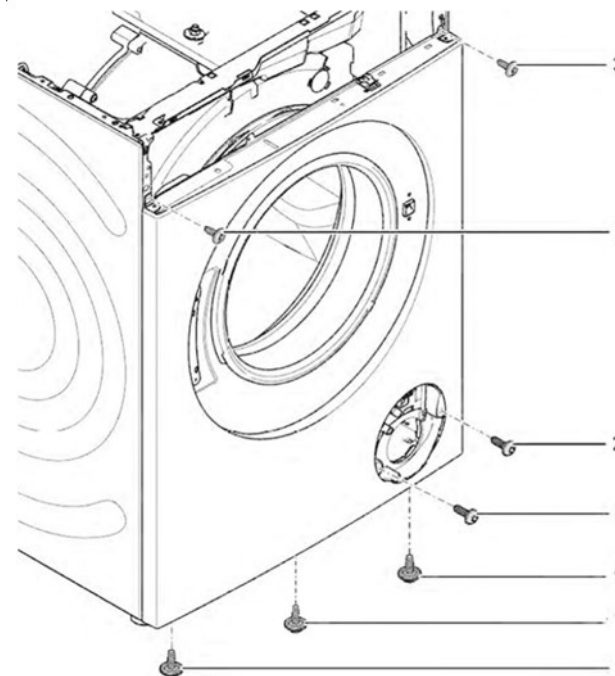

3. Nuleiskite prietaisą.

4. Išsukite priekyje esančius varžtus, pradėdami nuo varžtų apačioje, o tada – viršuje (2, 3).

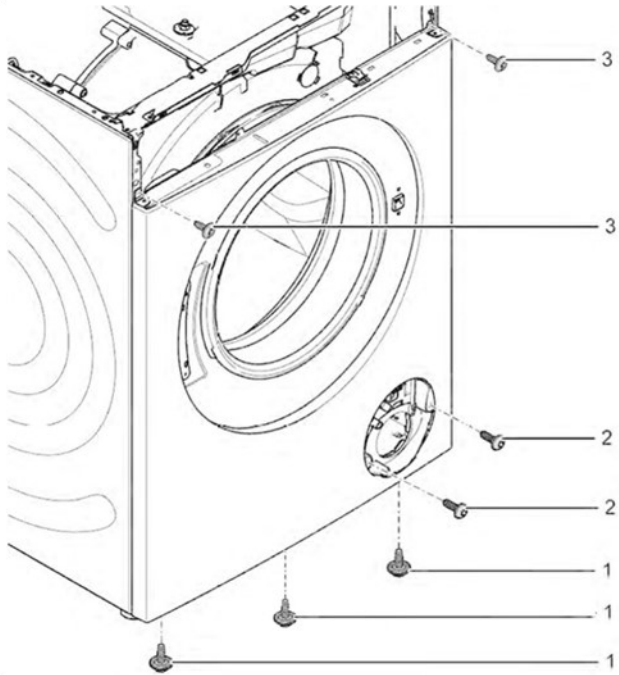

5. Nuimkite priekinį skydą.

### 4.11.2 Priekinio skydo uždėjimas

- ▶ Uždėkite atvirkščia eilės tvarka.

# Reparasjonstips - Vaskemaskin

 <b>Om dette dokumentet</b> .....	<b>291</b>
1.1 Viktig informasjon .....	291
1.1.1 Formål.....	291
1.2 Forklaring av symboler.....	291
1.2.1 Farenivåer .....	291
1.2.2 Faresymboler.....	291
1.2.3 Advarslenes struktur .....	292
1.2.4 Generelle symboler .....	292
 <b>Sikkerhet</b> .....	<b>293</b>
2.1 Generelle sikkerhetsinstruksjoner .....	293
2.1.1 Alle husholdningsapparater .....	293
 <b>Verktøy og hjelpemidler</b> .....	<b>294</b>
 <b>Reparasjon</b> .....	<b>295</b>
4.1 Utskiftning av arbeidsplate .....	295
4.1.1 Demontering av arbeidsplate .....	295
4.1.2 Montering av arbeidsplate .....	295
4.2 Utskiftning av vaskemiddelskuff.....	296
4.2.1 Demontering av vaskemiddelskuff.....	296
4.2.2 Montering av vaskemiddelskuff .....	296
4.3 Utskiftning av håndtak på vaskemiddelskuff .....	297
4.3.1 Demontering av håndtak på vaskemiddelskuff .....	297
4.3.2 Montering av håndtak på vaskemiddelskuff.....	297
4.4 Utskiftning av instrumentpanel.....	298
4.4.1 Demontering av instrumentpanel.....	298
4.4.2 Montering av instrumentpanel .....	299
4.5 Utskiftning av dør .....	300
4.5.1 Demontering av dør .....	300
4.5.2 Montering av dør.....	300
4.6 Utskiftning av dørkomponenter.....	301
4.6.1 Demontering av dørkomponenter.....	301
4.6.2 Montering av dørkomponenter .....	301
4.7 Utskiftning av pumpedeksel.....	302
4.7.1 Demontering av pumpedeksel.....	302
4.7.2 Montering av pumpedeksel.....	302

4.8 Utskiftning av dørpakning .....	303
4.8.1 Demontering av dørpakning .....	303
4.8.2 Montering av dørpakning .....	303
4.9 Utskiftning av dørlås.....	304
4.9.1 Demontering av dørlås.....	304
4.9.2 Montering av dørlås .....	305
4.10 Utskiftning av lampe i trommel .....	306
4.10.1 Demontering av lampe i trommel .....	306
4.10.2 Montering av lampe i trommel .....	306
4.11 Utskiftning av frontpanel .....	307
4.11.1 Demontering av frontpanel .....	307
4.11.2 Montering av frontpanel .....	308

# i Om dette dokumentet

## 1.1 Viktig informasjon

### 1.1.1 Formål

Disse tipsene om reparasjon skal hjelpe kunden til selv å kunne reparere apparater i samsvar med gjeldende regulering av øko-design (med gyldighet 03/2021).





De inneholder informasjon om hvordan definerte reservedeler skiftes, inklusive advarsler og risikoer.

Kontakt vår kundeservice dersom du har spørsmål. Vi påtar oss kun ansvar for skader dersom tipsene om reparasjon er korrekt fulgt.

## 1.2 Forklaring av symboler

### 1.2.1 Farenivåer

Advarslene som viser farenivå, består av et symbol og et signalord. Signalordet viser hvor alvorlig faren er.





Advarsel som viser farenivå	Betydning
	Dersom advarselen ignoreres, vil det føre til død eller alvorlige personskader.
	Dersom advarselen ignoreres, kan det føre til død eller alvorlige personskader.
	Dersom advarselen ignoreres, kan det føre til mindre personskader.
	Dersom advarselen ignoreres, kan det føre til materiell skade.

Tabell 1: Farenivåer



### 1.2.2 Faresymboler

Faresymboler er symbolske fremstillinger som gir en indikasjon av hvilken type fare det dreier seg om.

Følgende faresymboler brukes i dette dokumentet:

Faresymbol	Betydning
	Generell advarsel
	Fare for elektrisk støt
	Eksplisjonsfare
	Fare for å skjære seg
	Klemfare



## i Om dette dokumentet

Faresymbol	Betydning
	Fare på grunn av varme overflater
	Fare på grunn av sterkt magnetfelt
	Fare fra ikke-ioniserende stråling



Tabell 2: Faresymboler

### 1.2.3 Advarslenes struktur

Advarslene i dette dokumentet har standardisert utseende og standardisert struktur.



	<div style="background-color: red; color: white; padding: 2px; text-align: center;">  <b>FARE</b> </div> <p><b>Faretype og kilde til fare!</b>            Mulige konsekvenser dersom fare/advarsel ignoreres.</p> <ul style="list-style-type: none"> <li>▶ Tiltak og forbud for å forebygge fare.</li> </ul>
--	---





Eksemplet nedenfor viser en advarsel mot elektrisk støt på grunn av strømførende deler. Tiltaket for å unngå faren er angitt.

	<div style="background-color: red; color: white; padding: 2px; text-align: center;">  <b>FARE</b> </div> <p><b>Fare for elektrisk støt på grunn av strømførende deler!</b>            Død på grunn av drepende elektrisk støt</p> <ul style="list-style-type: none"> <li>▶ Koble apparatene fra strømforsyningen i minst 60 sekunder før reparasjonene startes.</li> </ul>
---	---

### 1.2.4 Generelle symboler

Følgende generelle symboler brukes i dette dokumentet:

Gen. symbol	Betydning
	Identifisering av et spesielt tips (tekst og/eller grafikk)
	Identifisering av et enkelt tips (kun tekst)
	Identifisering av en lenke til en opplæringsvideo

Gen. symbol	Betydning
	Identifisering av nødvendig verktøy
	Identifisering av nødvendige forutsetninger
	Identifisering av en betingelse (hvis ..., så ...)
	Identifisering av et resultat
[Start]	Identifisering av en tast eller knapp
[00123456]	Identifisering av et materialnummer
Status	Identifisering av vist tekst/vindu (i apparatets display)

Tabell 3: Generelle symboler

## 2.1 Generelle sikkerhetsinstruksjoner

### 2.1.1 Alle husholdningsapparater

#### **Fare for elektrisk støt på grunn av strømførende deler!**

- Feil ved reparasjoner hvor elektriske komponenter er involvert, kan føre til elektrisk støt!
- Koble apparatet fra strømmettet i minst 60 sekunder før arbeidet startes.
- Etter reparasjonen må du sørge for at det utføres en sikkerhetstest iht. VDE 0701 eller gjeldende forskrifter i det respektive land.

#### **Fare for personskade på grunn av skarpe kanter!**

- Bruk vernehansker.

#### **Fare for å knuse legemsdeler under reparasjoner, vedlikehold, feilsøking og service på grunn av tunge og bevegelige komponenter**

- Bruk vernesko.
- Sikre tunge komponenter for å hindre at de faller ned.
- Ikke stikk kroppsdelene inn i bevegelige komponenter.







#### **Fare for apparatets sikkerhet/funksjon!**





- Bruk kun originale reservedeler.

#### **Fare for skade på deler som er følsomme overfor elektrostatisk utlading (ESD)!**

- Ikke berør modulene, inklusive tilkoblinger og ledere.

## Verktøy og hjelpemidler

Betegnelse	Detaljer	Bilder
Hjelpeverktøy [15000155]	Verktøy for å løsne plastdeler	
Torx T20-skrutrekker med borehull [00340764]	100 mm, for skruer med splint	
Momentnøkkel [15000441]	Momentnøkkel 20 - 100 Nm	
Flat skrutrekker [00340854]	Blad 3,5 mm x 0,6 mm x 100 mm, beskyttende isolasjon 1000 V AC	
Flat skrutrekker [00340855]	Blad 5,5 mm x 1,0 mm x 125 mm, beskyttende isolasjon 1000 V AC	
Spisstang, vinkelmonster [00341269]	Lengde 200 mm	
Avbitertang [00342182]	Lengde: 200 mm	



Betegnelse	Detaljer	Bilder
Fastnøkkel [00340811]	Størrelse på fastnøkkel 10°mm, M6	
Combination wrench [00340814]	Størrelse på fastnøkkel 13°mm, M8	
Fastnøkkel [00340817]	Størrelse på fastnøkkel 17 mm, M10	
Fastnøkkel [15000459]	Størrelse på fastnøkkel 16°mm, M10	

## 4.1 Utskiftning av arbeidsplate

### Spesielle hjelpemidler:

-  Torx-bits TX20 med hull      Lengde 152 mm, nyttbar      [00341272]  
lengde 124 mm, 1/4" sekskantdrev  
(6,35 mm), for skruer med splint

### Forutsetning:

-  Apparatet kobles fra strømforsyningen.
-  Apparatet kobles fra vannforsyningen.

### 4.1.1 Demontering av arbeidsplate

- ▶ 1. Fjern skruene (1).
- 2. Skyv arbeidsplaten til baksiden av apparatet (2).
- 3. Beveg arbeidsplaten opp (3) for å fjerne den.

### 4.1.2 Montering av arbeidsplate



Hold øye med monteringen av kabelen. Kabelen kan sitte fast.

- ▶ Monteres i motsatt rekkefølge.

## 4.2 Utskiftning av vaskemiddelskuff

### Forutsetning:

- ✓ Apparatet kobles fra strømforsyningen.
- ✓ Apparatet kobles fra vannforsyningen.

### 4.2.1 Demontering av vaskemiddelskuff

1. Trekk ut vaskemiddelskuffen.
2. 1. Trykk innsatsen ned (1).  
2. Ta ut vaskemiddelskuffen (2).

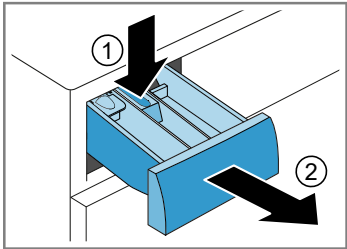

### 4.2.2 Montering av vaskemiddelskuff

- ▶ Monteres i motsatt rekkefølge.

## 4.3 Utskiftning av håndtak på vaskemiddelskuff

### Forutsetning:

- ✓ Apparatet kobles fra strømforsyningen.
- ✓ Apparatet kobles fra vannforsyningen.
- ✓ [Vaskemiddelskuffen er tatt ut. →296](#)

### 4.3.1 Demontering av håndtak på vaskemiddelskuff

1. Løsne låselementene.

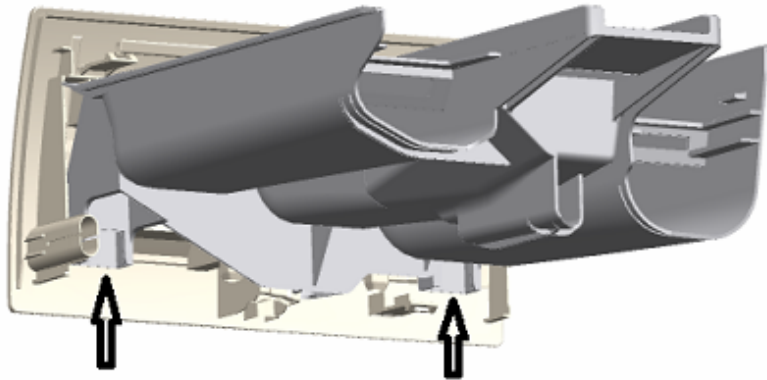





2. Demonter håndtaket på vaskemiddelskuffen.

### 4.3.2 Montering av håndtak på vaskemiddelskuff

- ▶ Monteres i motsatt rekkefølge.

## 4.4 Utskiftning av instrumentpanel

I egenskap av produsent er vi forpliktet til å stille til rådighet for forbrukerne reservedelen instrumentpanel inkl. reparasjonsveiledning i samsvar med direktiv (EU) 2019/2023. Men vi vil gjøre oppmerksom på at en kvalifisert elektriker etter utskiftning av et instrumentpanel må utføre en elektroteknisk sikkerhetstest før apparatet tas i bruk. Denne personen må kunne dokumentere at hun/han er kvalifisert i henhold til gjeldende lover, forskrifter og standarder i det respektive land.

	<p style="text-align: center;"><b>FARE</b></p> <p><b>Fare for elektrisk støt på grunn av strømførende deler!</b> Livsfare på grunn av elektrisk støt ved feil reparasjon</p> <ul style="list-style-type: none"> <li>▶ Elektriske deler skal repareres av kvalifiserte elektrikere.</li> <li>▶ Etter reparasjonen må du sørge for at det utføres en sikkerhetstest iht. VDE 0701 eller gjeldende forskrifter i det respektive land.</li> </ul>
	<p style="text-align: center;"><b>ADVARSEL</b></p> <p><b>Tiltede apparater kan skli ut!</b> Beinbrudd/klemskader</p> <ul style="list-style-type: none"> <li>▶ Sikre apparatene mot å skli ut.</li> </ul>
	<p style="text-align: center;"><b>FORSIKTIG</b></p> <p><b>Skarpe kanter på hus!</b> Kuttskader</p> <ul style="list-style-type: none"> <li>▶ Bruk vernehansker.</li> </ul>
	<p style="text-align: center;"><b>FORSIKTIG</b></p> <p><b>Fare for at deler kan falle ned på grunn av løsnede skruer!</b> Personskade på grunn av fallende deler.</p> <ul style="list-style-type: none"> <li>▶ Sikre komponenten så den ikke kan falle ned.</li> </ul>
	<p style="text-align: center;"><b>OBS!</b></p> <p><b>Fare for at deler kan falle ned på grunn av løsnede skruer!</b> Skade på andre deler på apparatet eller i kundens hjem, f.eks. gulv.</p> <ul style="list-style-type: none"> <li>▶ Sikre komponenten så den ikke kan falle ned.</li> </ul>

### Forutsetning:

- ✓ Apparatet kobles fra strømforsyningen.
- ✓ Apparatet kobles fra vannforsyningen.

- ✓ [Arbeidsplaten er demontert. →295](#)
- ✓ [Vaskemiddelskuffen er tatt ut. →296](#)

### 4.4.1 Demontering av instrumentpanel

1. Fjern skruene (1).
2. Løsne låselementene (2, 3).

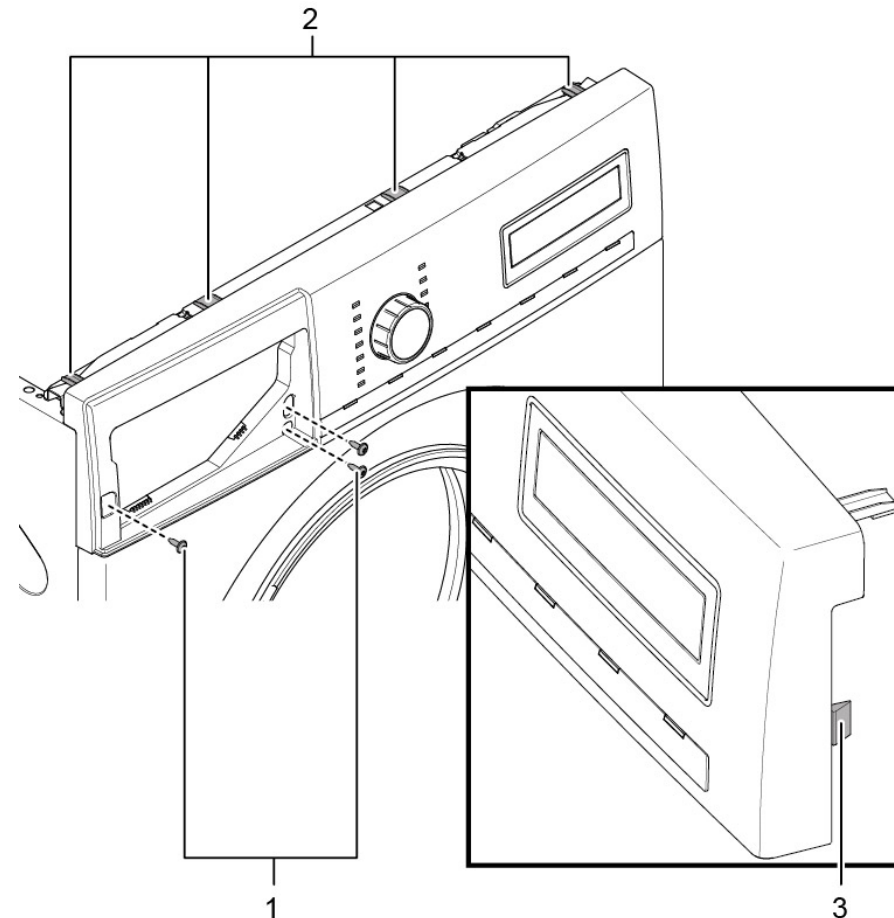

2. Løsne kontrollenhetens pluggkontakt.
3. Demonter instrumentpanelet.

### 4.4.2 Montering av instrumentpanel



Hold øye med monteringen av kabelen. Kabelen kan sitte fast.

- ▶ Monteres i motsatt rekkefølge.

## 4.5 Utskiftning av dør



### ⚠️ FORSIKTIG

#### Åpent hengsleområde!

Fare for å knuse/sette fast fingre

- ▶ Ikke grip inn i hengsleområdet.
- ▶ Bruk vernehansker.



### ⚠️ FORSIKTIG

#### Fare for at deler kan falle ned på grunn av løsnede skruer!

Personskade på grunn av fallende deler.

- ▶ Sikre komponenten så den ikke kan falle ned.



### OBS!

#### Fare for at deler kan falle ned på grunn av løsnede skruer!

Skade på andre deler på apparatet eller i kundens hjem, f.eks. gulv.

- ▶ Sikre komponenten så den ikke kan falle ned.

#### Forutsetning:

- ✔️ Apparatet kobles fra strømforsyningen.
- ✔️ Apparatet kobles fra vannforsyningen.
- ✔️ Døren er åpen.

### 4.5.1 Demontering av dør

1. Fjern skruene (1).

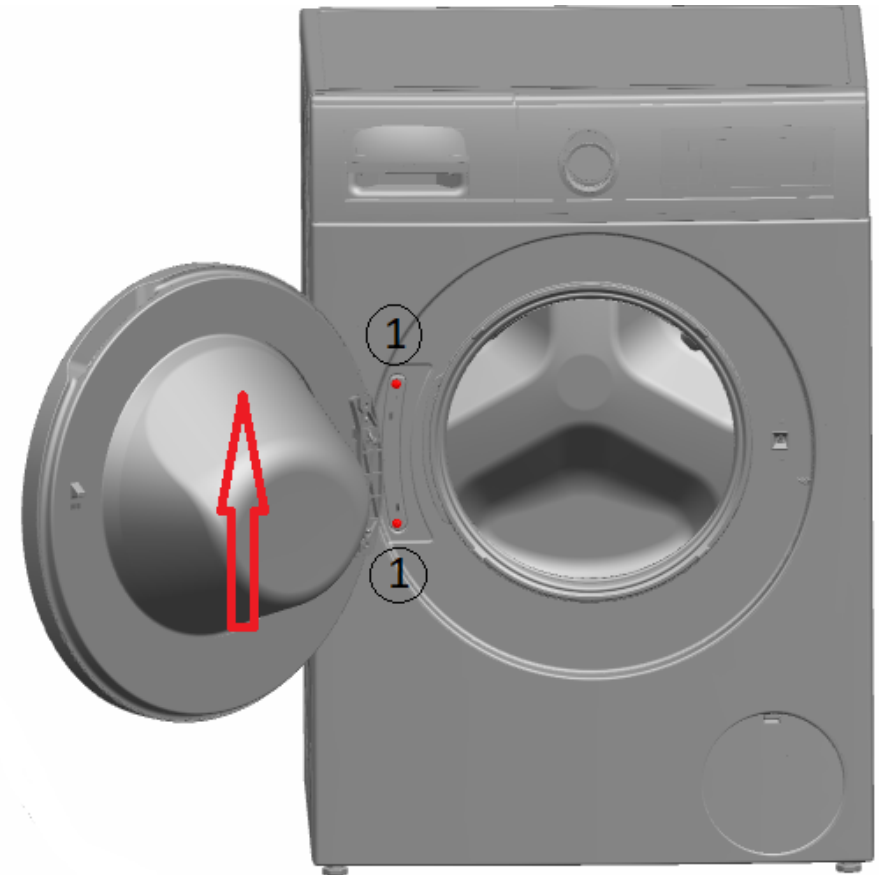

2. Ta ut døren mot oppsiden.

### 4.5.2 Montering av dør

- ▶ Monteres i motsatt rekkefølge.

## 4.6 Utskiftning av dørkomponenter

	<b>⚠ ADVARSEL</b>
	<b>Tunge og bevegelige komponenter!</b> Fare for å knuse legemsdeler under reparasjoner, vedlikehold, feilsøking og service <ul style="list-style-type: none"><li>▶ Bruk vernesko.</li><li>▶ Sikre tunge komponenter for å hindre at de faller ned.</li><li>▶ Ikke stikk kroppsdeler inn i bevegelige komponenter.</li></ul>

	<b>⚠ FORSIKTIG</b>
	<b>Åpent hengsleområde!</b> Fare for å knuse/sette fast fingre <ul style="list-style-type: none"><li>▶ Ikke grip inn i hengsleområdet.</li><li>▶ Bruk vernehansker.</li></ul>

### Forutsetning:

- ✓ Apparatet kobles fra strømforsyningen.
- ✓ Apparatet kobles fra vannforsyningen.
- ✓ [Døren er demontert.→300](#)

### 4.6.1 Demontering av dørkomponenter

- ▶ Ta døren fra hverandre fra utsiden til innsiden.

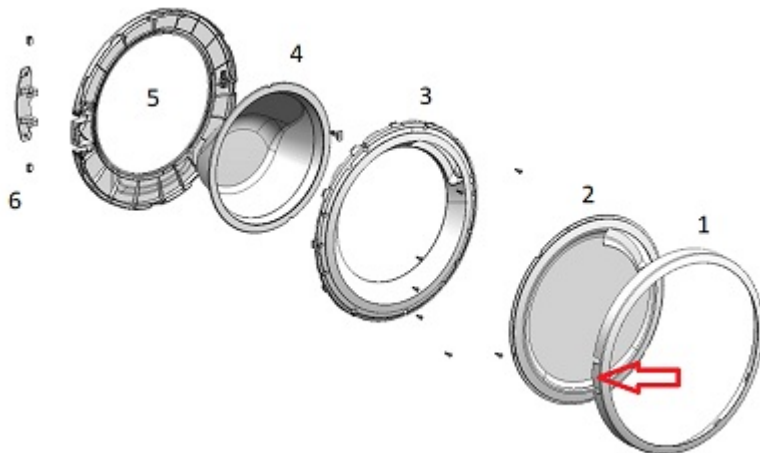

### 4.6.2 Montering av dørkomponenter

- ▶ Monteres i motsatt rekkefølge.

## 4.7 Utskiftning av pumpedeksel

### Forutsetning:

- ✓ Apparatet kobles fra strømforsyningen.
- ✓ Apparatet kobles fra vannforsyningen.

### 4.7.1 Demontering av pumpedeksel

1. Åpne pumpedekslet.

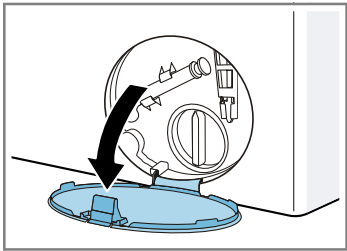

2. Ta av pumpedekslet.

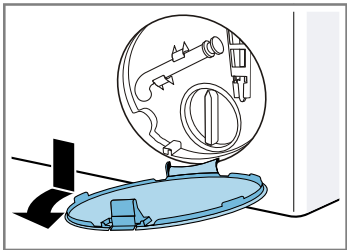

### 4.7.2 Montering av pumpedeksel

- ▶ Monteres i motsatt rekkefølge.

## 4.8 Utskiftning av dørpakning



### FORSIKTIG

**Skarpe kanter på hus!**  
Kuttskader  
► Bruk vernehansker.



### FORSIKTIG

**Fare for at deler kan falle ned på grunn av løsnede skruer!**  
Personskade på grunn av fallende deler.  
► Sikre komponenten så den ikke kan falle ned.



### OBS!

**Fare for at deler kan falle ned på grunn av løsnede skruer!**  
Skade på andre deler på apparatet eller i kundens hjem, f.eks. gulv.  
► Sikre komponenten så den ikke kan falle ned.

### Forutsetning:

- ✓ Apparatet kobles fra strømforsyningen.
- ✓ Apparatet kobles fra vannforsyningen.
- ✓ Apparatet er fritt tilgjengelig.
- ✓ [Arbeidsplaten er demontert.→295](#)
- ✓ [Vaskemiddelskuffen er tatt ut.→296](#)
- ✓ [Instrumentpanelet er demontert.→298](#)
- ✓ [Døren er demontert.→300](#)
- ✓ [Pumpedekslet er fjernet.→302](#)
- ✓ [Frontpanelet er demontert.→307](#)
- ✓ [Drum Light er demontert \(alternativ\).→306](#)

## 4.8.1 Demontering av dørpakning

1. Løsne alle slangekoblingene.

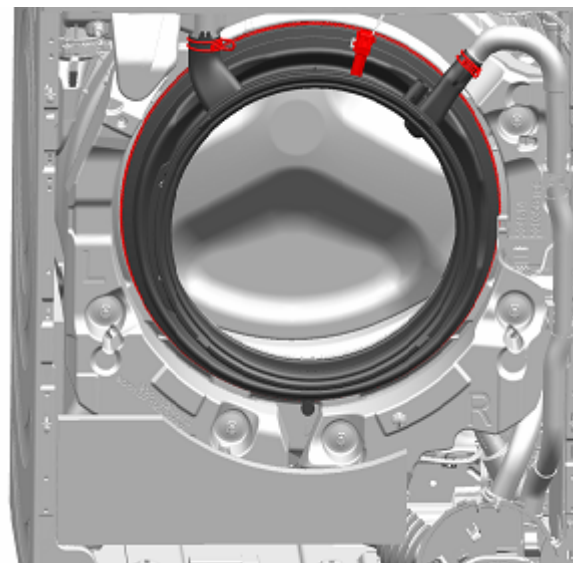

2. Demonter dørpakningen.

## 4.8.2 Montering av dørpakning







### ADVARSEL

**Fare for at deler kan falle ned på grunn feil montering!**  
Personskade eller skade på apparatet.  
► Trekk til gummipakningens stramming med 3,4 Nm.

- Monteres i motsatt rekkefølge.

## 4.9 Utskiftning av dørlås

Egenskap av produsent er vi forpliktet til å stille til rådighet for forbrukerne reserve- delen dørlås inkl. reparasjonsveiledning i samsvar med direktiv (EU) 2019/2023. Men vi vil gjøre oppmerksom på at en kvalifisert elektriker må utføre en elektroteknisk sikkerhetstest før apparatet tas i bruk etter utskiftning av en dørlås. Denne personen må kunne dokumentere at hun/han er kvalifisert i henhold til gjeldende lover, forskrifter og standarder i det respektive land.

	<p><b>FARE</b></p> <p><b>Fare for elektrisk støt på grunn av strømførende deler!</b> Livsfare på grunn av elektrisk støt ved feil reparasjon</p> <ul style="list-style-type: none"><li>▶ Elektriske deler skal repareres av kvalifiserte elektrikere.</li><li>▶ Etter reparasjonen må du sørge for at det utføres en sikkerhetstest iht. VDE 0701 eller gjeldende forskrifter i det respektive land.</li></ul>
	<p><b>ADVARSEL</b></p> <p><b>Tiltede apparater kan skli ut!</b> Beinbrudd/klemskader</p> <ul style="list-style-type: none"><li>▶ Sikre apparatene mot å skli ut.</li></ul>
	<p><b>FORSIKTIG</b></p> <p><b>Skarpe kanter på hus!</b> Kuttskader</p> <ul style="list-style-type: none"><li>▶ Bruk vernehansker.</li></ul>
	<p><b>FORSIKTIG</b></p> <p><b>Fare for at deler kan falle ned på grunn av løsnede skruer!</b> Personskade på grunn av fallende deler.</p> <ul style="list-style-type: none"><li>▶ Sikre komponenten så den ikke kan falle ned.</li></ul>
	<p><b>OBS!</b></p> <p><b>Fare for at deler kan falle ned på grunn av løsnede skruer!</b> Skade på andre deler på apparatet eller i kundens hjem, f.eks. gulv.</p> <ul style="list-style-type: none"><li>▶ Sikre komponenten så den ikke kan falle ned.</li></ul>

### Forutsetning:

- ✓ Apparatet kobles fra strømforsyningen.
- ✓ Apparatet kobles fra vannforsyningen.

- ✓ Apparatet er fritt tilgjengelig.
- ✓ [Arbeidsplaten er demontert.→295](#)
- ✓ [Vaskemiddelskuffen er tatt ut.→296](#)
- ✓ [Instrumentpanelet er demontert.→298](#)
- ✓ [Døren er demontert.→300](#)
- ✓ Strammeringen er demontert.
- ✓ [Dørpakningen er demontert.→303](#)
- ✓ [Pumpedekslet er fjernet.→302](#)
- ✓ [Frontpanelet er demontert.→307](#)

### 4.9.1 Demontering av dørlås

1. Koble fra dørens låseplugg.
2. Løsne dørlåsen.



3. Demonter dørlåsen.

### 4.9.2 Montering av dørlås

Dørlåsen må være i korrekt posisjon for å sikre nødfunksjonen for åpning av døren på apparatet.

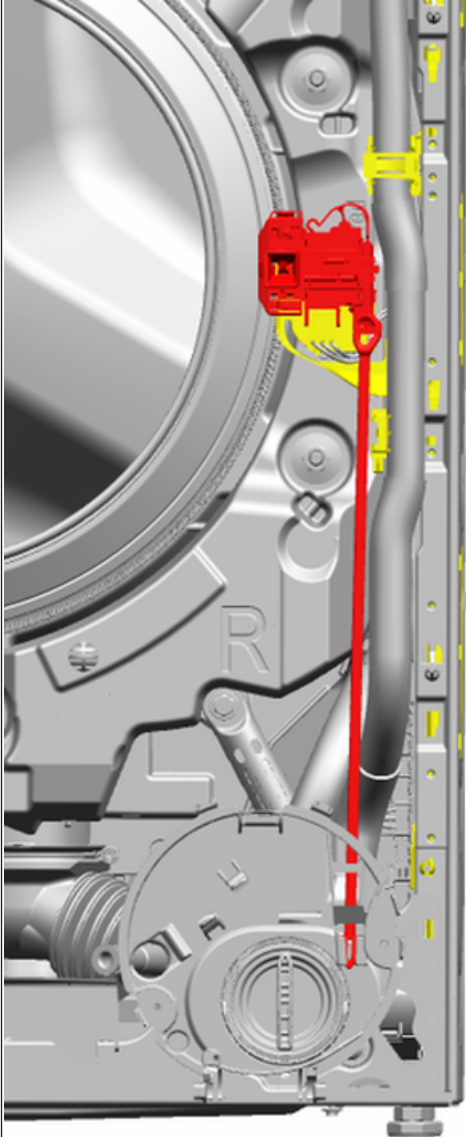

- ▶ Monteres i motsatt rekkefølge.

## 4.10 Utskiftning av lampe i trommel



### ADVARSEL

**Tiltede apparater kan skli ut!**  
Beinbrudd/klemskader  
▶ Sikre apparatene mot å skli ut.



### FORSIKTIG

**Skarpe kanter på hus!**  
Kuttskader  
▶ Bruk vernehansker.



### FORSIKTIG

**Fare for at deler kan falle ned på grunn av løsnede skruer!**  
Personskade på grunn av fallende deler.  
▶ Sikre komponenten så den ikke kan falle ned.



### OBS!

**Fare for at deler kan falle ned på grunn av løsnede skruer!**  
Skade på andre deler på apparatet eller i kundens hjem, f.eks. gulv.  
▶ Sikre komponenten så den ikke kan falle ned.

#### Forutsetning:

- ✓ Apparatet kobles fra strømforsyningen.
- ✓ Apparatet kobles fra vannforsyningen.
- ✓ Apparatet er fritt tilgjengelig.
- ✓ [Arbeidsplaten er demontert.→295](#)
- ✓ [Vaskemiddelskuffen er tatt ut.→296](#)
- ✓ [Instrumentpanelet er demontert.→298](#)

## 4.10.1 Demontering av lampe i trommel

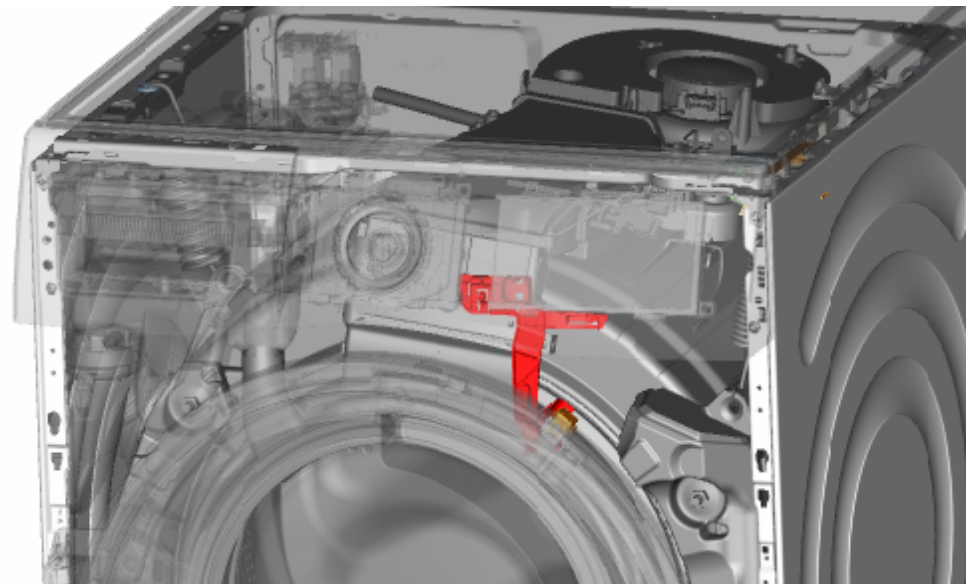

1. Trekk trommellampeholderen ut av apparatet.
2. Koble fra de elektriske tilkoblingene.
3. Demonter trommellampen fra trommellampeholderen.

## 4.10.2 Montering av lampe i trommel





Hold øye med monteringen av kabelen. Kabelen kan sitte fast.

- ▶ Monteres i motsatt rekkefølge.

## 4.11 Utskiftning av frontpanel

	<b>⚠ ADVARSEL</b> <b>Tiltede apparater kan skli ut!</b> Beinbrudd/klemskader ▶ Sikre apparatene mot å skli ut.
--	---

	<b>⚠ FORSIKTIG</b> <b>Skarpe kanter på hus!</b> Kuttskader ▶ Bruk vernehansker.
--	--

	<b>⚠ FORSIKTIG</b> <b>Fare for at deler kan falle ned på grunn av løsnede skruer!</b> Personskade på grunn av fallende deler. ▶ Sikre komponenten så den ikke kan falle ned.
--	---

	<b>OBS!</b> <b>Fare for at deler kan falle ned på grunn av løsnede skruer!</b> Skade på andre deler på apparatet eller i kundens hjem, f.eks. gulv. ▶ Sikre komponenten så den ikke kan falle ned.
--	---

### Forutsetning:

- ✓ Apparatet kobles fra strømforsyningen.
- ✓ Apparatet kobles fra vannforsyningen.
- ✓ Apparatet er fritt tilgjengelig.
- ✓ [Arbeidsplaten er demontert.→295](#)
- ✓ [Vaskemiddelskuffen er tatt ut.→296](#)
- ✓ [Instrumentpanelet er demontert.→298](#)
- ✓ [Døren er demontert.→300](#)
- ✓ [Pumpedeckslet er fjernet.→302](#)
- ✓ Stramringen er demontert.
- ✓ Dørpakningen er løsnet foran.
- ✓ [Drum Light er demontert \(alternativ\).→306](#)

### 4.11.1 Demontering av frontpanel

1. Løft opp apparatet foran.

2. Fjern skruene nederst (1).

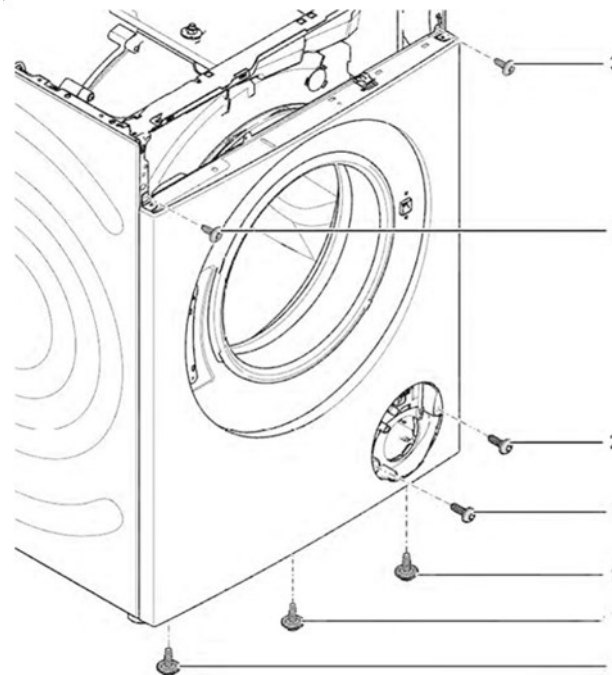

3. Senk apparatet ned.

## Reparasjon

4. Fjern skruene på fronten; nedenfra og opp (2, 3).

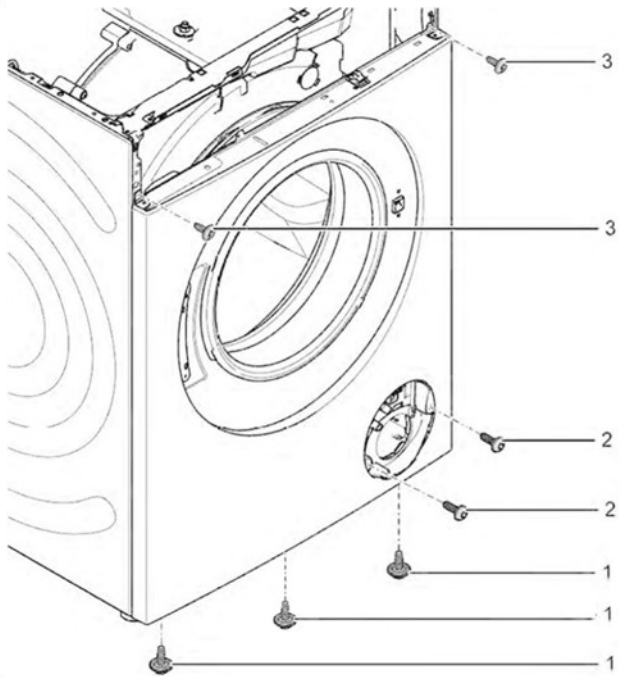

5. Demonter frontpanelet.

### 4.11.2 Montering av frontpanel

- ▶ Monteres i motsatt rekkefølge.

# Wskazówki naprawy - Pralka

## Informacje dotyczące dokumentu ..... 310

1.1	Ważne informacje.....	310
1.1.1	Cel dokumentu .....	310
1.2	Objaśnienie symboli ostrzegawczych.....	310
1.2.1	Oznaczenie poziomów niebezpieczeństwa .....	310
1.2.2	Symbole ostrzegawcze.....	310
1.2.3	Budowa ostrzeżeń .....	311
1.2.4	Ogólne symbole.....	311

## Bezpieczeństwo..... 312

2.1	Ogólne informacje dotyczące bezpieczeństwa.....	312
2.1.1	Wszystkie sprzęty gospodarstwa domowego .....	312

## Narzędzia i pomoce techniczne..... 313

## Naprawy..... 314

4.1	Wymiana blatu roboczego.....	314
4.1.1	Demontaż blatu roboczego .....	314
4.1.2	Montaż blatu roboczego .....	314
4.2	Wymiana dozownika detergentu.....	315
4.2.1	Demontaż dozownika detergentu .....	315
4.2.2	Montaż dozownika detergentu .....	315
4.3	Wymiana uchwyty dozownika detergentu.....	316
4.3.1	Demontaż uchwyty dozownika detergentu.....	316
4.3.2	Montaż uchwyty dozownika detergentu .....	316
4.4	Wymiana panelu przedniego .....	317
4.4.1	Demontaż panelu przedniego .....	318
4.4.2	Montaż panelu przedniego.....	318
4.5	Wymiana drzwi.....	319
4.5.1	Demontaż drzwi .....	319
4.5.2	Montaż drzwi .....	319
4.6	Wymiana komponentów drzwiczek .....	320
4.6.1	Demontaż komponentów drzwiczek .....	320
4.6.2	Montaż komponentów drzwiczek.....	320
4.7	Wymiana osłony pompy .....	321
4.7.1	Demontaż osłony pompy .....	321
4.7.2	Montaż osłony pompy .....	321

4.8	Wymiana uszczelki drzwi.....	322
4.8.1	Demontaż uszczelki drzwi .....	322
4.8.2	Montaż uszczelki drzwi .....	322
4.9	Wymiana blokady drzwi.....	323
4.9.1	Demontaż blokady drzwi .....	323
4.9.2	Montaż blokady drzwi .....	324
4.10	Wymiana oświetlenia bębna .....	326
4.10.1	Demontaż oświetlenia bębna .....	326
4.10.2	Montaż oświetlenia bębna.....	326
4.11	Wymiana ściany przedniej .....	327
4.11.1	Demontaż ściany przedniej .....	327
4.11.2	Montaż ściany przedniej.....	328

# **i** Informacje dotyczące dokumentu

## 1.1 Ważne informacje

### 1.1.1 Cel dokumentu

Niniejsze wskazówki naprawcze mają na celu zapewnienie użytkownikowi pomocy w samodzielnej naprawie posiadanych urządzeń w sposób zgodny z obowiązującymi przepisami w sprawie ekoprojektu (stan na 03/2021).

Zawierają one informacje na temat wymiany określonych części zamiennych oraz ostrzeżenia i informacje o zagrożeniach.

W razie pytań należy się skontaktować z naszym działem serwisowym. Odpowiedzialność za szkody ponosimy tylko pod warunkiem prawidłowego stosowania się do wskazówek naprawczych.

## 1.2 Objasnienie symboli ostrzegawczych

### 1.2.1 Oznaczenie poziomów niebezpieczeństwa

Poziom ryzyka jest określany przy pomocy symbolu oraz wyrazu. Wyraz określa poziom ryzyka.



Symbol	Znaczenie
 <b>NIEBEZPIECZEŃSTWO</b>	Bezpośrednio zagrażające niebezpieczeństwo, które przy niezachowaniu odpowiednich środków ostrożności może doprowadzić do śmierci lub poważnych obrażeń.
 <b>OSTRZEŻENIE</b>	Prawdopodobieństwo wystąpienia niebezpieczeństwa, które przy niezachowaniu odpowiednich środków ostrożności może doprowadzić do śmierci lub poważnych obrażeń.
 <b>WAŻNE</b>	Prawdopodobieństwo wystąpienia niebezpieczeństwa, które przy niezachowaniu odpowiednich środków ostrożności może doprowadzić do powstania lekkich obrażeń.
<b>UWAGA!</b>	Ostrzeżenie dot. możliwości powstania szkody materialnej.

Tabela 1: Oznaczenie poziomów niebezpieczeństwa

### 1.2.2 Symbole ostrzegawcze

Symbole ostrzegawcze reprezentują graficznie źródło potencjalnego ryzyka.

W poniższym dokumencie użyto następujących symboli:

Symbole ostrzegawcze	Znaczenie
	Ogólne ostrzeżenie
	Niebezpieczeństwo od napięcia elektrycznego
	Ryzyko wybuchu

## **i** Informacje dotyczące dokumentu







Symbole ostrzegawcze	Znaczenie
	Ryzyko obrażeń (rozcięć)
	Ryzyko zmiążdżenia
	Ryzyko oparzenia
	Silne pole magnetyczne
	Promieniowanie nie-jonizujące

Tabela 2: Symbole ostrzegawcze

### 1.2.3 Budowa ostrzeżeń

Ostrzeżenia podane w dokumencie mają standardową budowę.

	<p><b>⚠ NIEBEZPIECZEŃSTWO</b></p> <p><b>Typ i źródło ryzyka!!</b> Konsekwencje zignorowania.</p> <ul style="list-style-type: none"> <li>▶ Środki ochronne.</li> </ul>
---	---

Kolejne ostrzeżenie wskazuje, jako źródło możliwość porażenia prądem. Wskazano czynności, które mają za zadanie ograniczenie ryzyka.

	<p><b>⚠ NIEBEZPIECZEŃSTWO</b></p> <p><b>Ryzyko porażenia prądem, ze względu na elementy będące pod napięciem!</b> Zagrożenie życia poprzez porażenie prądem</p> <ul style="list-style-type: none"> <li>▶ Odłączyć urządzenie od zasilania sieciowego na 60 sekund przed rozpoczęciem naprawy.</li> </ul>
--	--

### 1.2.4 Ogólne symbole

Poniższe symbole są używane w dokumentacji:







Symbol	Znaczenie
	Identyfikacja specjalnej wskazówki (tekst lub grafika)
	Identyfikacja prostej wskazówki (tylko tekst)
	Identyfikacja linku do pliku wideo
	Identyfikacja narzędzi
	Identyfikacja wstępnych warunków
	Identyfikacja warunku (jeżeli)
	Identyfikacja rezultatu
[Start]	Identyfikacja przycisku
[00123456]	Identyfikacja numeru materiału
Status	Identyfikacja wyświetlanego tekstu / komunikatu (na wyświetlaczu)

Tabela 3: Ogólne symbole

## **2.1 Ogólne informacje dotyczące bezpieczeństwa**

### **2.1.1 Wszystkie sprzęty gospodarstwa domowego**

#### **Ryzyko porażenia prądem elektrycznym wskutek kontaktu z elementami znajdującymi się pod napięciem!**

- Błędna naprawa części elektrycznych może spowodować porażenie prądem elektrycznym!
- Co najmniej 60 sekund przed przystąpieniem do pracy odłączyć urządzenie od sieci elektrycznej.
- Po naprawie należy przeprowadzić test bezpieczeństwa zgodny z przepisami normy VDE 0701 (Niemcy) lub odpowiednimi przepisami obowiązującymi w kraju użytkowania.

#### **Ryzyko zranienia o ostre krawędzie!**

- Używać rękawic ochronnych.

#### **Ryzyko zmiążdżenia podczas naprawy, obsługi lub diagnozy, ze względu na ciężkie i ruchome elementy**

- Stosować obuwie ochronne.
- Zabezpieczyć ciężkie elementy przed upadkiem.
- Nie dotykać ruchomych elementów podczas pracy urządzenia.







#### **Zagrożenie dla bezpieczeństwa użytkownika i działania urządzenia!**





- Używać tylko oryginalnych części zamiennych.

#### **Ryzyko uszkodzenia komponentów wrażliwych na wyładowania elektrostatyczne (ESD)!**

- Nie dotykać modułów, włącznie ze złączami i ścieżkami przewodzącymi.

## Narzędzia i pomoce techniczne

Przeznaczenie	Detale	Zdjęcia
Narzędzie pomocnicze [15000155]	Narzędzie do poluzowania plastikowych części	
Śrubokręt typu Torx T20 z gniazdem [00340764]	100 mm, do wkrętów z trzpieniem zabezpieczającym	
Klucz dynamometryczny [15000441]	Klucz dynamometryczny 20 - 100 Nm	
Śrubokręt z końcówką płaską [00340854]	Końcówka 3,5 mm x 0,6 mm x 100 mm, izolacja ochronna 1000 V AC	
Śrubokręt z końcówką płaską [00340855]	Końcówka 5,5 mm x 1,0 mm x 125 mm, izolacja ochronna 1000 V AC	
Szczypce wydłużone, wygięte [00341269]	Długość 200 mm	
Szczypce z nożami bocznymi [00342182]	Długość: 200 mm	



Przeznaczenie	Detale	Zdjęcia
Klucz płasko-oczkowy [00340811]	Rozmiar klucza 10 <sup>o</sup> mm, M6	
Combination wrench [00340814]	Rozmiar klucza 13 <sup>o</sup> mm, M8	
Klucz płasko-oczkowy [00340817]	Rozmiar klucza 17 mm, M10	
Klucz płasko-oczkowy [15000459]	Rozmiar klucza 16 <sup>o</sup> mm, M10	

## 4.1 Wymiana blatu roboczego

### Pomoce specjalne

-  Torx Bit TX20 z dziurą Długość 152 mm, długość użytkowa [00341272]  
124 mm, 1/4" mocowanie sześciokątne (6.35 mm), do wkrętów z trzpieniem zabezpieczającym

### Warunek:

-  Urządzenie odłączone od źródła zasilania.
-  Urządzenie jest odłączone od źródła wody.

### 4.1.1 Demontaż blatu roboczego

- ▶ 1. Wykręcić śruby (1).
- ▶ 2. Przesunąć blat roboczy w stronę tyłu urządzenia (2).
- ▶ 3. Podnieść blat roboczy do góry (3), aby go zdjąć.

### 4.1.2 Montaż blatu roboczego



Sprawdzić sposób montażu kabla. Kabel może być zakleszczony.

- ▶ Montaż w odwrotnej kolejności.

## 4.2 Wymiana dozownika detergentu

### Warunek:

- ✔ Urządzenie odłączone od źródła zasilania.
- ✔ Urządzenie jest odłączone od źródła wody.

### 4.2.1 Demontaż dozownika detergentu

1. Wysunąć dozownik detergentu.
2. 1. Nacisnąć wsuwaną część do dołu (1).  
2. Wyjąć dozownik detergentu (2).

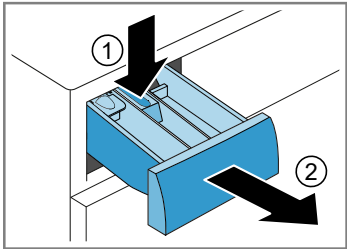

### 4.2.2 Montaż dozownika detergentu

- ▶ Montaż w odwrotnej kolejności.

## 4.3 Wymiana uchwyty dozownika detergentu

### Warunek:

- ✔ Urządzenie odłączone od źródła zasilania.
- ✔ Urządzenie jest odłączone od źródła wody.
- ✔ [Dozownik detergentu został wyjęty. → 315](#)

### 4.3.1 Demontaż uchwyty dozownika detergentu

1. Zwolnić zatrzaski.

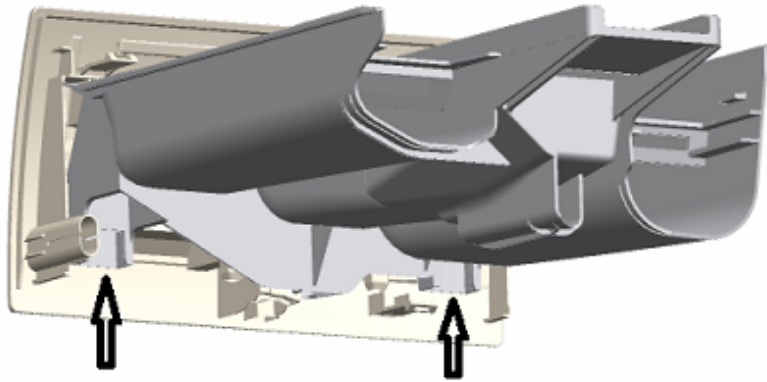

2. Wyjąć uchwyt dozownika detergentu.

### 4.3.2 Montaż uchwyty dozownika detergentu

- ▶ Montaż w odwrotnej kolejności.

## 4.4 Wymiana panelu przedniego

Jako producent mamy zgodnie z rozporządzeniem (UE) 2019/2023 obowiązek udostępnienia klientowi panelu przedniego jako części zamiennej wraz z instrukcją naprawy. Informujemy jednak, że przed ponownym rozpoczęciem użytkowania urządzenia po wymianie panelu przedniego konieczne jest przeprowadzenie testu bezpieczeństwa elektrotechnicznego przez wykwalifikowanego elektryka. Osoba ta musi posiadać kwalifikacje i uprawnienia wymagane zgodnie z ustawodawstwem, przepisami i normami kraju użytkowania.

	<b>⚠ NIEBEZPIECZEŃSTWO</b>
	<p><b>Ryzyko porażenia prądem elektrycznym wskutek kontaktu z elementami znajdującymi się pod napięciem!</b>                  Niebezpieczeństwo utraty życia wskutek porażenia prądem elektrycznym w przypadku nieprawidłowej naprawy</p> <ul style="list-style-type: none"> <li>▶ Części elektryczne powinny być naprawiane przez wykwalifikowanych elektryków.</li> <li>▶ Po naprawie należy przeprowadzić test bezpieczeństwa zgodny z przepisami normy VDE 0701 (Niemcy) lub odpowiednimi przepisami obowiązującymi w kraju użytkowania.</li> </ul>





	<b>⚠ OSTRZEŻENIE</b>
	<p><b>Możliwość wyslizgnięcia się przechylonego urządzenia!</b>                  Złamania kości / zmiżdżenia</p> <ul style="list-style-type: none"> <li>▶ Zabezpieczyć urządzenia przed wyslizgnięciem.</li> </ul>

	<b>⚠ WAŻNE</b>
	<p><b>Ostre krawędzie obudowy!</b>                  Rany cięte</p> <ul style="list-style-type: none"> <li>▶ Zawsze używaj rękawic ochronnych.</li> </ul>

	<b>⚠ WAŻNE</b>
	<p><b>Niebezpieczeństwo spadnięcia części po wykręceniu śrub!</b>                  Zranienie przez spadające części.</p> <ul style="list-style-type: none"> <li>▶ Zabezpieczyć część przed spadnięciem.</li> </ul>

	<b>UWAGA!</b>
	<p><b>Niebezpieczeństwo spadnięcia części po wykręceniu śrub!</b>                  Uszkodzenie innych części urządzenia albo pomieszczenia mieszkalnego, np. podłogi.</p> <ul style="list-style-type: none"> <li>▶ Zabezpieczyć część przed spadnięciem.</li> </ul>

**Warunek:**

-  Urządzenie odłączone od źródła zasilania.
-  Urządzenie jest odłączone od źródła wody.
-  [Błat roboczy został zdemontowany.→314](#)
-  [Dozownik detergentu został wyjęty.→315](#)

## 4.4.1 Demontaż panelu przedniego

1. Wykręcić śruby (1).
2. Zwolnić zatrzask (2, 3).

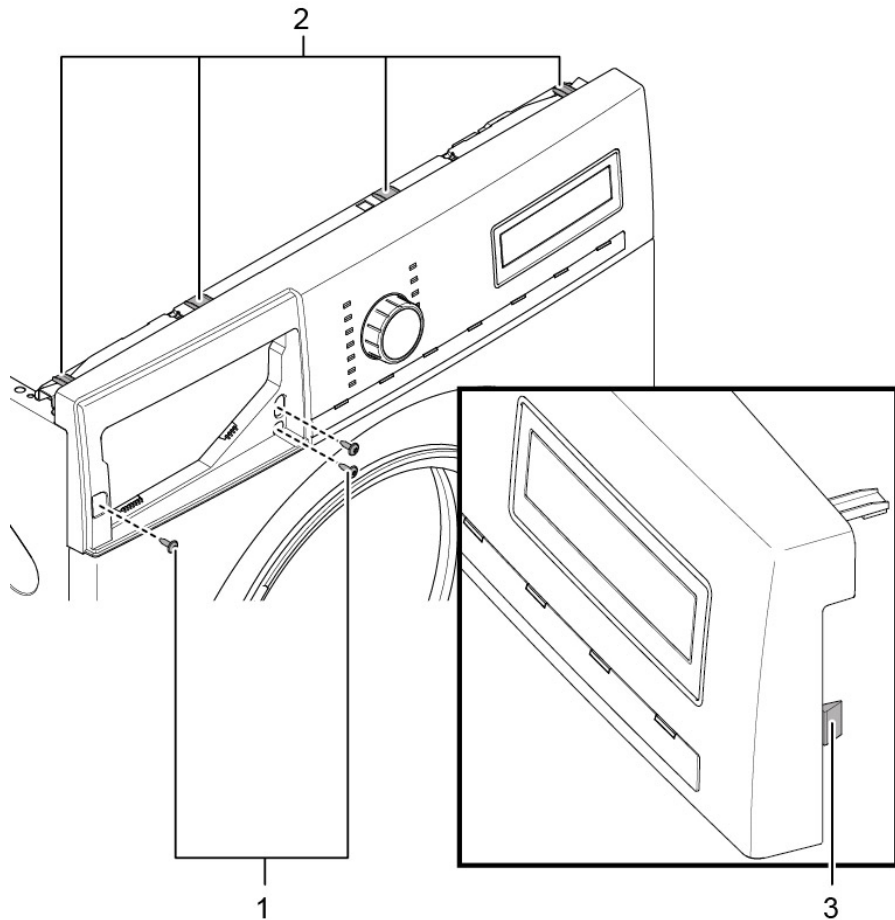

2. Odłączyć wtyk modułu sterującego.
3. Zdjąć panel przedni.

## 4.4.2 Montaż panelu przedniego



Sprawdzić sposób montażu kabla. Kabel może być zakleszczony.

- ▶ Montaż w odwrotnej kolejności.

## 4.5 Wymiana drzwi



### WAŻNE

#### Odsłonięty zawias!

Zmiażdżenie / uwięzienie palca

- ▶ Nie wkładać rąk pod zawiasy.
- ▶ Zawsze używaj rękawic ochronnych.



### WAŻNE

#### Niebezpieczeństwo spadnięcia części po wykręceniu śrub!

Zranienie przez spadające części.

- ▶ Zabezpieczyć część przed spadnięciem.



### UWAGA!

#### Niebezpieczeństwo spadnięcia części po wykręceniu śrub!

Uszkodzenie innych części urządzenia albo pomieszczenia mieszkalnego, np. podłogi.

- ▶ Zabezpieczyć część przed spadnięciem.

#### Warunek:

- ✔ Urządzenie odłączone od źródła zasilania.
- ✔ Urządzenie jest odłączone od źródła wody.
- ✔ Drzwiczki są otwarte.

### 4.5.1 Demontaż drzwi

1. Wykręcić śruby (1).

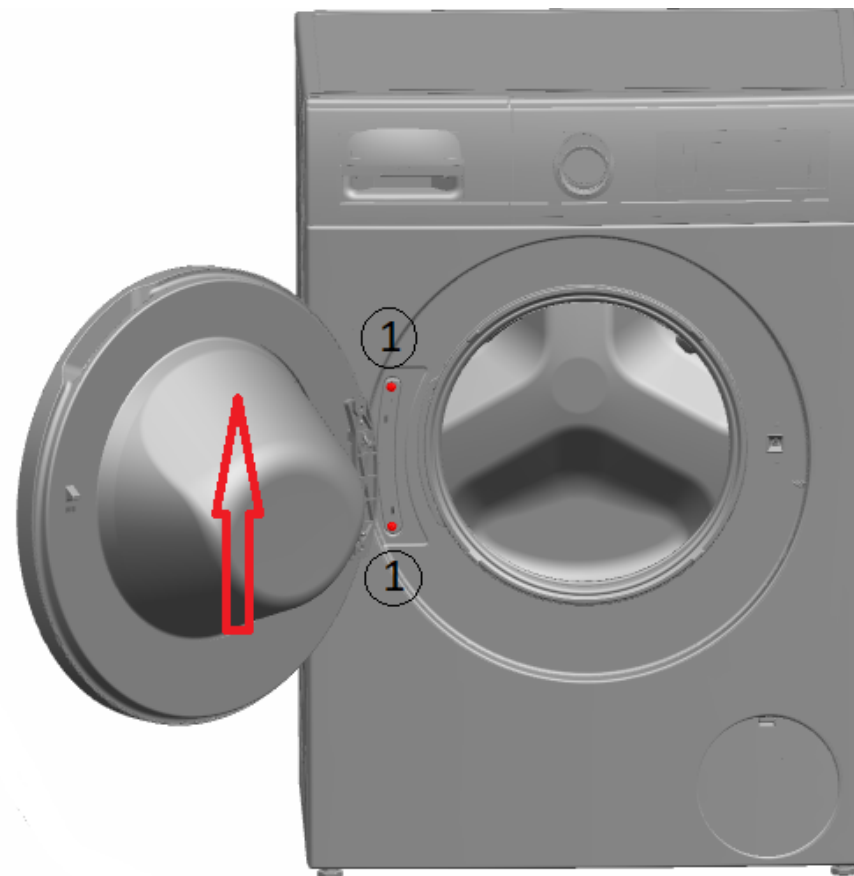



2. Wyjąć drzwiczki do góry.

### 4.5.2 Montaż drzwi

- ▶ Montaż w odwrotnej kolejności.

## 4.6 Wymiana komponentów drzwiczek

	<b>⚠ OSTRZEŻENIE</b>
	<b>Ciężkie i ruchome elementy!</b> Ryzyko zmiżdżenia części ciała podczas naprawy, obsługi lub diagnostyki przez ciężkie i ruchome elementy <ul style="list-style-type: none"><li>▶ Stosować obuwie ochronne.</li><li>▶ Zabezpieczyć ciężkie elementy przed upadkiem.</li><li>▶ Nie dotykać ruchomych elementów podczas pracy urządzenia.</li></ul>

	<b>⚠ WAŻNE</b>
	<b>Odślonięty zawias!</b> Zmiażdżenie / uwięzienie palca <ul style="list-style-type: none"><li>▶ Nie wkładać rąk pod zawiasy.</li><li>▶ Zawsze używaj rękawic ochronnych.</li></ul>

### Warunek:

- ✔ Urządzenie odłączone od źródła zasilania.
- ✔ Urządzenie jest odłączone od źródła wody.
- ✔ [Drzwi zostały zdemontowane. → 319](#)

### 4.6.1 Demontaż komponentów drzwiczek

- ▶ Zdemontować drzwiczki od zewnątrz do wewnątrz.

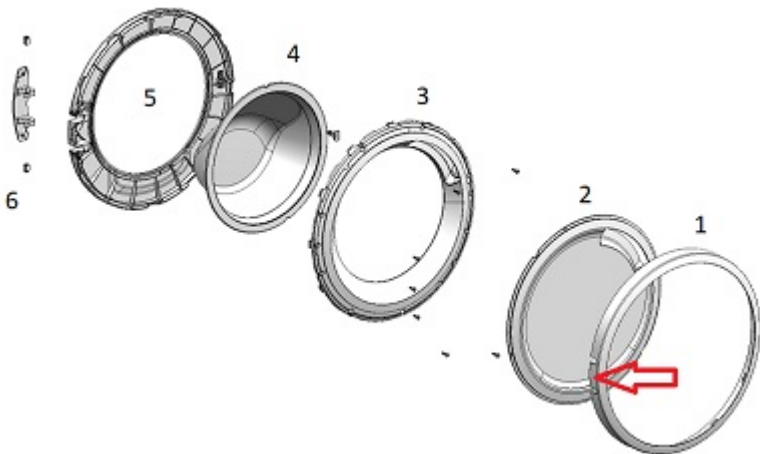

### 4.6.2 Montaż komponentów drzwiczek

- ▶ Montaż w odwrotnej kolejności.

## 4.7 Wymiana osłony pompy

### Warunek:

- ✔ Urządzenie odłączone od źródła zasilania.
- ✔ Urządzenie jest odłączone od źródła wody.

### 4.7.1 Demontaż osłony pompy

1. Otworzyć osłonę pompy.

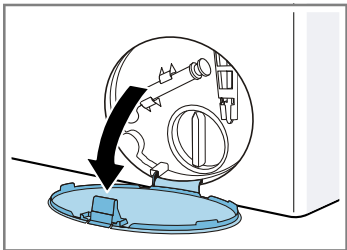

2. Zdjąć osłonę pompy.

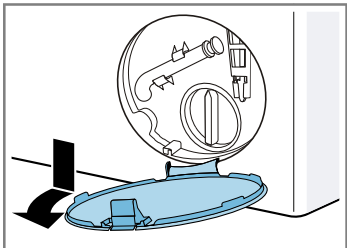



### 4.7.2 Montaż osłony pompy

- ▶ Montaż w odwrotnej kolejności.

## 4.8 Wymiana uszczelki drzwi

	<p><b>WAŻNE</b></p> <p><b>Ostre krawędzie obudowy!</b> Rany cięte</p> <ul style="list-style-type: none"> <li>▶ Zawsze używaj rękawic ochronnych.</li> </ul>
--	---

	<p><b>WAŻNE</b></p> <p><b>Niebezpieczeństwo spadnięcia części po wykręceniu śrub!</b> Zranienie przez spadające części.</p> <ul style="list-style-type: none"> <li>▶ Zabezpieczyć część przed spadnięciem.</li> </ul>
--	---

	<p><b>UWAGA!</b></p> <p><b>Niebezpieczeństwo spadnięcia części po wykręceniu śrub!</b> Uszkodzenie innych części urządzenia albo pomieszczenia mieszkalnego, np. podłogi.</p> <ul style="list-style-type: none"> <li>▶ Zabezpieczyć część przed spadnięciem.</li> </ul>
--	---

### Warunek:

- ✔ Urządzenie odłączone od źródła zasilania.
- ✔ Urządzenie jest odłączone od źródła wody.
- ✔ Urządzenie jest swobodnie dostępne.
- ✔ [Błat roboczy został zdemontowany.→314](#)
- ✔ [Dozownik detergentu został wyjęty.→315](#)
- ✔ [Panel przedni został zdemontowany.→318](#)
- ✔ [Drzwi zostały zdemontowane.→319](#)
- ✔ [Pokrywa pompy została zdjęta.→321](#)
- ✔ [Ściana przednia została zdemontowana.→327](#)
- ✔ [Oświetlenie bębna zostało zdemontowane \(opcjonalne\).→326](#)

### 4.8.1 Demontaż uszczelki drzwi

1. Rozłączyć wszystkie połączenia węży.



2. Wyjąć uszczelkę drzwiczek.

### 4.8.2 Montaż uszczelki drzwi

	<p><b>OSTRZEŻENIE</b></p> <p><b>Niebezpieczeństwo spadnięcia części wskutek nieprawidłowego montażu!</b> Zranienie lub uszkodzenie urządzenia.</p> <ul style="list-style-type: none"> <li>▶ Dokręcić pierścieni naprężający uszczelki otworu pralki momentem obrotowym 3,4 Nm.</li> </ul>
---	---

- ▶ Montaż w odwrotnej kolejności.

## 4.9 Wymiana blokady drzwi

Jako producent mamy zgodnie z rozporządzeniem (UE) 2019/2023 obowiązek udostępnienia klientowi zamka drzwiczek jako części zamiennej wraz z instrukcją naprawy. Informujemy jednak, że przed ponownym rozpoczęciem użytkowania urządzenia po wymianie drzwiczek konieczne jest przeprowadzenie testu bezpieczeństwa elektrotechnicznego przez wykwalifikowanego elektryka. Osoba ta musi posiadać kwalifikacje i uprawnienia wymagane zgodnie z ustawodawstwem, przepisami i normami kraju użytkowania.

	<b>⚠ NIEBEZPIECZEŃSTWO</b>
	<p><b>Ryzyko porażenia prądem elektrycznym wskutek kontaktu z elementami znajdującymi się pod napięciem!</b>          Niebezpieczeństwo utraty życia wskutek porażenia prądem elektrycznym w przypadku nieprawidłowej naprawy</p> <ul style="list-style-type: none"> <li>▶ Części elektryczne powinny być naprawiane przez wykwalifikowanych elektryków.</li> <li>▶ Po naprawie należy przeprowadzić test bezpieczeństwa zgodny z przepisami normy VDE 0701 (Niemcy) lub odpowiednimi przepisami obowiązującymi w kraju użytkowania.</li> </ul>

	<b>⚠ OSTRZEŻENIE</b>
	<p><b>Możliwość wyslizgnięcia się przechylonego urządzenia!</b>          Złamania kości / zmiżdżenia</p> <ul style="list-style-type: none"> <li>▶ Zabezpieczyć urządzenia przed wyslizgnięciem.</li> </ul>

	<b>⚠ WAŻNE</b>
	<p><b>Ostre krawędzie obudowy!</b>          Rany cięte</p> <ul style="list-style-type: none"> <li>▶ Zawsze używaj rękawic ochronnych.</li> </ul>

	<b>⚠ WAŻNE</b>
	<p><b>Niebezpieczeństwo spadnięcia części po wykręceniu śrub!</b>          Zranienie przez spadające części.</p> <ul style="list-style-type: none"> <li>▶ Zabezpieczyć część przed spadnięciem.</li> </ul>

	<b>UWAGA!</b>
	<p><b>Niebezpieczeństwo spadnięcia części po wykręceniu śrub!</b>          Uszkodzenie innych części urządzenia albo pomieszczenia mieszkalnego, np. podłogi.</p> <ul style="list-style-type: none"> <li>▶ Zabezpieczyć część przed spadnięciem.</li> </ul>

### Warunek:

- ✓ Urządzenie odłączone od źródła zasilania.
- ✓ Urządzenie jest odłączone od źródła wody.
- ✓ Urządzenie jest swobodnie dostępne.
- ✓ [Błat roboczy został zdemontowany.→314](#)
- ✓ [Dozownik detergentu został wyjęty.→315](#)
- ✓ [Panel przedni został zdemontowany.→318](#)
- ✓ [Drzwi zostały zdemontowane.→319](#)
- ✓ Pierścień naprężający został zdemontowany.
- ✓ [Została wyjęta uszczelka drzwiczek.→322](#)
- ✓ [Pokrywa pompy została zdjęta.→321](#)
- ✓ [Ściana przednia została zdemontowana.→327](#)

### 4.9.1 Demontaż blokady drzwi

1. Odłączyć wtyczkę zamka drzwiczek.
2. Zwolnić blokadę drzwi.



- Wyjąć blokadę drzwi.

## 4.9.2 Montaż blokady drzwi

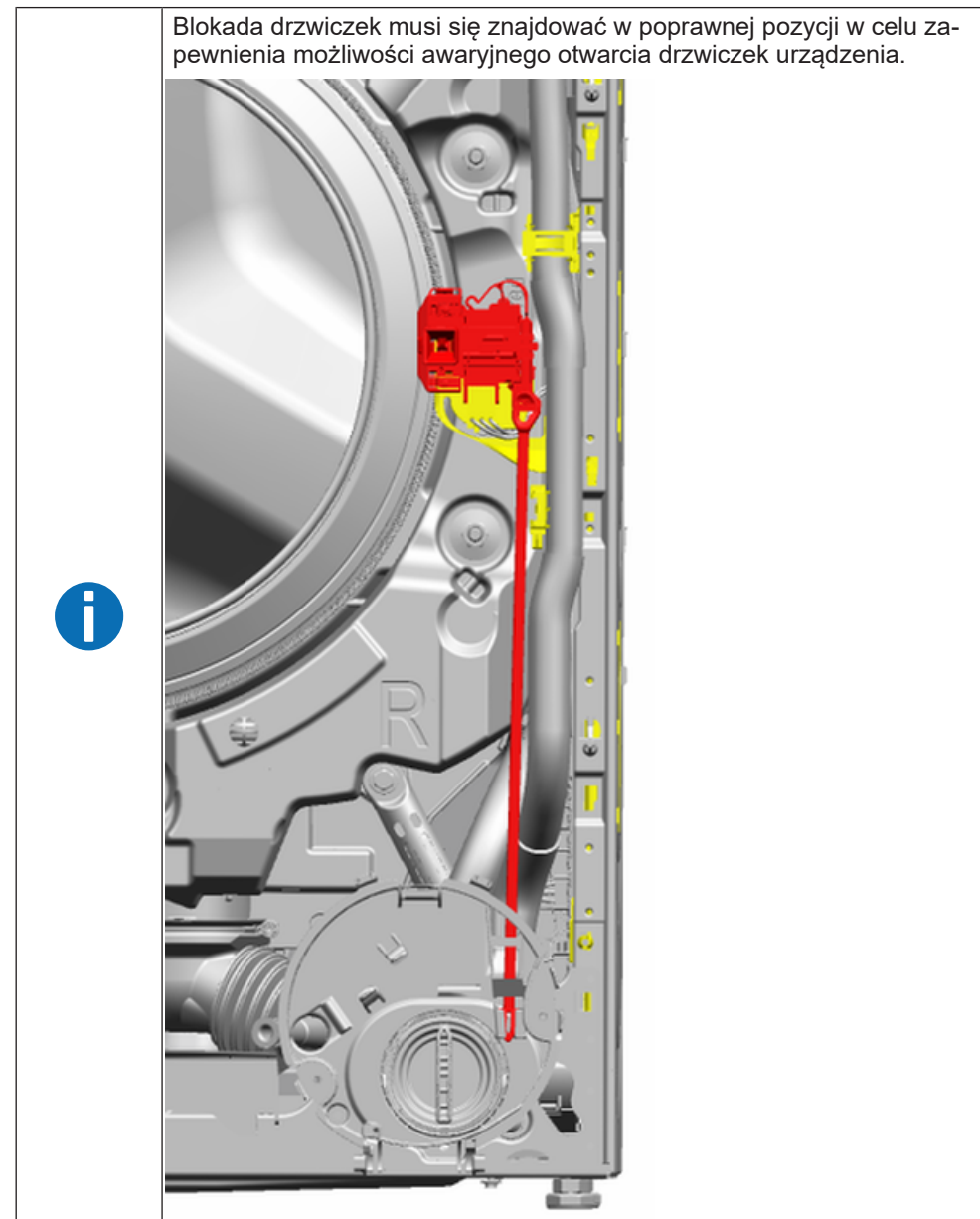

## Naprawy

- ▶ Montaż w odwrotnej kolejności.

## 4.10 Wymiana oświetlenia bębna



### OSTRZEŻENIE

**Możliwość wyślizgnięcia się przechylonego urządzenia!**  
Złamania kości / zmiążdżenia  
▶ Zabezpieczyć urządzenia przed wyślizgnięciem.



### WAŻNE

**Ostre krawędzie obudowy!**  
Rany cięte  
▶ Zawsze używaj rękawic ochronnych.



### WAŻNE

**Niebezpieczeństwo spadnięcia części po wykręceniu śrub!**  
Zranienie przez spadające części.  
▶ Zabezpieczyć część przed spadnięciem.



### UWAGA!

**Niebezpieczeństwo spadnięcia części po wykręceniu śrub!**  
Uszkodzenie innych części urządzenia albo pomieszczenia mieszkalnego, np. podłogi.  
▶ Zabezpieczyć część przed spadnięciem.

### Warunek:

- ✔ Urządzenie odłączone od źródła zasilania.
- ✔ Urządzenie jest odłączone od źródła wody.
- ✔ Urządzenie jest swobodnie dostępne.
- ✔ [Błat roboczy został zdemontowany. → 314](#)
- ✔ [Dozownik detergentu został wyjęty. → 315](#)
- ✔ [Panel przedni został zdemontowany. → 318](#)

## 4.10.1 Demontaż oświetlenia bębna

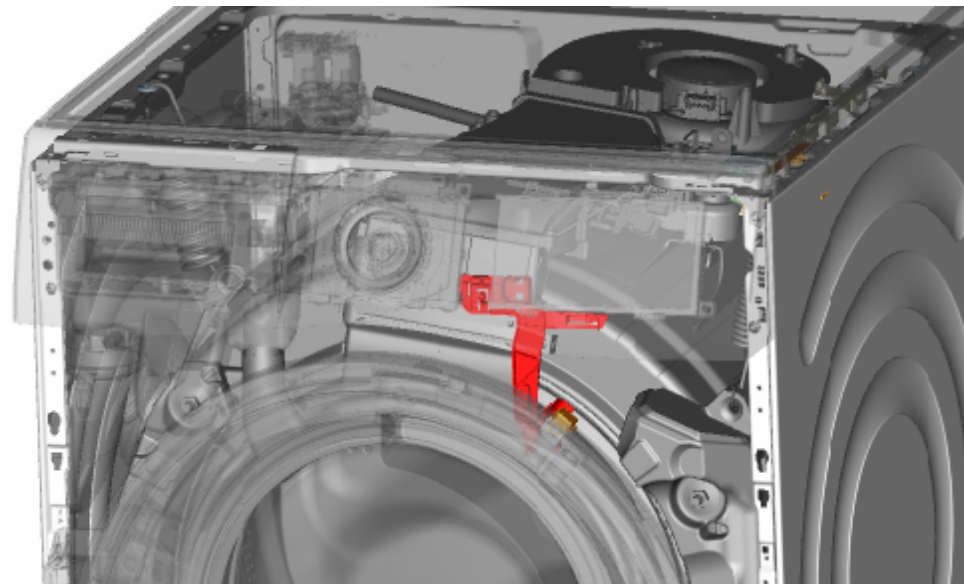

1. Wyciągnąć uchwyt oświetlenia bębna z urządzenia.
2. Rozłączyć złącza elektryczne.
3. Wyjąć oświetlenie bębna z uchwytu oświetlenia bębna.

## 4.10.2 Montaż oświetlenia bębna



Sprawdzić sposób montażu kabla. Kabel może być zakleszczony.

- ▶ Montaż w odwrotnej kolejności.

## 4.11 Wymiana ściany przedniej



### OSTRZEŻENIE

**Możliwość wyslizgnięcia się przechylonego urządzenia!**  
Złamania kości / zmiżdżenia  
▶ Zabezpieczyć urządzenia przed wyslizgnięciem.



### WAŻNE

**Ostre krawędzie obudowy!**  
Rany cięte  
▶ Zawsze używaj rękawic ochronnych.



### WAŻNE

**Niebezpieczeństwo spadnięcia części po wykręceniu śrub!**  
Zranienie przez spadające części.  
▶ Zabezpieczyć część przed spadnięciem.



### UWAGA!

**Niebezpieczeństwo spadnięcia części po wykręceniu śrub!**  
Uszkodzenie innych części urządzenia albo pomieszczenia mieszkalnego, np. podłogi.  
▶ Zabezpieczyć część przed spadnięciem.

#### Warunek:

- ✔ Urządzenie odłączone od źródła zasilania.
- ✔ Urządzenie jest odłączone od źródła wody.
- ✔ Urządzenie jest swobodnie dostępne.
- ✔ [Błat roboczy został zdemontowany. → 314](#)
- ✔ [Dozownik detergentu został wyjęty. → 315](#)
- ✔ [Panel przedni został zdemontowany. → 318](#)
- ✔ [Drzwi zostały zdemontowane. → 319](#)
- ✔ [Pokrywa pompy została zdjęta. → 321](#)
- ✔ Pierścień naprężający został zdemontowany.
- ✔ Uszczelka drzwiczek została poluzowana w przedniej części.
- ✔ [Oświetlenie bębna zostało zdemontowane \(opcjonalne\). → 326](#)

### 4.11.1 Demontaż ściany przedniej

1. Podnieść przednią część urządzenia.
2. Wykręcić dolne śruby (1).

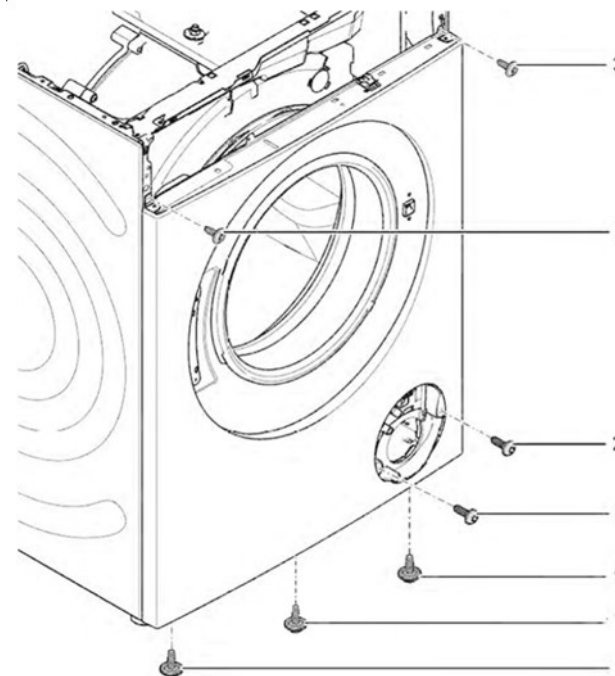

3. Opuścić urządzenie.

4. Wykręcić przednie śruby zaczynając od dołu i kończąc u góry (2, 3).

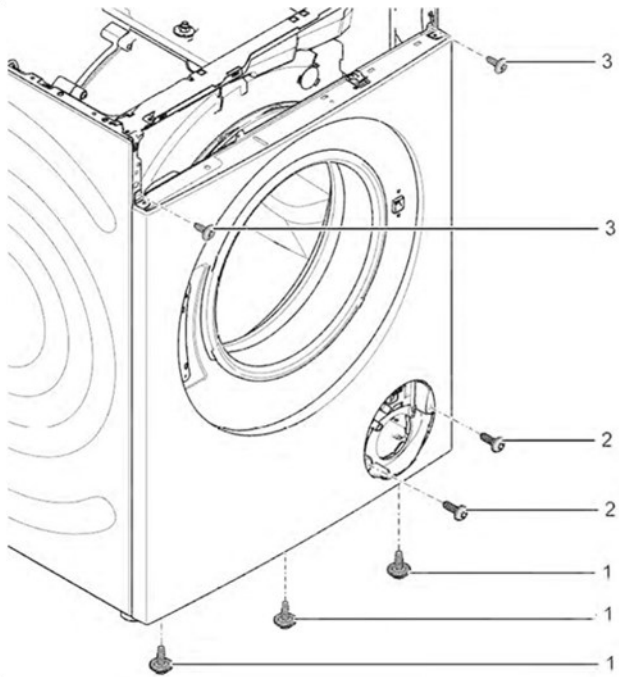

5. Zdjąć panel przedni.

### 4.11.2 Montaż ściany przedniej

- ▶ Montaż w odwrotnej kolejności.

# Dicas de resolução - Máquina de lavar roupa

## Sobre este documento..... 330

1.1	Informação importante.....	330
1.1.1	Finalidade.....	330
1.2	Explicação dos símbolos.....	330
1.2.1	Níveis de perigo.....	330
1.2.2	Símbolos de perigo.....	330
1.2.3	Estrutura dos avisos.....	331
1.2.4	Símbolos gerais.....	331

## Segurança..... 332

2.1	Instruções gerais de segurança.....	332
2.1.1	Todos os eletrodomésticos.....	332

## Ferramentas e auxiliares..... 333

## Reparação..... 334

4.1	Substituir o tampo.....	334
4.1.1	Remover o tampo.....	334
4.1.2	Instalar o tampo.....	334
4.2	Substituir a gaveta para detergente.....	335
4.2.1	Remover a gaveta para detergente.....	335
4.2.2	Instalar a gaveta para detergente.....	335
4.3	Substituir a pega da gaveta para detergente.....	336
4.3.1	Remover a pega da gaveta para detergente.....	336
4.3.2	Instalar a pega da gaveta para detergente.....	336
4.4	Substituir o painel dos comandos.....	337
4.4.1	Remover o painel dos comandos.....	337
4.4.2	Instalar o painel dos comandos.....	338
4.5	Substituir a porta.....	339
4.5.1	Remover a porta.....	339
4.5.2	Instalar a porta.....	339
4.6	Substituir os componentes da porta.....	340
4.6.1	Remover os componentes da porta.....	340
4.6.2	Instalar os componentes da porta.....	340
4.7	Substituir a tampa da bomba.....	341
4.7.1	Remover a tampa da bomba.....	341
4.7.2	Instalar a tampa da bomba.....	341

4.8	Substituir a vedação da porta.....	342
4.8.1	Remover a vedação da porta.....	342
4.8.2	Instalar a vedação da porta.....	342
4.9	Substituir o dispositivo de bloqueio da porta.....	343
4.9.1	Remover o dispositivo de bloqueio da porta.....	343
4.9.2	Instalar o dispositivo de bloqueio da porta.....	344
4.10	Substituir a luz do tambor.....	345
4.10.1	Remover a luz do tambor.....	345
4.10.2	Instalar a luz do tambor.....	345
4.11	Substituir o painel frontal.....	346
4.11.1	Remover o painel frontal.....	346
4.11.2	Instalar o painel frontal.....	347

# **i** Sobre este documento

## 1.1 Informação importante

### 1.1.1 Finalidade

Estas dicas de reparação auxiliam o consumidor na reparação de aparelhos por ele próprio de acordo com o regulamento de "Eco-design" aplicável (a partir de 03/2021).

Estas contêm informações sobre como substituir peças sobressalentes definidas, incluindo avisos e riscos.

Em caso de dúvidas, entre em contacto com o nosso serviço de apoio ao cliente. Apenas nos responsabilizaremos por danos se as dicas de reparação tiverem sido devidamente seguidas.

## 1.2 Explicação dos símbolos

### 1.2.1 Níveis de perigo

Os níveis de aviso são compostos por um símbolo e uma palavra sinal. A palavra-sinal indica a gravidade do perigo.







Nível de aviso	Significado
	A não observância da mensagem de aviso resulta em morte ou ferimentos graves.
	A não observância da mensagem de aviso pode resultar em morte ou ferimentos graves.
	A não observância da mensagem de aviso pode resultar em ferimentos ligeiros.
	A não observância da mensagem de aviso pode resultar em danos materiais.

Tabela 1: Níveis de perigo

### 1.2.2 Símbolos de perigo

Os símbolos de perigo são representações simbólicas que dão uma indicação do tipo de perigo.

Neste documento são utilizados os seguintes símbolos de perigo:

Símbolo de perigo	Significado
	Mensagem geral de aviso
	Perigo de tensão elétrica
	Risco de explosão
	Perigo de cortes

## **i** Sobre este documento





Símbolo de perigo	Significado
	Perigo de esmagamento
	Perigo de superfícies quentes
	Perigo de campo eletromagnético intenso
	Perigo de radiação não-ionizante

Tabela 2: Símbolos de perigo

### 1.2.3 Estrutura dos avisos

Os avisos neste documento possuem um aspeto normalizado e uma estrutura normalizada.

	<div style="background-color: red; color: white; padding: 2px; text-align: center;"><b>⚠ PERIGO</b></div> <p><b>Tipo e origem do perigo!</b> Possíveis consequência de ignorar o perigo / aviso.</p> <ul style="list-style-type: none"> <li>▶ Medidas e proibições para prevenir o perigo.</li> </ul>
--	---

O seguinte exemplo mostra um aviso que adverte contra choques elétricos devido a partes sob tensão. A medida para evitar o perigo é mencionada.

	<div style="background-color: red; color: white; padding: 2px; text-align: center;"><b>⚠ PERIGO</b></div> <p><b>Risco de choque elétrico devido a partes sob tensão!</b> Morte por eletrocussão</p> <ul style="list-style-type: none"> <li>▶ Desligue os aparelhos da alimentação elétrica pelo menos 60 segundos antes de iniciar as reparações.</li> </ul>
--	--

### 1.2.4 Símbolos gerais

Neste documento são utilizados os seguintes símbolos gerais:







Símbolo ger.	Significado
	Identificação de uma dica especial (texto e/ou ilustração)
	Identificação de uma dica simples (apenas texto)
	Identificação de uma ligação para um tutorial em vídeo
	Identificação das ferramentas necessárias
	Identificação das condições prévias necessárias
	Identificação de uma condição (se ..., então ...)
	Identificação de um resultado
Iniciar	Identificação de uma tecla ou botão
[00123456]	Identificação de um número de material
Estado	Identificação de um texto exibido / janela (no visor do aparelho)

Tabela 3: Símbolos gerais

## 2.1 Instruções gerais de segurança

### 2.1.1 Todos os eletrodomésticos

#### **Risco de choque elétrico devido a partes sob tensão!**

- Erros por reparações envolvendo componentes elétricos podem provocar choques elétricos!
- Desligue o aparelho da rede elétrica pelo menos 60 segundos antes de iniciar o trabalho.
- Após a reparação, solicite a realização de um teste de segurança de acordo com VDE 0701 ou os regulamentos específicos do país.

#### **Risco de ferimentos causados por arestas vivas!**

- Use luvas de proteção.

#### **Risco de esmagamento durante trabalhos de reparação, manutenção, resolução de problemas e serviço devido a componentes pesados e móveis**

- Use calçado de proteção.
- Proteja os componentes pesados contra quedas.
- Não introduzir partes do corpo em componentes móveis.







#### **Risco para a segurança/funcionamento do aparelho!**

- Utilize apenas peças sobressalentes originais.

#### **Risco de danos em componentes electrostáticamente sensíveis (ESDs)!**

- Não toque nos módulos, incluindo ligações e percursos condutores.

## Ferramentas e auxiliares

Designação	Detalhes	Imagens
Ferramenta auxiliar [15000155]	Ferramenta para soltar as partes em plástico	
Chave parafusos Torx T20 com orifício [00340764]	100 mm, para parafusos com pino de segurança	
Chave dinamométrica [15000441]	Chave dinamométrica 20 - 100 Nm	
Chave de fenda [00340854]	Lâmina 3,5 mm x 0,6 mm x 100 mm, isolamento protetor 1000 V AC	
Chave de fenda [00340855]	Lâmina 5,5 mm x 1,0 mm x 125 mm, isolamento protetor 1000 V AC	
Alicate de pontas, padrão angular [00341269]	Comprimento 200 mm	
Alicate de corte [00342182]	Comprimento: 200 mm	



Designação	Detalhes	Imagens
Chave combinada [00340811]	Tamanho da chave 10ºmm, M6	
Combination wrench [00340814]	Tamanho da chave 13ºmm, M8	
Chave combinada [00340817]	Tamanho da chave 17 mm, M10	
Chave combinada [15000459]	Tamanho da chave 16ºmm, M10	

## 4.1 Substituir o tampo

### Ferramentas necessárias:

-  Ponta Torx TX20 com orifício Comprimento 152 mm, comprimento útil 124 mm, chave sextavada de 1/4" (6,35 mm), para parafusos com pino de segurança [00341272]

### Pré-requisito:

-  O aparelho está desligado da energia.
-  O aparelho está desligado do abastecimento de água.

### 4.1.1 Remover o tampo

- ▶ 1. Remova os parafusos (1).
- ▶ 2. Empurre o tampo para a parte de trás do aparelho (2).
- ▶ 3. Mova o tampo para cima (3) para removê-lo.

### 4.1.2 Instalar o tampo



Observar a instalação do cabo. O cabo pode estar preso.

- ▶ Instale pela ordem inversa.

## **4.2 Substituir a gaveta para detergente**

### **Pré-requisito:**

- ✔ O aparelho está desligado da energia.
- ✔ O aparelho está desligado do abastecimento de água.

### **4.2.1 Remover a gaveta para detergente**

1. Puxe a gaveta para detergente para fora.
2. 1. Pressione para baixo ao inserir (1).  
2. Remova a gaveta para detergente (2).

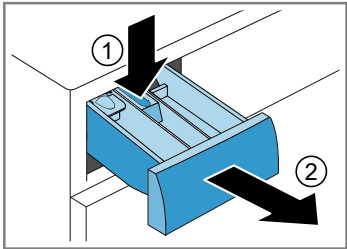

### **4.2.2 Instalar a gaveta para detergente**

- ▶ Instale pela ordem inversa.

## 4.3 Substituir a pega da gaveta para detergente

### Pré-requisito:

- ✓ O aparelho está desligado da energia.
- ✓ O aparelho está desligado do abastecimento de água.
- ✓ [A gaveta para detergente foi removida.→335](#)

### 4.3.1 Remover a pega da gaveta para detergente

1. Solte os elementos de encaixe.

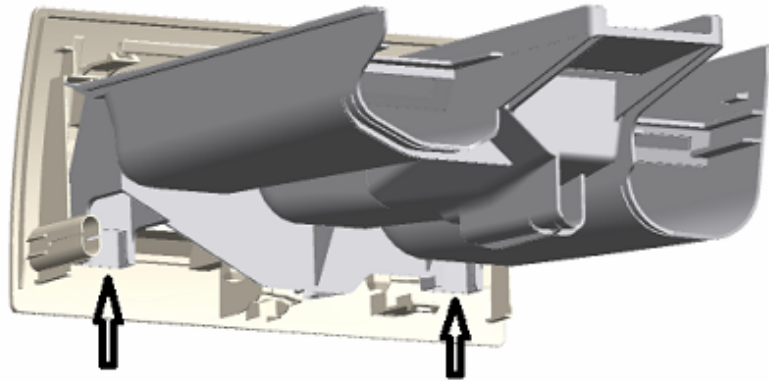

2. Remova a pega da gaveta para detergente.

### 4.3.2 Instalar a pega da gaveta para detergente

- ▶ Instale pela ordem inversa.

## 4.4 Substituir o painel dos comandos

Na qualidade de fabricante, somos obrigados a fornecer aos consumidores um painel da fachada sobressalente incluindo as instruções de reparação de acordo com o Regulamento (UE) 2019/2023. Contudo, gostaríamos de salientar que após a substituição de um painel da fachada, é necessário um teste de segurança eletrotécnica realizado por um profissional qualificado antes de colocar o dispositivo em funcionamento. Tem de ser possível verificar a qualificação da pessoa em questão de acordo com as leis, regulamentos e normas específicas do país.

	<b>⚠️ PERIGO</b>
	<b>Risco de choque elétrico devido a partes sob tensão!</b> Risco de vida devido a choque elétrico em caso de reparação inadequada <ul style="list-style-type: none"><li>▶ As partes elétricas devem ser reparadas por um electricista qualificado.</li><li>▶ Após a reparação, solicite a realização de um teste de segurança de acordo com VDE 0701 ou os regulamentos específicos do país.</li></ul>

	<b>⚠️ AVISO</b>
	<b>Deslizamento de aparelhos inclinados!</b> Fraturas ósseas / ferimentos de esmagamento <ul style="list-style-type: none"><li>▶ Proteja os aparelhos contra o deslizamento.</li></ul>

	<b>⚠️ CUIDADO</b>
	<b>Arestas vivas no alojamento!</b> Lesões por corte <ul style="list-style-type: none"><li>▶ Use luvas de proteção.</li></ul>

	<b>⚠️ CUIDADO</b>
	<b>Risco de queda de peças devido a parafusos desapertados!</b> Lesões devido à queda de peças. <ul style="list-style-type: none"><li>▶ Proteja o componente contra as quedas.</li></ul>

	<b>ATENÇÃO!</b>
	<b>Risco de queda de peças devido a parafusos desapertados!</b> Danos em outros componentes do aparelho ou na casa do cliente, p. ex., no pavimento. <ul style="list-style-type: none"><li>▶ Proteja o componente contra as quedas.</li></ul>

### Pré-requisito:

- ✓ O aparelho está desligado da energia.
- ✓ O aparelho está desligado do abastecimento de água.
- ✓ [O tampo foi removido. → 334](#)
- ✓ [A gaveta para detergente foi removida. → 335](#)

### 4.4.1 Remover o painel dos comandos

1. Remova os parafusos (1).
2. Solte os elementos de encaixe (2, 3).

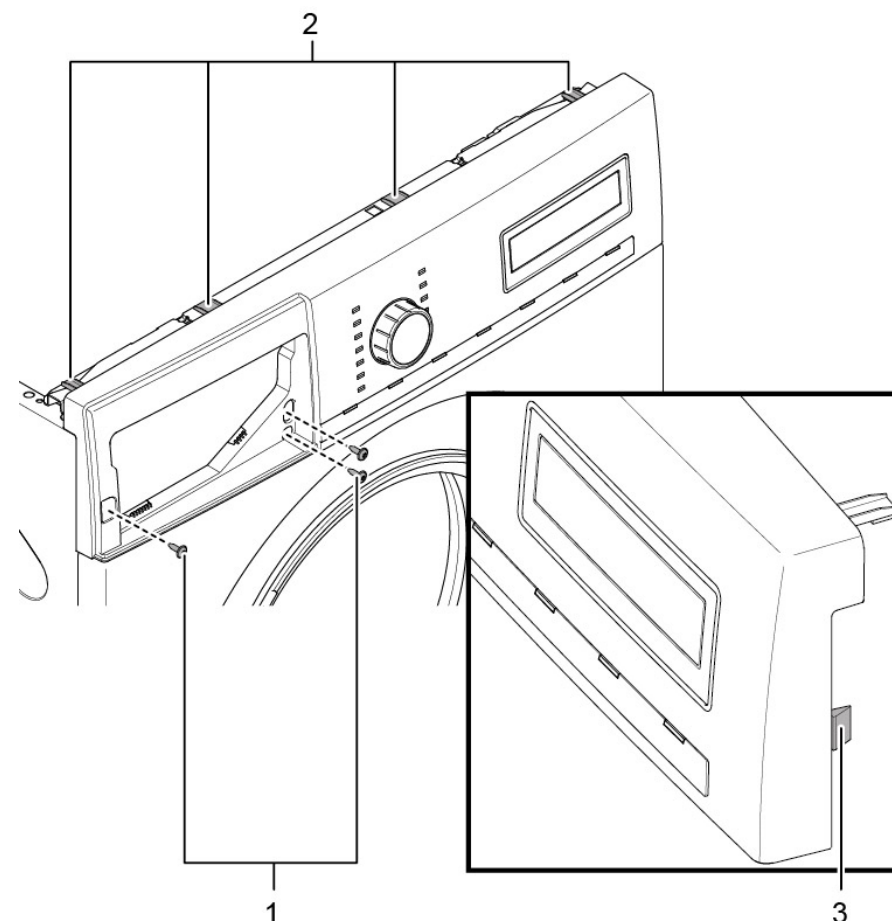

## Reparação

2. Solte o contacto de ligação da unidade de controlo.
3. Remova o painel dos comandos.

### 4.4.2 Instalar o painel dos comandos



Observar a instalação do cabo. O cabo pode estar preso.

- ▶ Instale pela ordem inversa.

## 4.5 Substituir a porta



### ⚠️ CUIDADO

#### Zona das dobradiças aberta!

Esmagamento / entalamento dos dedos

- ▶ Não coloque as mãos na zona das dobradiças.
- ▶ Use luvas de proteção.



### ⚠️ CUIDADO

#### Risco de queda de peças devido a parafusos desapertados!

Lesões devido à queda de peças.

- ▶ Proteja o componente contra as quedas.



### ⚠️ ATENÇÃO!

#### Risco de queda de peças devido a parafusos desapertados!

Danos em outros componentes do aparelho ou na casa do cliente, p. ex., no pavimento.

- ▶ Proteja o componente contra as quedas.

#### Pré-requisito:

- ✔ O aparelho está desligado da energia.
- ✔ O aparelho está desligado do abastecimento de água.
- ✔ A porta está aberta.

### 4.5.1 Remover a porta

1. Remova os parafusos (1).

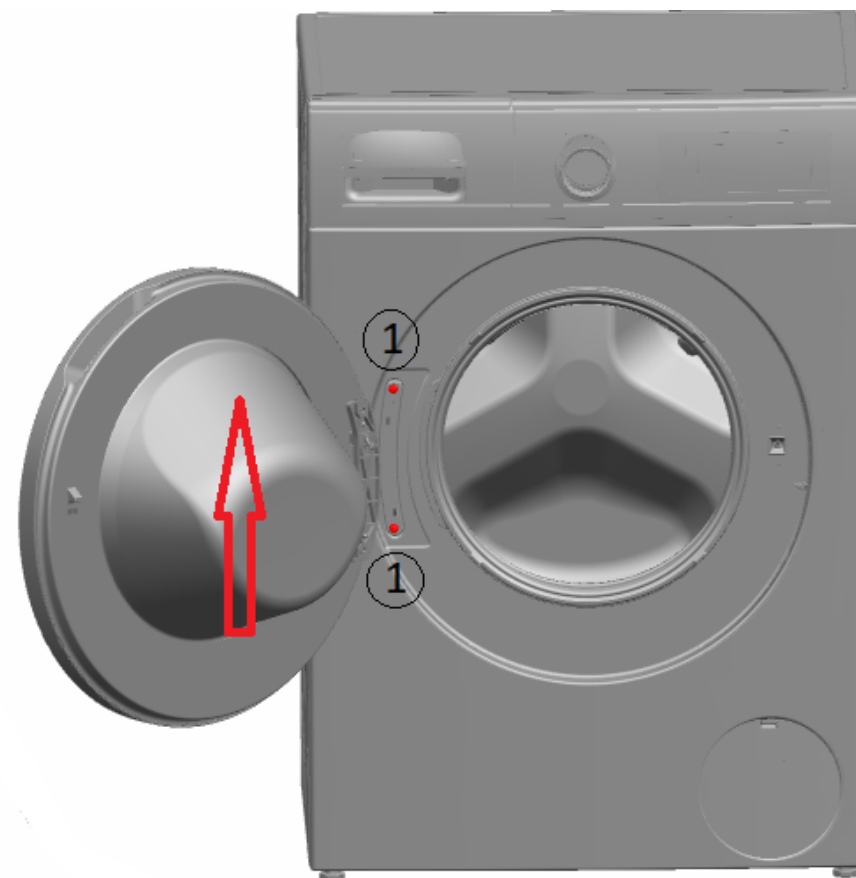



2. Remova a porta para cima.

### 4.5.2 Instalar a porta

- ▶ Instale pela ordem inversa.

## 4.6 Substituir os componentes da porta

	<b>AVISO</b>
	<b>Componentes pesados e móveis!</b> Risco de esmagamento durante trabalhos de reparação, manutenção, resolução de problemas e serviço. <ul style="list-style-type: none"><li>▶ Use calçado de proteção.</li><li>▶ Proteja os componentes pesados contra quedas.</li><li>▶ Não introduza partes do corpo em componentes móveis.</li></ul>

	<b>CUIDADO</b>
	<b>Zona das dobradiças aberta!</b> Esmagamento / entalamento dos dedos. <ul style="list-style-type: none"><li>▶ Não coloque as mãos na zona das dobradiças.</li><li>▶ Use luvas de proteção.</li></ul>

### Pré-requisito:

- ✔ O aparelho está desligado da energia.
- ✔ O aparelho está desligado do abastecimento de água.
- ✔ [A porta foi removida. → 339](#)

### 4.6.1 Remover os componentes da porta

- ▶ Desmonte a porta do exterior para o interior.

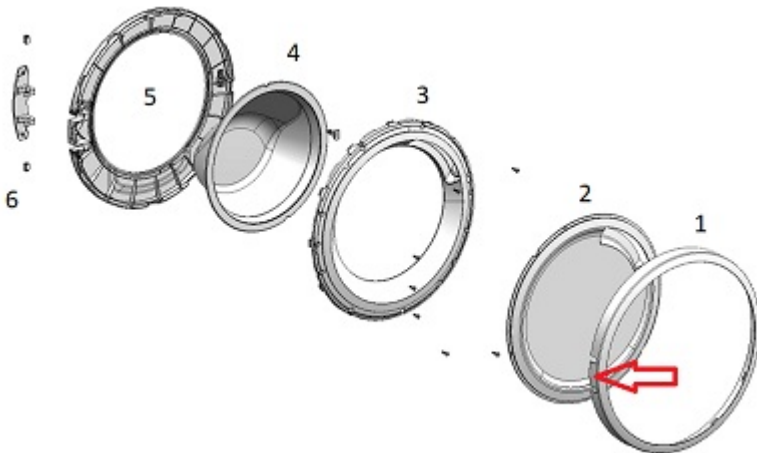

### 4.6.2 Instalar os componentes da porta

- ▶ Instale pela ordem inversa.

## 4.7 Substituir a tampa da bomba

### Pré-requisito:

- ✓ O aparelho está desligado da energia.
- ✓ O aparelho está desligado do abastecimento de água.

### 4.7.1 Remover a tampa da bomba

1. Abra a tampa da bomba.

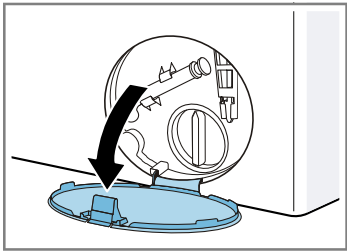

2. Remova a tampa da bomba.

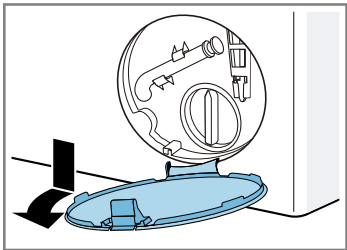

### 4.7.2 Instalar a tampa da bomba

- ▶ Instale pela ordem inversa.

## 4.8 Substituir a vedação da porta



### CUIDADO

**Arestas vivas no alojamento!**  
Lesões por corte  
▶ Use luvas de proteção.



### CUIDADO

**Risco de queda de peças devido a parafusos desapertados!**  
Lesões devido à queda de peças.  
▶ Proteja o componente contra as quedas.



### ATENÇÃO!

**Risco de queda de peças devido a parafusos desapertados!**  
Danos em outros componentes do aparelho ou na casa do cliente, p. ex., no pavimento.  
▶ Proteja o componente contra as quedas.

#### Pré-requisito:

- ✓ O aparelho está desligado da energia.
- ✓ O aparelho está desligado do abastecimento de água.
- ✓ O aparelho está livremente acessível.
- ✓ [O tampo foi removido.→334](#)
- ✓ [A gaveta para detergente foi removida.→335](#)
- ✓ [O painel da fachada foi removido.→337](#)
- ✓ [A porta foi removida.→339](#)
- ✓ [A tampa da bomba foi removida.→341](#)
- ✓ [O painel frontal foi removido.→346](#)
- ✓ [A Drum Light foi removida \(opcional\).→345](#)

### 4.8.1 Remover a vedação da porta

1. Solte todas as ligações de manguerias.

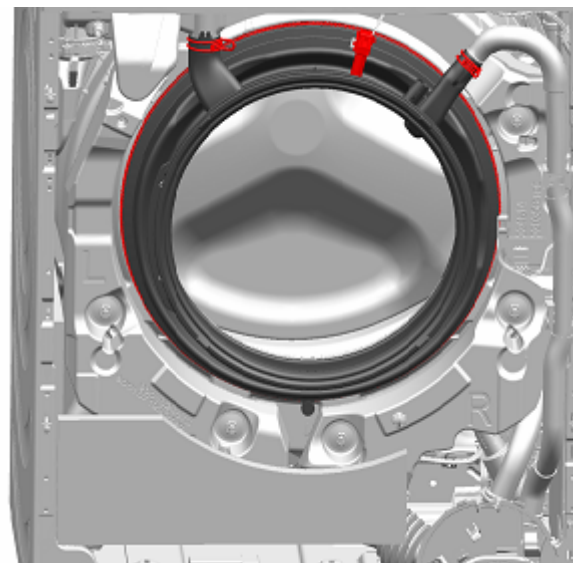

2. Remova a vedação da porta.

### 4.8.2 Instalar a vedação da porta



### AVISO

**Risco de queda de peças devido a instalação incorreta!**  
Ferimentos ou danos no aparelho.

- ▶ Aperte o anel de tensão da borracha do óculo com 3,4 Nm.
- ▶ Instale pela ordem inversa.

## 4.9 Substituir o dispositivo de bloqueio da porta

Na qualidade de fabricante, somos obrigados a fornecer aos consumidores um dispositivo de bloqueio da porta sobressalente incluindo as instruções de reparação de acordo com o Regulamento (UE) 2019/2023. Contudo, gostaríamos de salientar que após a substituição de um dispositivo de bloqueio da porta, é necessário um teste de segurança eletrotécnica realizado por um profissional qualificado antes de colocar o dispositivo em funcionamento. Tem de ser possível verificar a qualificação da pessoa em questão de acordo com as leis, regulamentos e normas específicas do país.

	<b>PERIGO</b>
	<b>Risco de choque elétrico devido a partes sob tensão!</b> Risco de vida devido a choque elétrico em caso de reparação inadequada <ul style="list-style-type: none"><li>▶ As partes elétricas devem ser reparadas por um electricista qualificado.</li><li>▶ Após a reparação, solicite a realização de um teste de segurança de acordo com VDE 0701 ou os regulamentos específicos do país.</li></ul>

	<b>AVISO</b>
	<b>Deslizamento de aparelhos inclinados!</b> Fraturas ósseas / ferimentos de esmagamento <ul style="list-style-type: none"><li>▶ Proteja os aparelhos contra o deslizamento.</li></ul>

	<b>CUIDADO</b>
	<b>Arestas vivas no alojamento!</b> Lesões por corte <ul style="list-style-type: none"><li>▶ Use luvas de proteção.</li></ul>

	<b>CUIDADO</b>
	<b>Risco de queda de peças devido a parafusos desapertados!</b> Lesões devido à queda de peças. <ul style="list-style-type: none"><li>▶ Proteja o componente contra as quedas.</li></ul>

	<b>ATENÇÃO!</b>
	<b>Risco de queda de peças devido a parafusos desapertados!</b> Danos em outros componentes do aparelho ou na casa do cliente, p. ex., no pavimento. <ul style="list-style-type: none"><li>▶ Proteja o componente contra as quedas.</li></ul>

### Pré-requisito:

- ✓ O aparelho está desligado da energia.
- ✓ O aparelho está desligado do abastecimento de água.
- ✓ O aparelho está livremente acessível.
- ✓ [O tampo foi removido.→334](#)
- ✓ [A gaveta para detergente foi removida.→335](#)
- ✓ [O painel da fachada foi removido.→337](#)
- ✓ [A porta foi removida.→339](#)
- ✓ O anel de tensão foi removido.
- ✓ [A vedação da porta foi removida.→342](#)
- ✓ [A tampa da bomba foi removida.→341](#)
- ✓ [O painel frontal foi removido.→346](#)

### 4.9.1 Remover o dispositivo de bloqueio da porta

1. Desligue a ficha do dispositivo de bloqueio da porta.
2. Solte o dispositivo de bloqueio da porta.



3. Remova o dispositivo de bloqueio da porta.



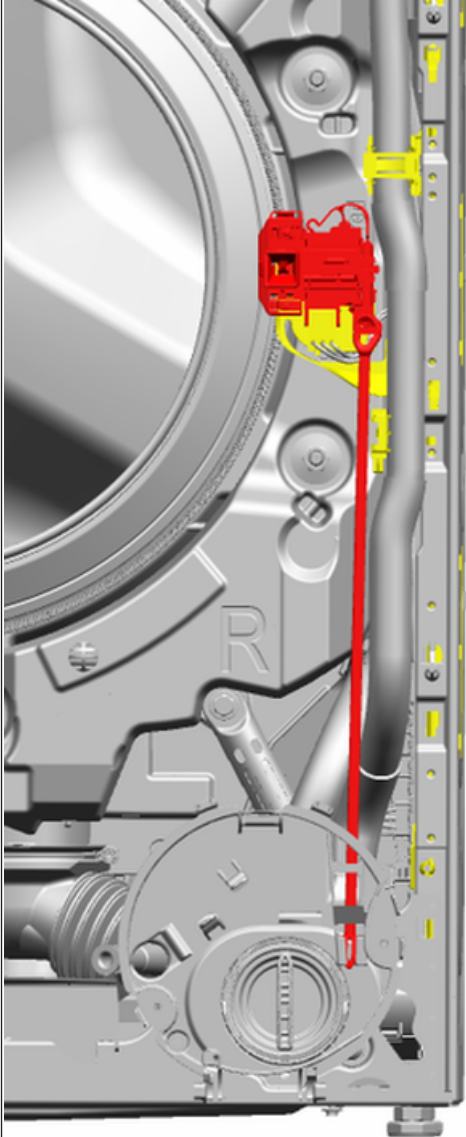

### 4.9.2 Instalar o dispositivo de bloqueio da porta

O dispositivo de bloqueio da porta deve estar na posição correta para garantir a função de abertura de emergência da porta do aparelho.



- ▶ Instale pela ordem inversa.

## 4.10 Substituir a luz do tambor

	<b>⚠️ AVISO</b> <b>Deslizamento de aparelhos inclinados!</b> Fraturas ósseas / ferimentos de esmagamento ▶ Proteja os aparelhos contra o deslizamento.
	<b>⚠️ CUIDADO</b> <b>Arestas vivas no alojamento!</b> Lesões por corte ▶ Use luvas de proteção.
	<b>⚠️ CUIDADO</b> <b>Risco de queda de peças devido a parafusos desapertados!</b> Lesões devido à queda de peças. ▶ Proteja o componente contra as quedas.
	<b>⚠️ ATENÇÃO!</b> <b>Risco de queda de peças devido a parafusos desapertados!</b> Danos em outros componentes do aparelho ou na casa do cliente, p. ex., no pavimento. ▶ Proteja o componente contra as quedas.

### Pré-requisito:

- ✔ O aparelho está desligado da energia.
- ✔ O aparelho está desligado do abastecimento de água.
- ✔ O aparelho está livremente acessível.
- ✔ [O tampo foi removido. → 334](#)
- ✔ [A gaveta para detergente foi removida. → 335](#)
- ✔ [O painel da fachada foi removido. → 337](#)

### 4.10.1 Remover a luz do tambor

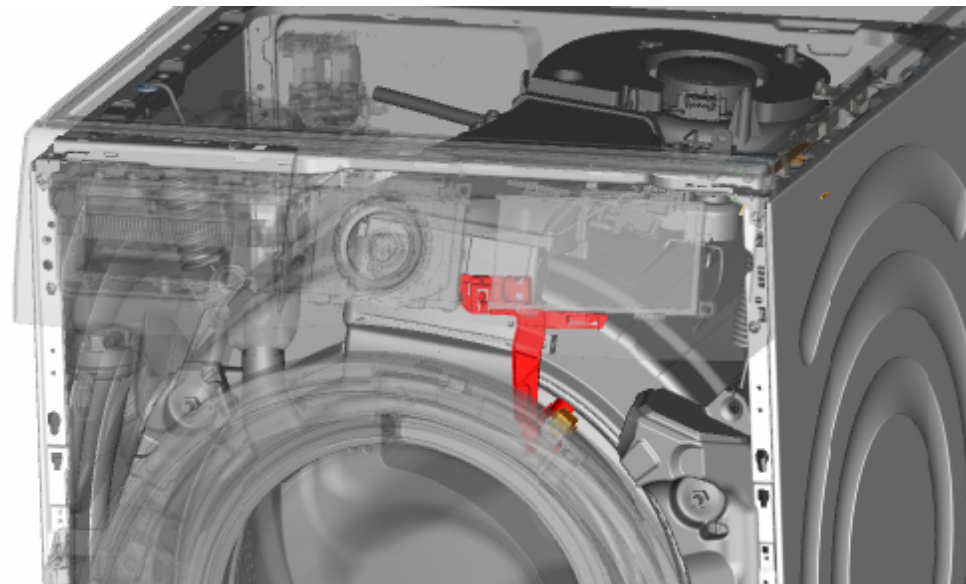

1. Puxe o suporte da luz do tambor para fora do aparelho.
2. Desligue as ligações elétricas.
3. Remova a luz do tambor do suporte da luz do tambor.

### 4.10.2 Instalar a luz do tambor

	Observar a instalação do cabo. O cabo pode estar preso.
---	---

- ▶ Instale pela ordem inversa.

## 4.11 Substituir o painel frontal



### ⚠️ AVISO

#### Deslizamento de aparelhos inclinados!

Fraturas ósseas / ferimentos de esmagamento  
▶ Proteja os aparelhos contra o deslizamento.



### ⚠️ CUIDADO

#### Arestas vivas no alojamento!

Lesões por corte  
▶ Use luvas de proteção.



### ⚠️ CUIDADO

#### Risco de queda de peças devido a parafusos desapertados!

Lesões devido à queda de peças.  
▶ Proteja o componente contra as quedas.



### ⚠️ ATENÇÃO!

#### Risco de queda de peças devido a parafusos desapertados!

Danos em outros componentes do aparelho ou na casa do cliente, p. ex., no pavimento.  
▶ Proteja o componente contra as quedas.

#### Pré-requisito:

- ✔ O aparelho está desligado da energia.
- ✔ O aparelho está desligado do abastecimento de água.
- ✔ O aparelho está livremente acessível.
- ✔ [O tampo foi removido. → 334](#)
- ✔ [A gaveta para detergente foi removida. → 335](#)
- ✔ [O painel da fachada foi removido. → 337](#)
- ✔ [A porta foi removida. → 339](#)
- ✔ [A tampa da bomba foi removida. → 341](#)
- ✔ O anel de tensão foi removido.
- ✔ A vedação da porta foi libertada na parte da frente.
- ✔ [A Drum Light foi removida \(opcional\). → 345](#)

### 4.11.1 Remover o painel frontal

1. Levante o aparelho na parte da frente.
2. Remova os parafusos na parte inferior (1).

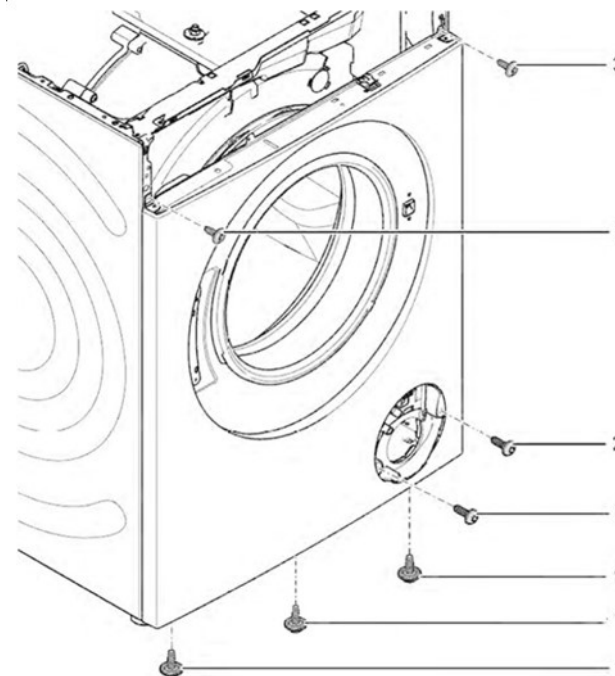

3. Baixe o aparelho.

## Reparação

4. Remova os parafusos na parte da frente começando de baixo para cima (2, 3).

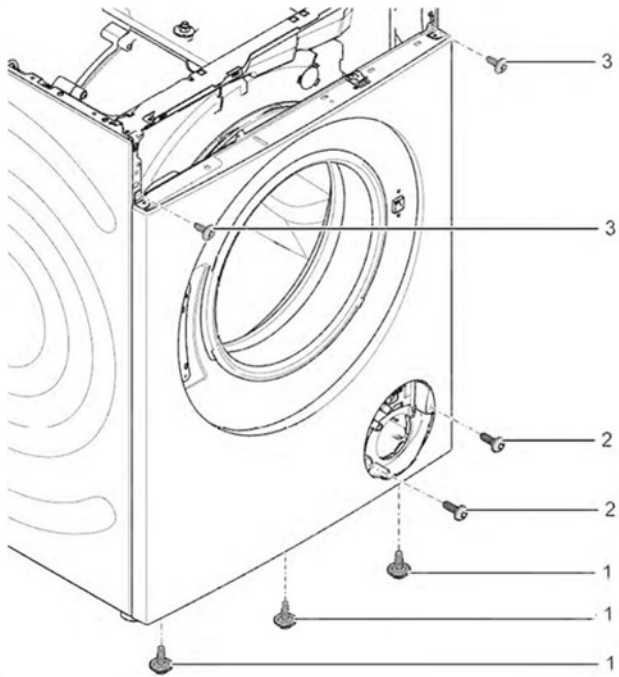

5. Remova o painel frontal.

### 4.11.2 Instalar o painel frontal

- ▶ Instale pela ordem inversa.

# Indicii pentru reparații - Mașină de spălat rufe

## Referitor la acest document..... 349

1.1	Informații importante .....	349
1.1.1	Aplicabilitatea .....	349
1.2	Explicația simbolurilor .....	349
1.2.1	Nivelurile de pericol .....	349
1.2.2	Simbolurile de pericol .....	349
1.2.3	Structura avertismentelor .....	350
1.2.4	Simbolurile generale .....	350

## Siguranța..... 351

2.1	Instrucțiuni generale de siguranță .....	351
2.1.1	Toate aparatele electrocasnice .....	351

## Instrumente și materiale utile..... 352

## Repararea..... 353

4.1	Înlocuirea părții superioare .....	353
4.1.1	Demontarea părții superioare .....	353
4.1.2	Montarea părții superioare .....	353
4.2	Înlocuirea sertarului pentru detergent..... 354	
4.2.1	Demontarea sertarului pentru detergent .....	354
4.2.2	Montarea sertarului pentru detergent..... 354	
4.3	Înlocuirea mânerului sertarului pentru detergent .....	355
4.3.1	Demontarea mânerului sertarului pentru detergent..... 355	
4.3.2	Montarea mânerului sertarului pentru detergent .....	355
4.4	Înlocuirea panoului de mascare .....	356
4.4.1	Demontarea panoului de mascare..... 357	
4.4.2	Montarea panoului de mascare .....	357
4.5	Înlocuirea ușii .....	358
4.5.1	Demontarea ușii..... 358	
4.5.2	Montarea ușii..... 358	
4.6	Înlocuirea componentelor ușii .....	359
4.6.1	Demontarea componentelor ușii..... 359	
4.6.2	Montarea componentelor ușii..... 359	
4.7	Înlocuirea capacului pompei .....	360
4.7.1	Demontarea capacului pompei..... 360	
4.7.2	Montarea capacului pompei .....	360

4.8	Înlocuirea garniturii ușii..... 361	
4.8.1	Demontarea garniturii ușii .....	361
4.8.2	Montarea garniturii ușii..... 361	
4.9	Înlocuirea dispozitivului de blocare a ușii .....	362
4.9.1	Demontarea dispozitivului de blocare a ușii..... 362	
4.9.2	Montarea dispozitivului de blocare a ușii .....	363
4.10	Înlocuirea iluminării cuvei..... 365	
4.10.1	Demontarea iluminării cuvei .....	365
4.10.2	Montarea iluminării cuvei .....	365
4.11	Înlocuirea panoului frontal..... 366	
4.11.1	Demontarea panoului frontal .....	366
4.11.2	Montarea panoului frontal..... 367	

# **i** Referitor la acest document

## 1.1 Informații importante

### 1.1.1 Aplicabilitatea

Aceste instrucțiuni de reparare îl ajută pe client să își repare singur aparatele, în conformitate cu normele de proiectare ecologică aplicabile (începând cu 03/2021).



Acestea conțin informații privind modul de înlocuire a pieselor de schimb specifice, inclusiv avertismente și pericole.

Dacă aveți întrebări, vă rugăm să luați legătura cu serviciul relații clienți. Ne asumăm răspunderea pentru daune numai dacă instrucțiunile de reparare au fost respectate pe deplin.

## 1.2 Explicația simbolurilor

### 1.2.1 Nivelurile de pericol

Nivelurile de alertă sunt reprezentate printr-un simbol și un cuvânt de avertizare. Cuvântul de avertizare indică gravitatea pericolului.





Nivelul de alertă	Semnificație
 <b>PERICOL</b>	Nerespectarea mesajului de avertizare va provoca accidente grave sau decesul.
 <b>AVERTISMENT</b>	Nerespectarea mesajului de avertizare ar putea provoca accidente grave sau decesul.
 <b>ATENȚIONARE</b>	Nerespectarea mesajului de avertizare ar putea provoca accidente ușoare.
<b>ATENȚIE!</b>	Nerespectarea mesajului de avertizare ar putea provoca daune asupra proprietății.

Tabel 1: Nivelurile de pericol



### 1.2.2 Simbolurile de pericol

Simbolurile de pericol sunt reprezentări simbolice care indică tipul de pericol.

În acest document sunt utilizate simbolurile de pericol de mai jos:

Simbol de pericol	Semnificație
	Mesaj de avertizare general
	Pericol din cauza tensiunii electrice
	Pericol de explozie
	Pericol de tăiere
	Pericol de zdrobire

## **i** Referitor la acest document

Simbol de pericol	Semnificație
	Pericol din cauza suprafețelor fierbinți
	Pericol din cauza câmpului magnetic puternic
	Pericol din cauza radiației neionizante

Tabel 2: Simbolurile de pericol

### 1.2.3 Structura avertismentelor

Avertismentele din acest document au un aspect și o structură standard.



	<div style="background-color: red; color: white; padding: 2px; text-align: center;"><b>⚠ PERICOL</b></div> <p><b>Tipul și sursa pericolului!</b> Consecințele posibile ale ignorării pericolului/avertismentului.</p> <ul style="list-style-type: none"> <li>▶ Măsuri și interdicții pentru prevenirea pericolului.</li> </ul>
--	--





Exemplul următor prezintă un avertisment privind electrocutarea din cauza pieselor sub tensiune. Se menționează măsura necesară pentru a evita pericolul.

	<div style="background-color: red; color: white; padding: 2px; text-align: center;"><b>⚠ PERICOL</b></div> <p><b>Pericol de electrocutare din cauza pieselor sub tensiune!</b> Deces prin electrocutare</p> <ul style="list-style-type: none"> <li>▶ Deconectați aparatele de la sursa de alimentare cu tensiune cu cel puțin 60 de secunde înainte de a începe reparațiile.</li> </ul>
---	---

### 1.2.4 Simbolurile generale

În acest document sunt utilizate simbolurile generale de mai jos:

Simbol general	Semnificație
	Identificarea unei recomandări speciale (text și/sau grafică)
	Identificarea unei recomandări simple (numai text)

Simbol general	Semnificație
	Identificarea unui link spre un videoclip instructiv
	Identificarea sculelor necesare
	Identificarea condițiilor preliminare necesare
	Identificarea unei stări (dacă..., apoi...)
	Identificarea unui rezultat
[Pornire]	Identificarea unei taste sau a unui buton
[00123456]	Identificarea unui număr de serie
Stare	Identificarea unui text/unei ferestre afișate (pe ecranul aparatului)

Tabel 3: Simbolurile generale

## 2.1 Instrucțiuni generale de siguranță

### 2.1.1 Toate aparatele electrocasnice

#### **Pericol de electrocutare din cauza pieselor sub tensiune!**

- Erorile care au loc în timpul reparațiilor efectuate la componentele electrice pot să ducă la electrocutări!
- Deconectați aparatul de la sursa de alimentare cu tensiune cu cel puțin 60 de secunde înainte de a începe lucrările.
- După reparație, este obligatorie efectuarea unei verificări de siguranță conform cu VDE 0701 sau cu reglementările naționale respective.

#### **Pericol de rănire din cauza muchiilor ascuțite!**

- Purtați mănuși de protecție.

#### **Pericol de zdrobire în timpul lucrărilor de reparație, întreținere, depanare și service, din cauza componentelor grele și mobile**

- Purtați încălțăminte de protecție.
- Fixați componentele grele împotriva căderii.
- Nu vă sprijiniți cu părți ale corpului de componentele mobile.







#### **Pericol pentru siguranța/funcționarea aparatului!**





- Utilizați numai piese de schimb originale.

#### **Pericol de deteriorare a componentelor sensibile la electricitatea statică (ESD)!**

- Nu atingeți modulele, inclusiv conexiunile și căile conductorilor.

## Instrumente și materiale utile

Desemnare	Detalii	Imagini
Instrumentul auxiliar [15000155]	Instrument pentru slăbirea pieselor din plastic	
Șurubelniță Torx T20 cu orificiu [00340764]	100 mm, pentru șuruburi cu știft de siguranță	
Cheie de cuplu [15000441]	Cheie de cuplu 20 - 100 Nm	
Șurubelniță cu slot [00340854]	Lamă 3,5 mm x 0,6 mm x 100 mm, Izolație protectoare 1000 V CA	
Șurubelniță cu slot [00340855]	Lamă 5,5 mm x 1,0 mm x 125 mm, Izolație protectoare 1000 V CA	
Clește cu cios, model unghiular [00341269]	Lungime 200 mm	
Clește cu tăiere laterală [00342182]	Lungime: 200 mm	



Desemnare	Detalii	Imagini
Cheie fixă inelară [00340811]	Dimensiune cheie 10°mm, M6	
Combination wrench [00340814]	Dimensiune cheie 13°mm, M8	
Cheie fixă inelară [00340817]	Dimensiune cheie 17 mm, M10	
Cheie fixă inelară [15000459]	Dimensiune cheie 16°mm, M10	

## 4.1 Înlocuirea părții superioare

### Scule speciale:

-  Cap Torx TX20 cu orificiu      Lungime 152 mm, lungime utilă [00341272]  
124 mm, șurubelniță hexagonală 1/4"  
(6,35 mm), pentru șuruburi cu știft de  
siguranță

### Cerință:

-  Aparatul este deconectat de la sursa de energie electrică.
-  Aparatul este deconectat de la sursa de alimentare cu apă.

### 4.1.1 Demontarea părții superioare

- ▶ 1. Scoateți șuruburile (1).
- ▶ 2. Împingeți partea superioară către partea din spate a aparatului (2).
- ▶ 3. Mutați în sus partea superioară (3) pentru demontare.

### 4.1.2 Montarea părții superioare



Respectați instrucțiunile de instalare a cablului. Cablu poate fi blocat.

- ▶ Montați urmând procedura de demontare în ordine inversă.

## 4.2 Înlocuirea sertarului pentru detergent

### Cerință:

- ✓ Aparatul este deconectat de la sursa de energie electrică.
- ✓ Aparatul este deconectat de la sursa de alimentare cu apă.

### 4.2.1 Demontarea sertarului pentru detergent

1. Deschideți complet sertarul pentru detergent.
2. 1. Apăsați în jos pe inserție (1).  
2. Scoateți sertarul pentru detergent (2).

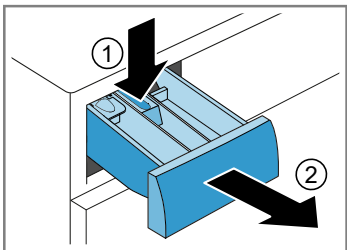

### 4.2.2 Montarea sertarului pentru detergent

- ▶ Montați urmând procedura de demontare în ordine inversă.

## 4.3 Înlocuirea mânerului sertarului pentru detergent

### Cerință:

- ✓ Aparatul este deconectat de la sursa de energie electrică.
- ✓ Aparatul este deconectat de la sursa de alimentare cu apă.
- ✓ [Sertarul pentru detergent a fost demontat.→354](#)

### 4.3.1 Demontarea mânerului sertarului pentru detergent

1. Decuplați elementele de prindere.

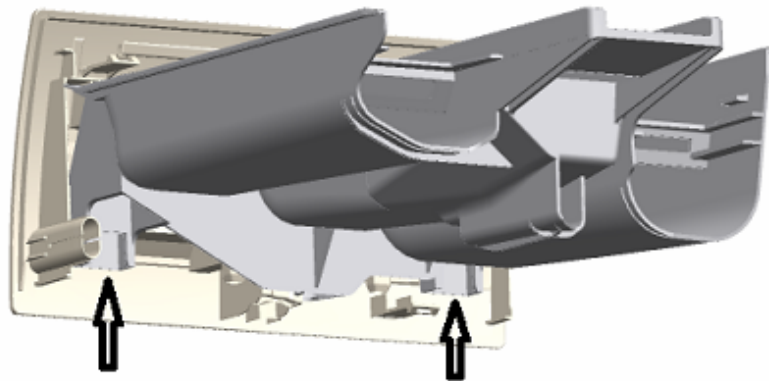

2. Scoateți mânerul sertarului pentru detergent.

### 4.3.2 Montarea mânerului sertarului pentru detergent

- ▶ Montați urmând procedura de demontare în ordine inversă.

## 4.4 Înlocuirea panoului de mascare

În calitate de producător, suntem obligați să le oferim clienților piesa de schimb panou de mascare, inclusiv instrucțiuni de reparare, în conformitate cu regulamentul (UE) 2019/2023. Am dori să subliniem însă, că, după înlocuirea panoului de mascare, este obligatorie efectuarea unei verificări de siguranță electrotehnică de către un electrician calificat înainte ca dispozitivul să poată fi pus în funcțiune. Această persoană trebuie să fie calificată în mod certificabil în conformitate cu legile, reglementările și standardele naționale respective.

	<b>⚠ PERICOL</b>
	<b>Pericol de electrocutare din cauza pieselor sub tensiune!</b> Pericol de moarte prin electrocutare în cazul unei reparații necorespunzătoare <ul style="list-style-type: none"><li>▶ Componentele electrice trebuie reparate de către electricieni calificați.</li><li>▶ După reparație, este obligatorie efectuarea unei verificări de siguranță conform cu VDE 0701 sau cu reglementările naționale respective.</li></ul>

	<b>⚠ AVERTISMENT</b>
	<b>Alunecarea aparatelor înclinate!</b> Fracturi/zdrobiri <ul style="list-style-type: none"><li>▶ Fixați aparatele împotriva alunecării.</li></ul>

	<b>⚠ ATENȚIONARE</b>
	<b>Muchii ascuțiți ale carcasei!</b> Tăieturi <ul style="list-style-type: none"><li>▶ Purtați mănuși de protecție.</li></ul>

	<b>⚠ ATENȚIONARE</b>
	<b>Pericol din cauza pieselor care cad pentru că șuruburile sunt slăbite!</b> Accidente din cauza pieselor care cad. <ul style="list-style-type: none"><li>▶ Fixați componenta împotriva căderii.</li></ul>

	<b>ATENȚIE!</b>
	<b>Pericol din cauza pieselor care cad pentru că șuruburile sunt slăbite!</b> Deteriorarea altor piese ale aparatului sau a casei clientului, de exemplu, partea de jos. <ul style="list-style-type: none"><li>▶ Fixați componenta împotriva căderii.</li></ul>

### Cerință:

- ✓ Aparatul este deconectat de la sursa de energie electrică.
- ✓ Aparatul este deconectat de la sursa de alimentare cu apă.
- ✓ [Partea superioară a fost demontată. → 353](#)
- ✓ [Sertarul pentru detergent a fost demontat. → 354](#)

### 4.4.1 Demontarea panoului de mascare

1. Scoateți șuruburile (1).
2. Decuplați elementele de prindere (2, 3).

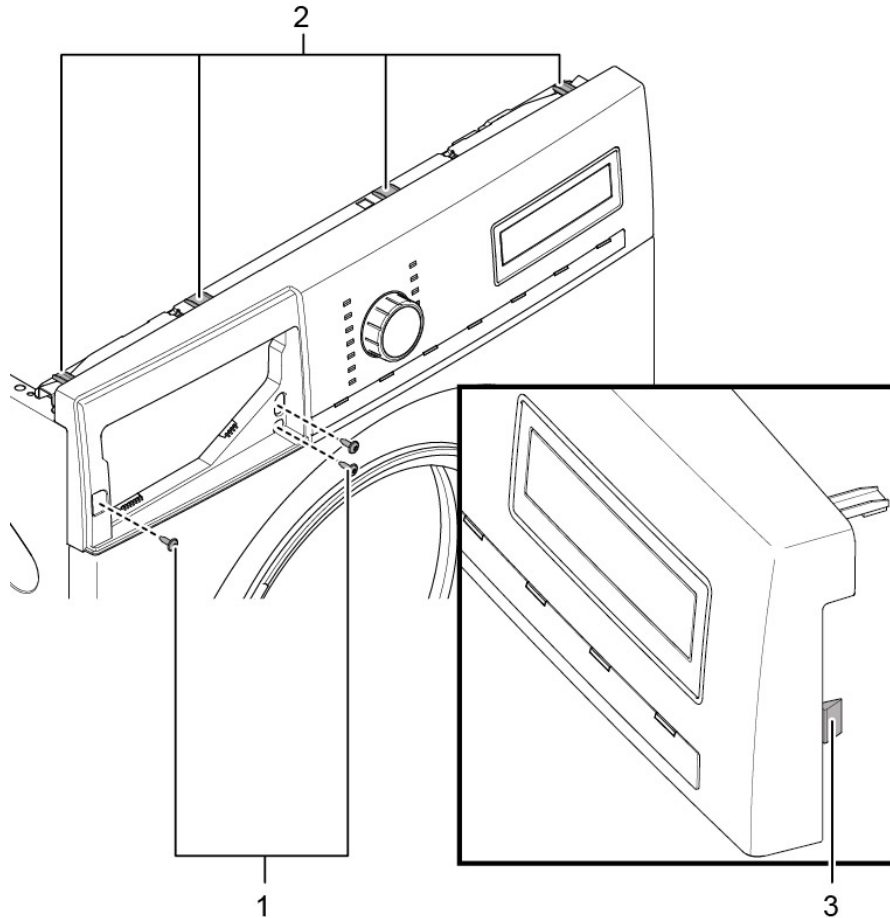

2. Decuplați contactul cu fișe al unității de comandă.
3. Demontați panoul de mascare.

### 4.4.2 Montarea panoului de mascare



Respectați instrucțiunile de instalare a cablului. Cablu poate fi blocat.

- ▶ Montați urmând procedura de demontare în ordine inversă.

## 4.5 Înlocuirea ușii



### ⚠️ ATENȚIONARE

#### Zona balamalei deschise!

Zdrobirea/prinderea degetelor

- ▶ Nu introduceți degetele sau mâna în zona balamalei.
- ▶ Purtați mănuși de protecție.



### ⚠️ ATENȚIONARE

#### Pericol din cauza pieselor care cad pentru că șuruburile sunt slăbite!

Accidente din cauza pieselor care cad.

- ▶ Fixați componenta împotriva căderii.



### ATENȚIE!

#### Pericol din cauza pieselor care cad pentru că șuruburile sunt slăbite!

Deteriorarea altor piese ale aparatului sau a casei clientului, de exemplu, partea de jos.

- ▶ Fixați componenta împotriva căderii.

#### Cerință:

- ✔ Aparatul este deconectat de la sursa de energie electrică.
- ✔ Aparatul este deconectat de la sursa de alimentare cu apă.
- ✔ Ușa este deschisă.

### 4.5.1 Demontarea ușii

1. Scoateți șuruburile (1).

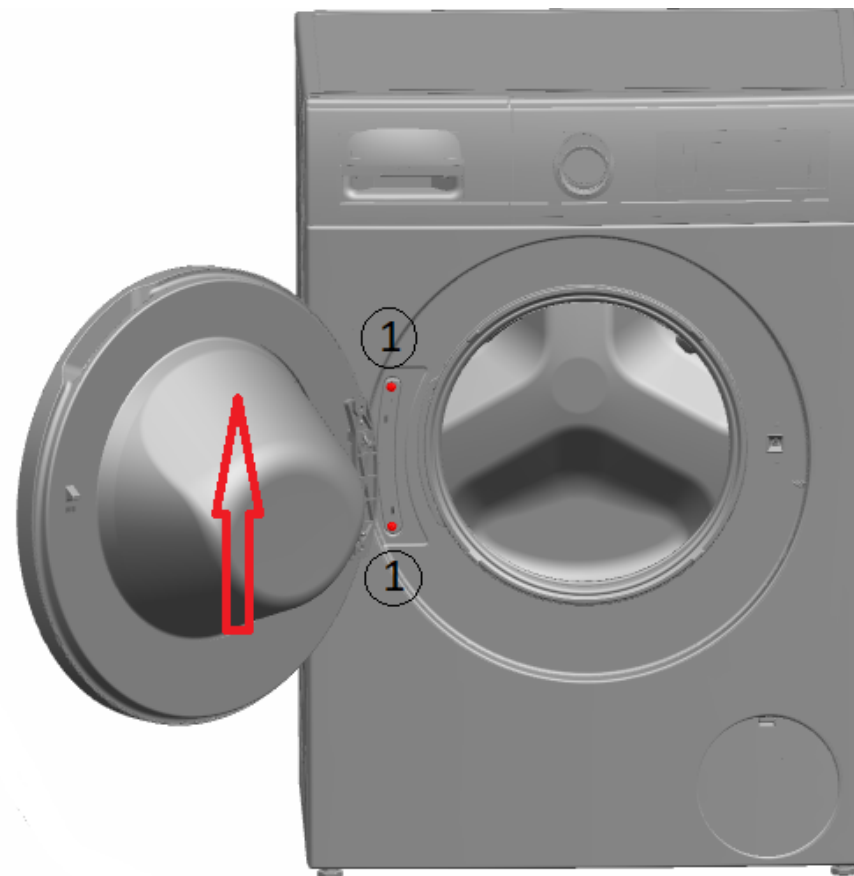



2. Scoateți ușa ridicând-o în sus.

### 4.5.2 Montarea ușii

- ▶ Montați urmând procedura de demontare în ordine inversă.

## 4.6 Înlocuirea componentelor ușii

	<b>⚠ AVERTISMENT</b>
	<b>Componente grele și mobile!</b> Pericol de zdrobire în timpul lucrărilor de reparație, întreținere, depanare și service <ul style="list-style-type: none"><li>▶ Purtați încălțăminte de protecție.</li><li>▶ Fixați componentele grele împotriva căderii.</li><li>▶ Nu vă sprijiniți cu părți ale corpului de componentele mobile.</li></ul>

	<b>⚠ ATENȚIONARE</b>
	<b>Zona balamalei deschise!</b> Zdrobirea/prinderea degetelor <ul style="list-style-type: none"><li>▶ Nu introduceți degetele sau mâna în zona balamalei.</li><li>▶ Purtați mănuși de protecție.</li></ul>

### Cerință:

- ✓ Aparatul este deconectat de la sursa de energie electrică.
- ✓ Aparatul este deconectat de la sursa de alimentare cu apă.
- ✓ [Ușa a fost demontată. → 358](#)

### 4.6.1 Demontarea componentelor ușii

- ▶ Dezasamblați ușa dinspre exterior înspre interior.

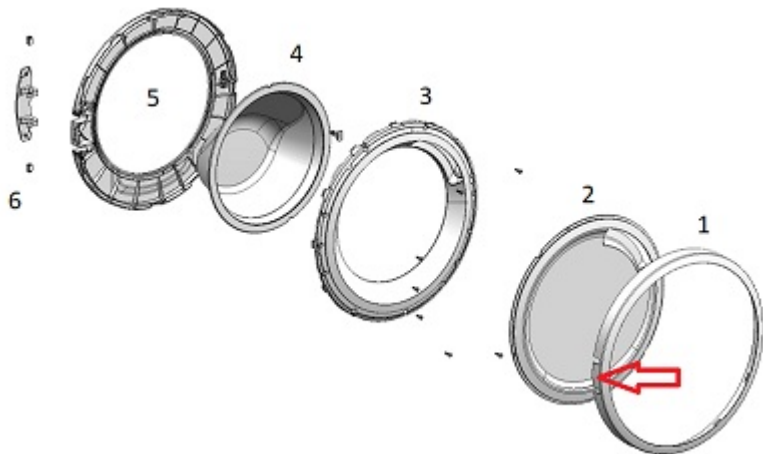

### 4.6.2 Montarea componentelor ușii

- ▶ Montați urmând procedura de demontare în ordine inversă.

## 4.7 Înlocuirea capacului pompei

### Cerință:

- ✓ Aparatul este deconectat de la sursa de energie electrică.
- ✓ Aparatul este deconectat de la sursa de alimentare cu apă.

### 4.7.1 Demontarea capacului pompei

1. Deschideți capacul pompei.

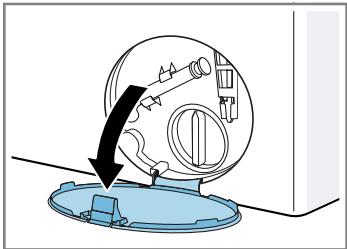

2. Scoateți capacul pompei.

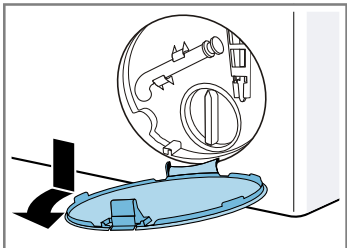

### 4.7.2 Montarea capacului pompei

- ▶ Montați urmând procedura de demontare în ordine inversă.

## 4.8 Înlocuirea garniturii ușii



### ⚠️ ATENȚIONARE

**Muchii ascuțiți ale carcasei!**  
Tăieturi  
▶ Purtați mănuși de protecție.



### ⚠️ ATENȚIONARE

**Pericol din cauza pieselor care cad pentru că șuruburile sunt slăbite!**  
Accidente din cauza pieselor care cad.  
▶ Fixați componenta împotriva căderii.



### ATENȚIE!

**Pericol din cauza pieselor care cad pentru că șuruburile sunt slăbite!**  
Deteriorarea altor piese ale aparatului sau a casei clientului, de exemplu, partea de jos.  
▶ Fixați componenta împotriva căderii.

### Cerință:

- ✔️ Aparatul este deconectat de la sursa de energie electrică.
- ✔️ Aparatul este deconectat de la sursa de alimentare cu apă.
- ✔️ Aparatele sunt accesibile.
- ✔️ [Partea superioară a fost demontată.→353](#)
- ✔️ [Sertarul pentru detergent a fost demontat.→354](#)
- ✔️ [Panoul de mascare a fost demontat.→357](#)
- ✔️ [Ușa a fost demontată.→358](#)
- ✔️ [Capacul pompei a fost demontat.→360](#)
- ✔️ [Panoul frontal a fost demontat.→366](#)
- ✔️ [Iluminarea cuvei a fost demontată \(opțional\).→365](#)

### 4.8.1 Demontarea garniturii ușii

1. Deconectați toate racordurile furtunurilor.

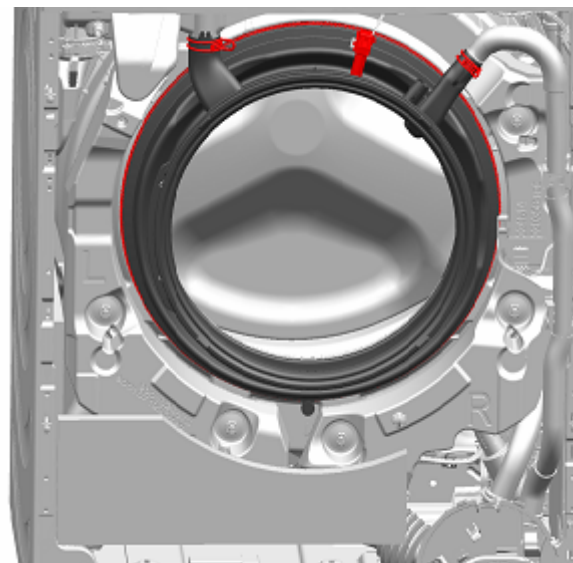

2. Scoateți garnitura ușii.

### 4.8.2 Montarea garniturii ușii



### ⚠️ AVERTISMENT

**Pericol din cauza pieselor în cădere din cauza instalării incorecte!**  
Rănire sau deteriorarea aparatului.  
▶ Strângeți inelul de tensionare din garnitura de cauciuc cu 3,4 Nm.

- ▶ Montați urmând procedura de demontare în ordine inversă.

## 4.9 Înlocuirea dispozitivului de blocare a uşii

În calitate de producător, suntem obligați să le oferim clienților piesa de schimb sistem de blocare pentru uşă, inclusiv instrucțiuni de reparare, în conformitate cu regulamentul (UE) 2019/2023. Am dori să subliniem însă, că, după înlocuirea sistemului de blocare a uşii, este obligatorie efectuarea unei verificări de siguranță electrotehnică de către un electrician calificat înainte ca dispozitivul să poată fi pus în funcțiune. Această persoană trebuie să fie calificată în mod certificabil în conformitate cu legile, reglementările și standardele naționale respective.

	<b>⚠ PERICOL</b>
	<p><b>Pericol de electrocutare din cauza pieselor sub tensiune!</b> Pericol de moarte prin electrocutare în cazul unei reparații necorespunzătoare</p> <ul style="list-style-type: none"> <li>▶ Componentele electrice trebuie reparate de către electricieni calificați.</li> <li>▶ După reparație, este obligatorie efectuarea unei verificări de siguranță conform cu VDE 0701 sau cu reglementările naționale respective.</li> </ul>

	<b>⚠ AVERTISMENT</b>
	<p><b>Alunecarea aparatelor înclinate!</b> Fracturi/zdrobiri</p> <ul style="list-style-type: none"> <li>▶ Fixați aparatele împotriva alunecării.</li> </ul>

	<b>⚠ ATENȚIONARE</b>
	<p><b>Muchii ascuțiți ale carcasei!</b> Tăieturi</p> <ul style="list-style-type: none"> <li>▶ Purtați mănuși de protecție.</li> </ul>

	<b>⚠ ATENȚIONARE</b>
	<p><b>Pericol din cauza pieselor care cad pentru că șuruburile sunt slăbite!</b> Accidente din cauza pieselor care cad.</p> <ul style="list-style-type: none"> <li>▶ Fixați componenta împotriva căderii.</li> </ul>

	<b>ATENȚIE!</b>
	<p><b>Pericol din cauza pieselor care cad pentru că șuruburile sunt slăbite!</b> Deteriorarea altor piese ale aparatului sau a casei clientului, de exemplu, partea de jos.</p> <ul style="list-style-type: none"> <li>▶ Fixați componenta împotriva căderii.</li> </ul>

### Cerință:

- ✓ Aparatul este deconectat de la sursa de energie electrică.
- ✓ Aparatul este deconectat de la sursa de alimentare cu apă.
- ✓ Aparatele sunt accesibile.
- ✓ [Partea superioară a fost demontată.→353](#)
- ✓ [Sertarul pentru detergent a fost demontat.→354](#)
- ✓ [Panoul de mascare a fost demontat.→357](#)
- ✓ [Ușa a fost demontată.→358](#)
- ✓ Inelul de tensionare a fost demontat.
- ✓ [Garnitura uşii a fost demontată.→361](#)
- ✓ [Capacul pompei a fost demontat.→360](#)
- ✓ [Panoul frontal a fost demontat.→366](#)

### 4.9.1 Demontarea dispozitivului de blocare a uşii

1. Deconectați fișa dispozitivului de blocare a uşii.

## Repararea

- Decuplați dispozitivul de blocare a ușii.



- Demontați dispozitivul de blocare a ușii.

### 4.9.2 Montarea dispozitivului de blocare a ușii

Pentru ca deschiderea de urgență a ușii aparatului să funcționeze corespunzător, dispozitivul de blocare a ușii trebuie să fie în poziția corectă.

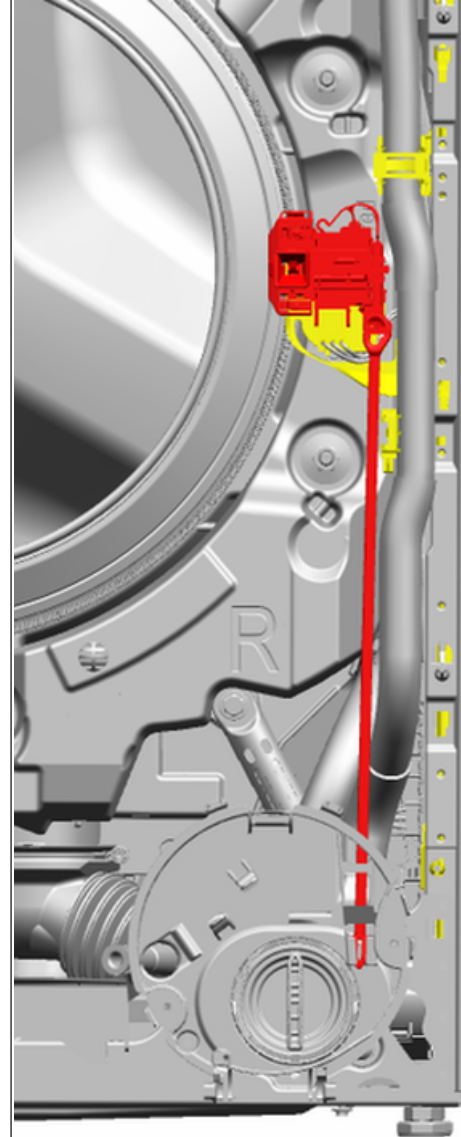

## Repararea

- ▶ Montați urmând procedura de demontare în ordine inversă.

## 4.10 Înlocuirea iluminării cuvei



### AVERTISMENT

**Alunecarea aparatelor înclinate!**

Fracturi/zdrobiri

- ▶ Fixați aparatele împotriva alunecării.



### ATENȚIONARE

**Muchii ascuțiți ale carcasei!**

Tăieturi

- ▶ Purtați mănuși de protecție.



### ATENȚIONARE

**Pericol din cauza pieselor care cad pentru că șuruburile sunt slăbite!**

Accidente din cauza pieselor care cad.

- ▶ Fixați componenta împotriva căderii.









### ATENȚIE!

**Pericol din cauza pieselor care cad pentru că șuruburile sunt slăbite!**

Deteriorarea altor piese ale aparatului sau a casei clientului, de exemplu, partea de jos.

- ▶ Fixați componenta împotriva căderii.

### Cerință:

-  Aparatul este deconectat de la sursa de energie electrică.
-  Aparatul este deconectat de la sursa de alimentare cu apă.
-  Aparatele sunt accesibile.
-  [Partea superioară a fost demontată.→353](#)
-  [Sertarul pentru detergent a fost demontat.→354](#)
-  [Panoul de mascare a fost demontat.→357](#)

## 4.10.1 Demontarea iluminării cuvei

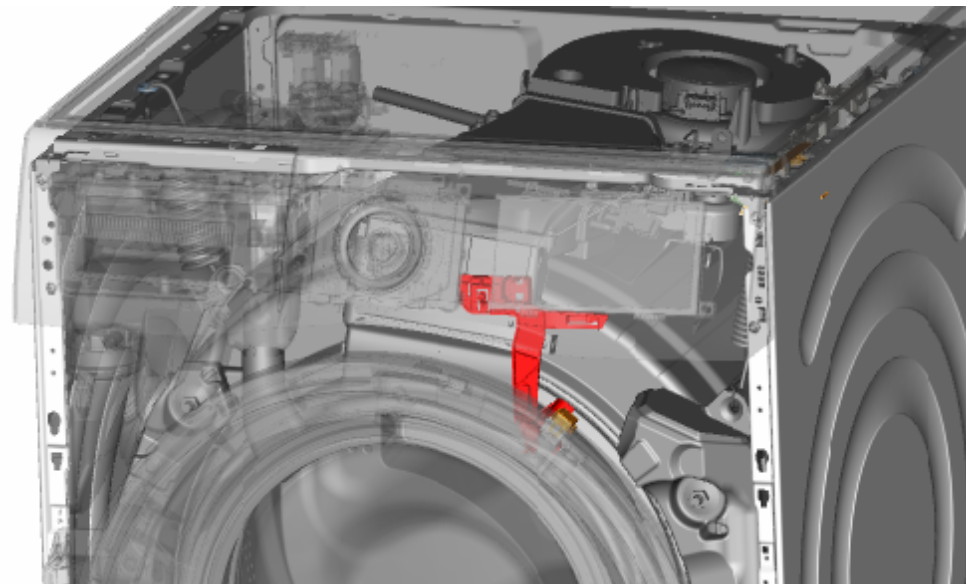

1. Trageți suportul iluminării cuvei afară din aparat.
2. Deconectați conexiunile electrice.
3. Demontați iluminarea cuvei din suport.

## 4.10.2 Montarea iluminării cuvei



Respectați instrucțiunile de instalare a cablului. Cablu poate fi blocat.

- ▶ Montați urmând procedura de demontare în ordine inversă.

## 4.11 Înlocuirea panoului frontal



### ⚠️ AVERTISMENT

**Alunecarea aparatelor înclinate!**

Fracturi/zdrobiri

- ▶ Fixați aparatele împotriva alunecării.



### ⚠️ ATENȚIONARE

**Muchii ascuțiți ale carcasei!**

Tăieturi

- ▶ Purtați mănuși de protecție.



### ⚠️ ATENȚIONARE

**Pericol din cauza pieselor care cad pentru că șuruburile sunt slăbite!**

Accidente din cauza pieselor care cad.

- ▶ Fixați componenta împotriva căderii.



### ⚠️ ATENȚIE!

**Pericol din cauza pieselor care cad pentru că șuruburile sunt slăbite!**

Deteriorarea altor piese ale aparatului sau a casei clientului, de exemplu, partea de jos.

- ▶ Fixați componenta împotriva căderii.

### Cerință:

- ✔️ Aparatul este deconectat de la sursa de energie electrică.
- ✔️ Aparatul este deconectat de la sursa de alimentare cu apă.
- ✔️ Aparatele sunt accesibile.
- ✔️ [Partea superioară a fost demontată. → 353](#)
- ✔️ [Sertarul pentru detergent a fost demontat. → 354](#)
- ✔️ [Panoul de mascare a fost demontat. → 357](#)
- ✔️ [Ușa a fost demontată. → 358](#)
- ✔️ [Capacul pompei a fost demontat. → 360](#)
- ✔️ Inelul de tensionare a fost demontat.
- ✔️ Garnitura ușii a fost eliberată în partea din față.
- ✔️ [Iluminarea cuvei a fost demontată \(opțional\). → 365](#)

### 4.11.1 Demontarea panoului frontal

1. Ridicați aparatul de partea din față.
2. Scoateți șuruburile din partea inferioară (1).

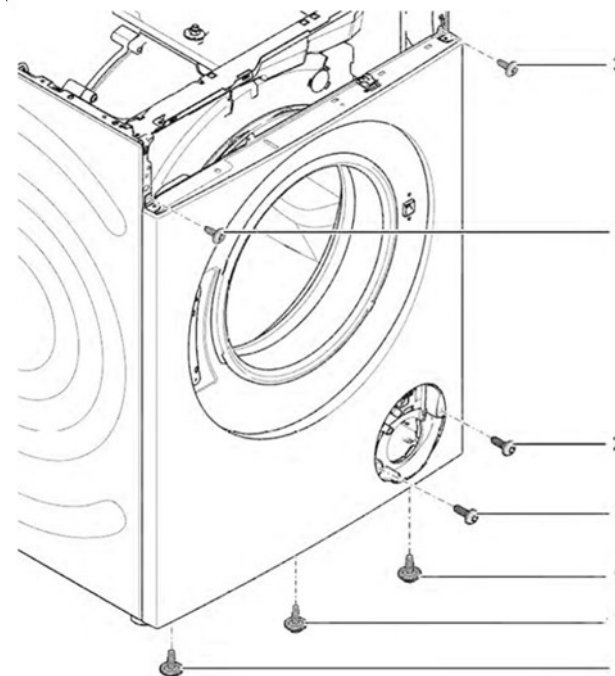

3. Coborâți aparatul.

4. Scoateți șuruburile din față, de jos în sus (2, 3).

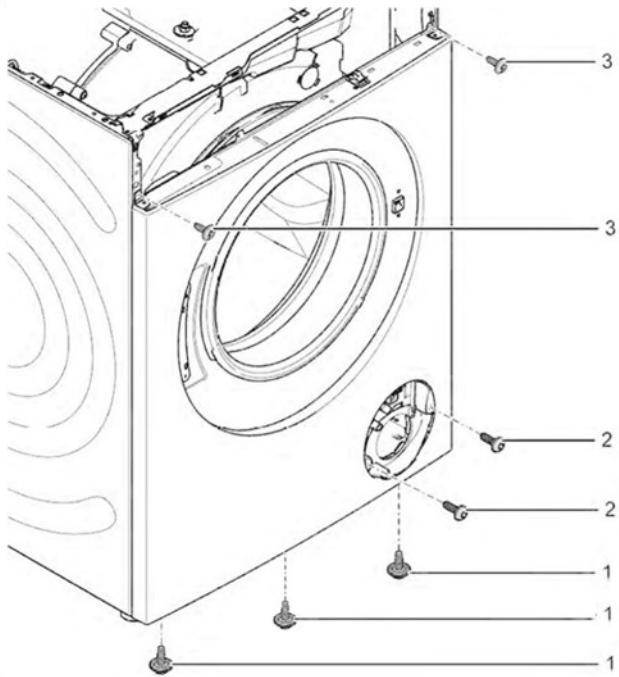

5. Demontați panoul frontal.

### 4.11.2 Montarea panoului frontal

► Montați urmând procedura de demontare în ordine inversă.

# Poznámky k opravám - Práčka

 <b>O tomto dokumente</b> .....	<b>369</b>
1.1 Dôležité informácie .....	369
1.1.1 Účel .....	369
1.2 Vysvetlenie symbolov .....	369
1.2.1 Úrovne nebezpečenstva .....	369
1.2.2 Symboly označujúce riziká .....	369
1.2.3 Štruktúra varovaní .....	370
1.2.4 Všeobecné symboly .....	370
 <b>Bezpečnosť</b> .....	<b>371</b>
2.1 Všeobecné bezpečnostné pokyny .....	371
2.1.1 Všetky domáce spotrebiče .....	371
 <b>Nástroje a pomôcky</b> .....	<b>372</b>
 <b>Oprava</b> .....	<b>373</b>
4.1 Výmena pracovnej plochy .....	373
4.1.1 Odoberanie pracovnej plochy .....	373
4.1.2 Montáž pracovnej plochy .....	373
4.2 Výmena zásuvky na prací prostriedok .....	374
4.2.1 Odstránenie zásuvky na prací prostriedok .....	374
4.2.2 Montáž zásuvky na prací prostriedok .....	374
4.3 Výmena držadla zásuvky na prací prostriedok .....	375
4.3.1 Odstránenie držadla zásuvky na prací prostriedok .....	375
4.3.2 Montáž držadla zásuvky na prací prostriedok .....	375
4.4 Výmena panelu obloženia .....	376
4.4.1 Odstránenie panelu obloženia .....	376
4.4.2 Montáž panelu obloženia .....	377
4.5 Výmena dverí .....	378
4.5.1 Odoberanie dverí .....	378
4.5.2 Montáž dverí .....	378
4.6 Výmena komponentov dverí .....	379
4.6.1 Odoberanie komponentov dverí .....	379
4.6.2 Montáž komponentov dverí .....	379
4.7 Výmena krytu čerpadla .....	380
4.7.1 Odoberanie krytu čerpadla .....	380
4.7.2 Montáž krytu čerpadla .....	380

4.8 Výmena tesnenia dverí .....	381
4.8.1 Odoberanie tesnenia dverí .....	381
4.8.2 Montáž tesnenia dverí .....	381
4.9 Výmena poistky dvierok .....	382
4.9.1 Odoberanie poistky dvierok .....	382
4.9.2 Montáž poistky dvierok .....	383
4.10 Výmena osvetlenia bubna .....	384
4.10.1 Odoberanie osvetlenia bubna .....	384
4.10.2 Montáž osvetlenia bubna .....	384
4.11 Výmena čelného panela .....	385
4.11.1 Odstránenie čelného panela .....	385
4.11.2 Montáž čelného panela .....	386

# **i** O tomto dokumente

## 1.1 Dôležité informácie

### 1.1.1 Účel

Tieto pokyny pre opravu pomáhajú spotrebiteľovi pri vlastnej oprave spotrebičov podľa nariadenia o ekodizajne (z marca 2021).

Obsahujú informácie o výmene určených náhradných dielov vrátane varovaní a rizík.

Ak máte otázky, kontaktujte náš zákaznícky servis. Za poškodenia ručíme len vtedy, ak pokyny boli dodržané správne.

## 1.2 Vysvetlenie symbolov

### 1.2.1 Úrovne nebezpečenstva

Úroveň varovania obsahuje symbol a signalizačné slovo. Signalizačné slovo naznačuje mieru nebezpečenstva.





Úroveň varovania	Význam
 <b>NEBEZPEČENSTVO</b>	Následkom nerešpektovania varovného hlásenia je úmrtie alebo vážne zranenia.
 <b>VAROVANIE</b>	Možným následkom nerešpektovania varovného hlásenia je úmrtie alebo vážne zranenia.
 <b>UPOZORNENIE</b>	Možným následkom nerešpektovania varovného hlásenia sú mierne zranenia.
 <b>POZOR!</b>	Možným následkom nerešpektovania varovného hlásenia je poškodenie majetku.

Tabuľka 1: Úrovne nebezpečenstva



### 1.2.2 Symboly označujúce riziká

Symboly označujúce riziká sú symbolické znázornenia, ktoré naznačujú druh nebezpečenstva.

V tomto dokumente sa používajú nasledujúce symboly označujúce riziká:

Symbol označujúci riziko	Význam
	Všeobecné varovné hlásenie
	Nebezpečenstvo v súvislosti s elektrickým napätím
	Nebezpečenstvo výbuchu
	Nebezpečenstvo porezania
	Nebezpečenstvo pomliaždenia

## **i** O tomto dokumente

Symbol označujúci riziko	Význam
	Nebezpečenstvo v súvislosti s horúcimi povrchmi
	Nebezpečenstvo v súvislosti s magnetickým poľom
	Nebezpečenstvo v súvislosti s neionizujúcou radiáciou

Tabuľka 2: Symboly označujúce riziká

### 1.2.3 Štruktúra varovaní

Varovania v tomto dokumente majú štandardný vzhľad a štandardnú štruktúru.



	<p><b>⚠ NEBEZPEČENSTVO</b></p> <p><b>Druh a zdroj nebezpečenstva!</b> Možné následky pri ignorovaní nebezpečenstva/varovania.</p> <ul style="list-style-type: none"> <li>▶ Opatrenia a zákazy na zabránenie nebezpečenstvu.</li> </ul>
--	--





Nasledujúci príklad znázorňuje varovanie pred zásahom elektrickým prúdom pri dotyku s časťami pod napätím. Je uvedené opatrenie na predídenie nebezpečenstvu.

	<p><b>⚠ NEBEZPEČENSTVO</b></p> <p><b>Nebezpečenstvo úrazu elektrickým prúdom pri dotyku s časťami pod napätím!</b> Úmrtie v dôsledku zásahu elektrickým prúdom</p> <ul style="list-style-type: none"> <li>▶ Odpojte spotrebiče od elektrického zdroja aspoň 60 sekúnd pred začiatkom opráv.</li> </ul>
---	--

### 1.2.4 Všeobecné symboly

V tomto dokumente sa používajú nasledujúce všeobecné symboly:

Všeob. symbol	Význam
	Označenie špeciálneho pokynu (textové a/alebo grafické)
	Označenie jednoduchého pokynu (len textové)

Všeob. symbol	Význam
	Označenie prepojenia na videonávod
	Označenie požadovaných nástrojov
	Označenie požadovaných podmienok
	Označenie podmienky (ak ..., potom ...)
	Označenie výsledku
[Spustenie]	Označenie klávesu alebo tlačidla
[00123456]	Označenie čísla materiálu
Stav	Označenie zobrazeného textu/okna (na displeji spotrebiča)

Tabuľka 3: Všeobecné symboly

## **2.1 Všeobecné bezpečnostné pokyny**

### **2.1.1 Všetky domáce spotrebiče**

#### **Nebezpečenstvo úrazu elektrickým prúdom pri dotyku s časťami pod napätím!**

- Chyby pri opravách na elektrických komponentoch môžu spôsobiť zásah elektrickým prúdom!
- Odpojte spotrebič od elektrickej siete aspoň 60 sekúnd pred začiatkom práce.
- Po oprave zariadenia vykonajte bezpečnostný test v súlade s nariadením VDE 0701 alebo s miestnymi nariadeniami.

#### **Riziko poranenia na ostrých hranách!**

- Noste ochranné rukavice.

#### **Riziko pomliaždenia počas opravy, údržby, riešenia problémov a servisu na ťažkých a pohybujúcich sa komponentoch**

- Noste ochrannú obuv.
- Zaisťte ťažké komponenty proti pádu.
- Nesiahajte končatinami do pohybujúcich sa komponentov.







#### **Riziko ohrozenia bezpečnosti/funkčnosti spotrebiča!**





- Používajte len originálne náhradné diely.

#### **Riziko poškodenia elektrostaticky citlivých komponentov (ESD)!**

- Nedotýkajte sa modulov vrátane prípojok a vedení vodičov.

## Nástroje a pomôcky

Označenie	Detaily	Snímky
Pomocný nástroj [15000155]	Nástroj na uvoľnenie plastových častí	
Skrutkovač Torx T20 s otvorom [00340764]	100 mm, pre skrutky s bezpečnostným čapom	
Momentový kľúč [15000441]	Momentový kľúč 20 – 100 Nm	
Plochý skrutkovač [00340854]	Čepeľ 3,5 mm x 0,6 mm x 100 mm, ochranná izolácia 1000 V AC	
Plochý skrutkovač [00340855]	Čepeľ 5,5 mm x 1,0 mm x 125 mm, ochranná izolácia 1 000 V AC	
Kliešte zahnuté, špicaté [00341269]	Dĺžka 200 mm	
Bočné štípacie kliešte [00342182]	Dĺžka: 200 mm	



Označenie	Detaily	Snímky
Kombinovaný kľúč [00340811]	Veľkosť kľúča 10°mm, M6	
Combination wrench [00340814]	Veľkosť kľúča 13°mm, M8	
Kombinovaný kľúč [00340817]	Veľkosť kľúča 17 mm, M10	
Kombinovaný kľúč [15000459]	Veľkosť kľúča 16°mm, M10	

## 4.1 Výmena pracovnej plochy

### Špeciálne nástroje:

-  Bit Torx TX20 s otvorom      Dĺžka 152 mm, užitočná dĺžka 124 mm, 1/4" šesťhranný skrutkovač (6,35 mm), pre skrutky s bezpečnostným čapom      [00341272]

### Požiadavka:

-  Spotrebič je odpojený od elektrického napájania.
-  Spotrebič je odpojený od zdroja vody.

### 4.1.1 Odobratie pracovnej plochy

- ▶ 1. Odstráňte skrutky (1).
- ▶ 2. Zatlačte pracovnú plochu do zadnej časti spotrebiča (2).
- ▶ 3. Odstráňte pracovnú plochu posunutím nahor (3).

### 4.1.2 Montáž pracovnej plochy



Dbajte na montáž kábla. Kábel môže byť zaseknutý.

- ▶ Pri montáži postupujte v opačnom poradí krokov demontáže.

## 4.2 Výmena zásuvky na prací prostriedok

### Požiadavka:

- ✔ Spotrebič je odpojený od elektrického napájania.
- ✔ Spotrebič je odpojený od zdroja vody.

### 4.2.1 Odstránenie zásuvky na prací prostriedok

1. Vytiahnite zásuvku na prací prostriedok.
2. 1. Zatlačte na vložku (1).
2. Odoberte zásuvku na prací prostriedok (2).

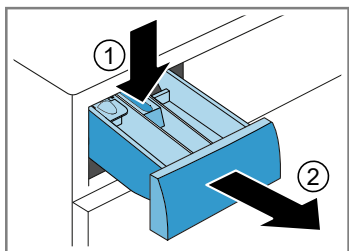

### 4.2.2 Montáž zásuvky na prací prostriedok

- ▶ Pri montáži postupujte v opačnom poradí krokov demontáže.

## 4.3 Výmena držadla zásuvky na prací prostriedok

### Požiadavka:

- ✔ Spotrebič je odpojený od elektrického napájania.
- ✔ Spotrebič je odpojený od zdroja vody.
- ✔ [Zásuvka na prací prostriedok bola odobratá.→374](#)

### 4.3.1 Odstránenie držadla zásuvky na prací prostriedok

1. Uvoľnite zachytávacie prvky.

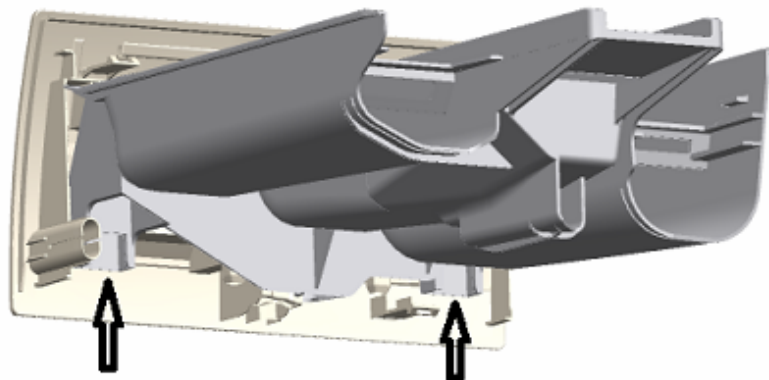

2. Odoberte držadlo zásuvky na prací prostriedok.

### 4.3.2 Montáž držadla zásuvky na prací prostriedok

- ▶ Pri montáži postupujte v opačnom poradí krokov demontáže.

## 4.4 Výmena panelu obloženia

Ako výrobca sme povinní poskytnúť zákazníkovi náhradný diel – panel obloženia – vrátane pokynov k oprave v súlade s nariadením (EÚ) 2019/2023. Chceli by sme však podotknúť, že po výmene panelu obloženia sa pred uvedením spotrebiča do prevádzky vyžaduje test elektrotechnickej bezpečnosti, ktorý vykoná kvalifikovaný elektrikár. Kvalifikáciu tejto osoby musí byť možné overiť podľa miestnych zákonov, regulácií a nariadení.

	<b>⚠ NEBEZPEČENSTVO</b>
	<p><b>Nebezpečenstvo úrazu elektrickým prúdom pri dotyku s časťami pod napätím!</b> Ohrozenie života spôsobené elektrickým zásahom v prípade nesprávnej opravy</p> <ul style="list-style-type: none"> <li>▶ Elektrické diely má opravovať kvalifikovaný elektrikár.</li> <li>▶ Po oprave zariadenie vykonať bezpečnostný test v súlade s nariadením VDE 0701 alebo s miestnymi nariadeniami.</li> </ul>

	<b>⚠ VAROVANIE</b>
	<p><b>Zošmyknutie naklonených spotrebičov!</b> Zlomeniny/pomliaždenia</p> <ul style="list-style-type: none"> <li>▶ Zaistíte spotrebiče proti zošmyknutiu.</li> </ul>

	<b>⚠ UPOZORNENIE</b>
	<p><b>Ostré hrany plášťa!</b> Rezné poranenia</p> <ul style="list-style-type: none"> <li>▶ Noste ochranné rukavice.</li> </ul>

	<b>⚠ UPOZORNENIE</b>
	<p><b>Riziko pádu dielov po uvoľnení skrutiek!</b> Zranenie padajúcimi dielmi.</p> <ul style="list-style-type: none"> <li>▶ Zaistíte komponent proti pádu.</li> </ul>

	<b>POZOR!</b>
	<p><b>Riziko pádu dielov po uvoľnení skrutiek!</b> Poškodenie iných častí spotrebiča alebo domácnosti zákazníka, napr. podlahy.</p> <ul style="list-style-type: none"> <li>▶ Zaistíte komponent proti pádu.</li> </ul>

### Požiadavka:

- ✓ Spotrebič je odpojený od elektrického napájania.
- ✓ Spotrebič je odpojený od zdroja vody.
- ✓ [Pracovná plocha bola odobratá.→373](#)
- ✓ [Zásuvka na prací prostriedok bola odobratá.→374](#)

### 4.4.1 Odstránenie panelu obloženia

1. 1. Odstráňte skrutky (1).
2. Uvoľnite zachytávací prvky (2, 3).

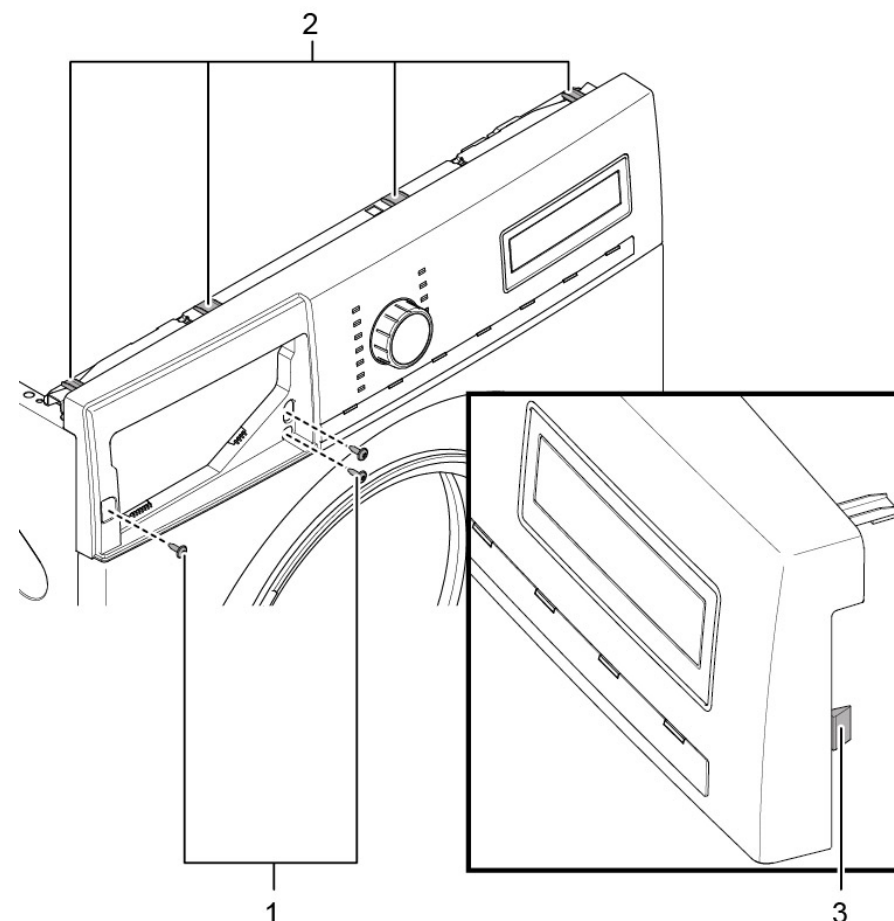

2. Uvoľnite kontakt zástrčky riadiacej jednotky.
3. Odoberte panel obloženia.

### 4.4.2 Montáž panelu obloženia



Dbajte na montáž kábla. Kábel môže byť zaseknutý.

- ▶ Pri montáži postupujte v opačnom poradí krokov demontáže.

## 4.5 Výmena dverí



### UPOZORNENIE

#### Otvorte oblasť závesov!

Pomliaždenie/zachytenie prstov

- ▶ Nesiahajte do priestoru závesov.
- ▶ Noste ochranné rukavice.



### UPOZORNENIE

#### Riziko pádu dielov po uvoľnení skrutiek!

Zranenie padajúcimi dielmi.

- ▶ Zaistite komponent proti pádu.



### POZOR!

#### Riziko pádu dielov po uvoľnení skrutiek!

Poškodenie iných častí spotrebiča alebo domácnosti zákazníka, napr. podlahy.

- ▶ Zaistite komponent proti pádu.

#### Požiadavka:

- ✔ Spotrebič je odpojený od elektrického napájania.
- ✔ Spotrebič je odpojený od zdroja vody.
- ✔ Dvere sú otvorené.

### 4.5.1 Odoberanie dverí

1. Odstráňte skrutky (1).

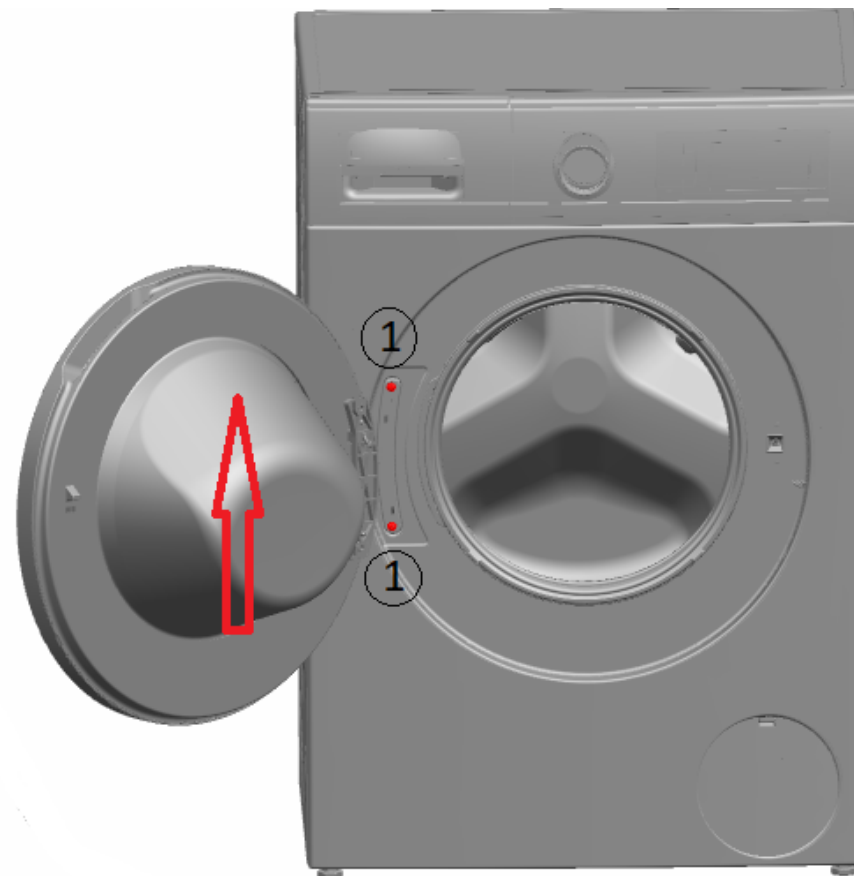



2. Odoberte dvere smerom nahor.

### 4.5.2 Montáž dverí

- ▶ Pri montáži postupujte v opačnom poradí krokov demontáže.

## 4.6 Výmena komponentov dverí

	<p><b>VAROVANIE</b></p> <p><b>Ťažké a pohyblivé komponenty!</b> Riziko pomliaždenia počas opravy, údržby, riešenia problémov a servisu</p> <ul style="list-style-type: none"><li>▶ Noste ochrannú obuv.</li><li>▶ Zaistite ťažké komponenty proti pádu.</li><li>▶ Nesiahajte končatinami do pohybujúcich sa komponentov.</li></ul>
--	--

	<p><b>UPOZORNENIE</b></p> <p><b>Otvorte oblasť závesov!</b> Pomliaždenie/zachytenie prstov</p> <ul style="list-style-type: none"><li>▶ Nesiahajte do priestoru závesov.</li><li>▶ Noste ochranné rukavice.</li></ul>
--	--

### Požiadavka:

- ✔ Spotrebič je odpojený od elektrického napájania.
- ✔ Spotrebič je odpojený od zdroja vody.
- ✔ [Dvere boli odobraté.→378](#)

### 4.6.1 Odoberanie komponentov dverí

- ▶ Odmontujte dvere zvonku do vnútra.

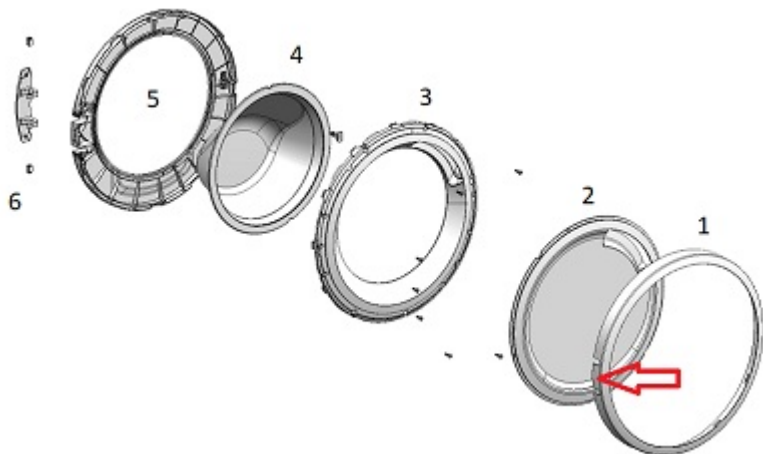

### 4.6.2 Montáž komponentov dverí

- ▶ Pri montáži postupujte v opačnom poradí krokov demontáže.

## 4.7 Výmena krytu čerpadla

### Požiadavka:

- ✔ Spotrebič je odpojený od elektrického napájania.
- ✔ Spotrebič je odpojený od zdroja vody.

### 4.7.1 Odoberanie krytu čerpadla

1. Otvorte kryt čerpadla.

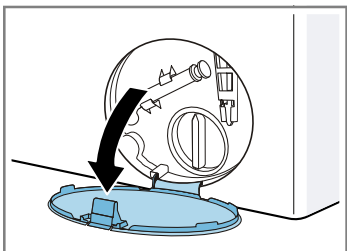

2. Odstráňte kryt čerpadla.

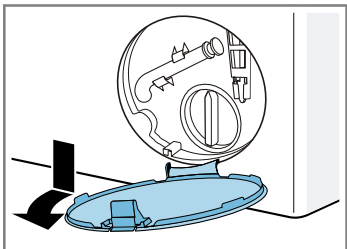

### 4.7.2 Montáž krytu čerpadla

- ▶ Pri montáži postupujte v opačnom poradí krokov demontáže.

## 4.8 Výmena tesnenia dverí



### UPOZORNENIE

**Ostré hrany plášt'a!**  
Rezné poranenia  
▶ Noste ochranné rukavice.



### UPOZORNENIE

**Riziko pádu dielov po uvoľnení skrutiek!**  
Zranenie padajúcimi dielmi.  
▶ Zaistite komponent proti pádu.



### POZOR!

**Riziko pádu dielov po uvoľnení skrutiek!**  
Poškodenie iných častí spotrebiča alebo domácnosti zákazníka, napr. podlahy.  
▶ Zaistite komponent proti pádu.

#### Požiadavka:

- ✔ Spotrebič je odpojený od elektrického napájania.
- ✔ Spotrebič je odpojený od zdroja vody.
- ✔ Spotrebič je voľne dostupný.
- ✔ [Pracovná plocha bola odobratá.→373](#)
- ✔ [Zásuvka na prací prostriedok bola odobratá.→374](#)
- ✔ [Panel obloženia bol odobratý.→376](#)
- ✔ [Dvere boli odobraté.→378](#)
- ✔ [Kryt čerpadla bol odobratý.→380](#)
- ✔ [Čelný panel bol odobratý.→385](#)
- ✔ [Osvetlenie bubna \(voliteľné\) je odobraté.→384](#)

### 4.8.1 Odoberanie tesnenia dverí

1. Uvoľnite všetky hadicové prípojky.

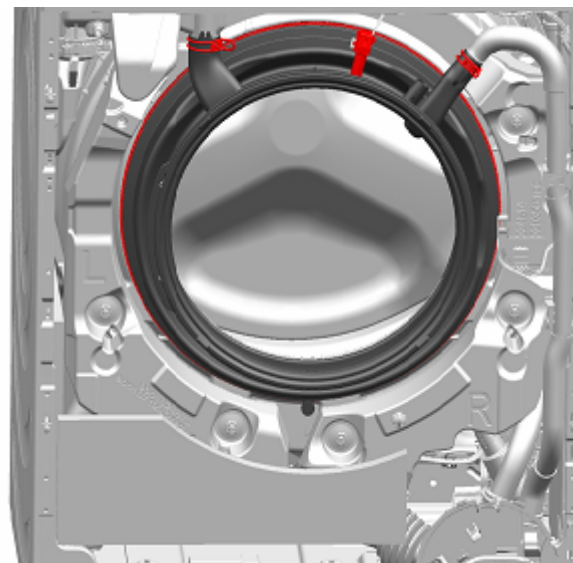

2. Odoberte tesnenie dverí.

### 4.8.2 Montáž tesnenia dverí



### VAROVANIE

**Riziko pádu dielov po nesprávnej inštalácii!**  
Zranenie alebo poškodenie spotrebiča.  
▶ Pritiahnite napínací krúžok manžety do dverí práčky na 3,4 Nm.

- ▶ Pri montáži postupujte v opačnom poradí krokov demontáže.

## 4.9 Výmena poistky dvierok

Ako výrobca sme povinní poskytnúť zákazníkovi náhradný diel – poistka dvierok - vrátane pokynov k oprave v súlade s nariadením (EÚ) 2019/2023. Chceli by sme však podotknúť, že po výmene poistky dvierok sa pred uvedením spotrebiča do prevádzky vyžaduje test elektrotechnickej bezpečnosti, ktorý vykoná kvalifikovaný elektrikár. Kvalifikáciu tejto osoby musí byť možné overiť podľa miestnych zákonov, regulácií a nariadení.

	<b>⚠ NEBEZPEČENSTVO</b>
	<p><b>Nebezpečenstvo úrazu elektrickým prúdom pri dotyku s časťami pod napätím!</b>                  Ohrozenie života spôsobené elektrickým zásahom v prípade nesprávnej opravy</p> <ul style="list-style-type: none"> <li>▶ Elektrické diely má opravovať kvalifikovaný elektrikár.</li> <li>▶ Po oprave zariadenie vykonať bezpečnostný test v súlade s nariadením VDE 0701 alebo s miestnymi nariadeniami.</li> </ul>

	<b>⚠ VAROVANIE</b>
	<p><b>Zošmyknutie naklonených spotrebičov!</b>                  Zlomeniny/pomliaždenia</p> <ul style="list-style-type: none"> <li>▶ Zaistíte spotrebiče proti zošmyknutiu.</li> </ul>

	<b>⚠ UPOZORNENIE</b>
	<p><b>Ostré hrany plášťa!</b>                  Rezné poranenia</p> <ul style="list-style-type: none"> <li>▶ Noste ochranné rukavice.</li> </ul>

	<b>⚠ UPOZORNENIE</b>
	<p><b>Riziko pádu dielov po uvoľnení skrutiek!</b>                  Zranenie padajúcimi dielmi.</p> <ul style="list-style-type: none"> <li>▶ Zaistíte komponent proti pádu.</li> </ul>

	<b>POZOR!</b>
	<p><b>Riziko pádu dielov po uvoľnení skrutiek!</b>                  Poškodenie iných častí spotrebiča alebo domácnosti zákazníka, napr. podlahy.</p> <ul style="list-style-type: none"> <li>▶ Zaistíte komponent proti pádu.</li> </ul>

### Požiadavka:

- ✔ Spotrebič je odpojený od elektrického napájania.
- ✔ Spotrebič je odpojený od zdroja vody.
- ✔ Spotrebič je voľne dostupný.
- ✔ [Pracovná plocha bola odobratá.→373](#)
- ✔ [Zásuvka na prací prostriedok bola odobratá.→374](#)
- ✔ [Panel obloženia bol odobratý.→376](#)
- ✔ [Dvere boli odobraté.→378](#)
- ✔ Napínací krúžok bol odobratý.
- ✔ [Tesnenie dverí boli odobraté.→381](#)
- ✔ [Kryt čerpadla bol odobratý.→380](#)
- ✔ [Čelný panel bol odobratý.→385](#)

### 4.9.1 Odoberanie poistky dvierok

1. Odpojte zástrčku poistky dvierok.
2. Uvoľnite poistku dvierok.



3. Odoberte poistku dvierok.

### 4.9.2 Montáž poistky dvierok

Poistka dvierok musí byť v správnej polohe, aby bola zabezpečená funkcia núdzového otvárania dvierok spotrebiča.

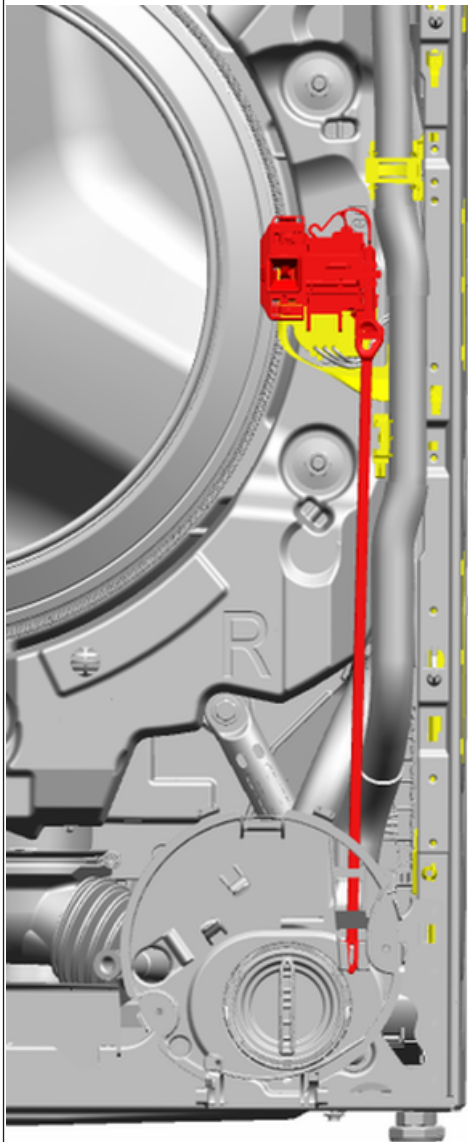

- ▶ Pri montáži postupujte v opačnom poradí krokov demontáže.

## 4.10 Výmena osvetlenia bubna



### **VAROVANIE**

**Zošmyknutie naklonených spotrebičov!**  
Zlomeniny/pomliaždenia  
▶ Zaistite spotrebiče proti zošmyknutiu.



### **UPOZORNENIE**

**Ostré hrany plášťa!**  
Rezné poranenia  
▶ Noste ochranné rukavice.



### **UPOZORNENIE**







**Riziko pádu dielov po uvoľnení skrutiek!**  
Zranenie padajúcimi dielmi.  
▶ Zaistite komponent proti pádu.



### **POZOR!**

**Riziko pádu dielov po uvoľnení skrutiek!**  
Poškodenie iných častí spotrebiča alebo domácnosti zákazníka, napr. podlahy.  
▶ Zaistite komponent proti pádu.

#### Požiadavka:

-  Spotrebič je odpojený od elektrického napájania.
-  Spotrebič je odpojený od zdroja vody.
-  Spotrebič je voľne dostupný.
-  [Pracovná plocha bola odobratá.→373](#)
-  [Zásuvka na prací prostriedok bola odobratá.→374](#)
-  [Panel obloženia bol odobratý.→376](#)

### 4.10.1 Odoberanie osvetlenia bubna

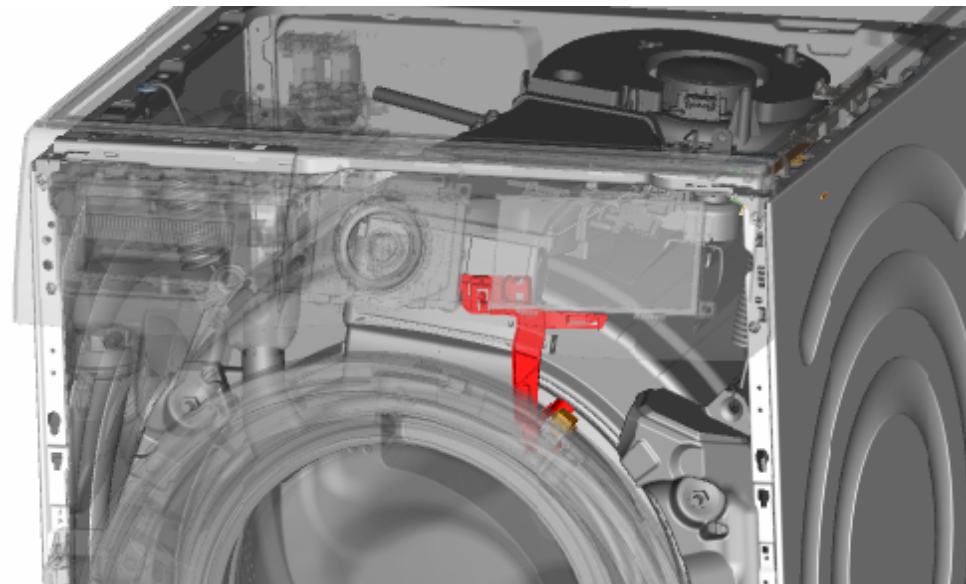

1. Vytiahnite držiak osvetlenia bubna spotrebiča.
2. Odpojte elektrické pripojenia.
3. Odoberte osvetlenie bubna z držiaka osvetlenia bubna.

### 4.10.2 Montáž osvetlenia bubna



Dbajte na montáž kábla. Kábel môže byť zaseknutý.

- ▶ Pri montáži postupujte v opačnom poradí krokov demontáže.

## 4.11 Výmena čelného panela



### **VAROVANIE**

**Zošmyknutie naklonených spotrebičov!**  
Zlomeniny/pomliaždenia  
▶ Zaistite spotrebiče proti zošmyknutiu.



### **UPOZORNENIE**

**Ostré hrany plášťa!**  
Rezné poranenia  
▶ Noste ochranné rukavice.



### **UPOZORNENIE**

**Riziko pádu dielov po uvoľnení skrutiek!**  
Zranenie padajúcimi dielmi.  
▶ Zaistite komponent proti pádu.



### **POZOR!**

**Riziko pádu dielov po uvoľnení skrutiek!**  
Poškodenie iných častí spotrebiča alebo domácnosti zákazníka, napr. podlahy.  
▶ Zaistite komponent proti pádu.

#### Požiadavka:

- ✔ Spotrebič je odpojený od elektrického napájania.
- ✔ Spotrebič je odpojený od zdroja vody.
- ✔ Spotrebič je voľne dostupný.
- ✔ [Pracovná plocha bola odobratá.→373](#)
- ✔ [Zásuvka na prací prostriedok bola odobratá.→374](#)
- ✔ [Panel obloženia bol odobratý.→376](#)
- ✔ [Dvere boli odobraté.→378](#)
- ✔ [Kryt čerpadla bol odobratý.→380](#)
- ✔ Napínací krúžok bol odobratý.
- ✔ Tesnenie dverí vpredu boli uvoľnené.
- ✔ [Osvetlenie bubna \(voliteľné\) je odobraté.→384](#)

### 4.11.1 Odstránenie čelného panela

1. Nadvihnite spotrebič v prednej časti.
2. Odstráňte skrutky v spodnej časti (1).

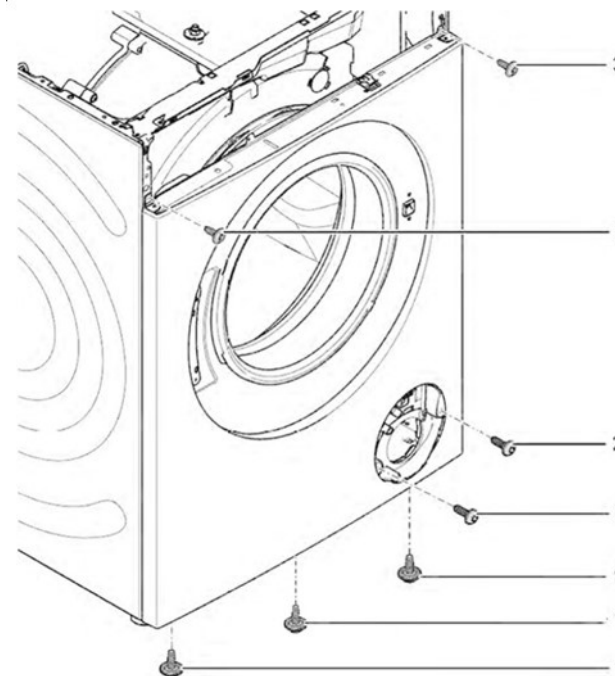

3. Zložte spotrebič na podlahu.

4. Odstráňte skrutky v prednej časti zospodu nahor (2, 3).

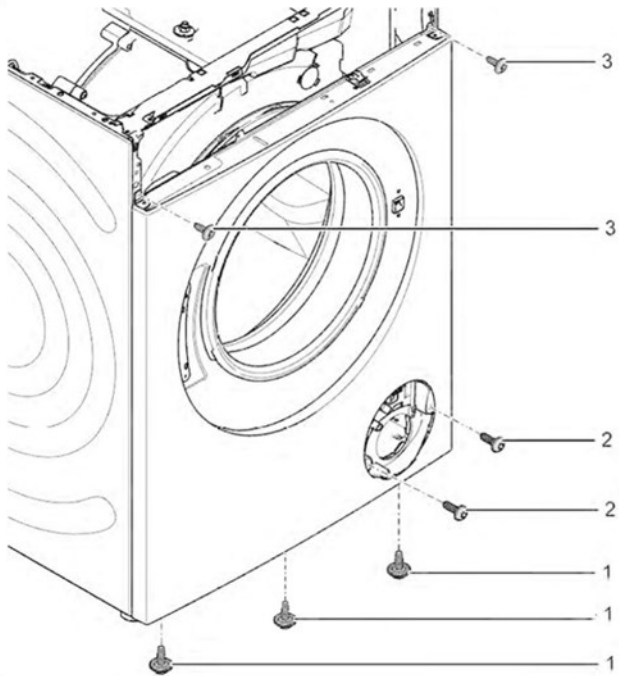

5. Odoberte čelný panel.

### 4.11.2 Montáž čelného panela

- ▶ Pri montáži postupujte v opačnom poradí krokov demontáže.

# Nasveti za popravilo - Pralni stroj

## V zvezi s tem dokumentom ..... 388

1.1	Pomembne informacije .....	388
1.1.1	Namen .....	388
1.2	Razlaga simbolov .....	388
1.2.1	Stopnje nevarnosti .....	388
1.2.2	Simboli za nevarnost .....	388
1.2.3	Struktura opozoril .....	389
1.2.4	Splošni simboli .....	389

## Varnost..... 390

2.1	Splošna varnostna navodila .....	390
2.1.1	Vsi gospodinjski aparati .....	390

## Orodja in pripomočki..... 391

## Popravilo ..... 392

4.1	Zamenjava delovne površine .....	392
4.1.1	Odstranjevanje delovne površine .....	392
4.1.2	Namestitev delovne površine .....	392
4.2	Zamenjava predalčka za detergent .....	393
4.2.1	Odstranjevanje predalčka za detergent .....	393
4.2.2	Namestitev predalčka za detergent .....	393
4.3	Zamenjava ročaja predalčka za detergent .....	394
4.3.1	Odstranjevanje ročaja predalčka za detergent .....	394
4.3.2	Namestitev ročaja predalčka za detergent .....	394
4.4	Zamenjava plošče za vence .....	395
4.4.1	Odstranjevanje plošče za vence .....	395
4.4.2	Namestitev plošče za vence .....	396
4.5	Zamenjava vrat .....	397
4.5.1	Odstranjevanje vrat .....	397
4.5.2	Namestitev vrat .....	397
4.6	Zamenjava komponent vrat .....	398
4.6.1	Odstranjevanje komponent vrat .....	398
4.6.2	Namestitev komponent vrat .....	398
4.7	Zamenjava pokrova črpalke .....	399
4.7.1	Odstranjevanje pokrova črpalke .....	399
4.7.2	Namestitev pokrova črpalke .....	399

4.8	Zamenjava tesnila vrat .....	400
4.8.1	Odstranjevanje tesnila vrat .....	400
4.8.2	Namestitev tesnila vrat .....	400
4.9	Zamenjava varovala vrat .....	401
4.9.1	Odstranjevanje varovala vrat .....	401
4.9.2	Namestitev varovala vrat .....	402
4.10	Zamenjava luči bobna .....	403
4.10.1	Odstranjevanje luči bobna .....	403
4.10.2	Namestitev luči bobna .....	403
4.11	Zamenjava sprednje plošče .....	404
4.11.1	Odstranjevanje sprednje plošče .....	404
4.11.2	Namestitev sprednje plošče .....	405

# **i** V zvezi s tem dokumentom

## 1.1 Pomembne informacije

### 1.1.1 Namen

Ti namigi za popravila uporabnika podpirajo pri lastnoročnem popravilu aparatov skladno z veljavno direktivo glede okoljsko primerne zasnove (od marca 2021).

Vsebujejo informacije o tem, kako zamenjati določene rezervne dele, vključno z opozorili in tveganji.

Če imate kakšna vprašanja, se obrnite na našo servisno službo. Za škodo bomo odgovorni le, če ste namige za popravila upoštevali pravilno.

## 1.2 Razlaga simbolov

### 1.2.1 Stopnje nevarnosti

Stopnje opozoril so sestavljene iz simbola in signalne besede. Signalna beseda označuje stopnjo nevarnosti.





Stopnja opozorila	Pomen
 <b>NEVARNOST</b>	Neupoštevanje opozorilnega sporočila bo povzročilo smrt ali hude poškodbe.
 <b>OPOZORILO</b>	Neupoštevanje opozorilnega sporočila lahko povzroči smrt ali hude poškodbe.
 <b>PREVIDNO</b>	Neupoštevanje opozorilnega sporočila lahko povzroči manjše poškodbe.
<b>POZOR!</b>	Neupoštevanje opozorilnega sporočila lahko povzroči škodo na lastnini.

*Preglednica 1: Stopnje nevarnosti*



### 1.2.2 Simboli za nevarnost

Simboli za nevarnost so simbolni prikazi, ki podajajo informacije o vrsti nevarnosti.

V tem dokumentu so uporabljeni naslednji simboli za nevarnost:

Simbol za nevarnost	Pomen
	Splošno opozorilno sporočilo
	Nevarnost zaradi električne napetosti
	Nevarnost eksplozije
	Nevarnost ureznin
	Nevarnost zmečkanin

## **i** V zvezi s tem dokumentom

Simbol za nevarnost	Pomen
	Nevarnost zaradi vročih površin
	Nevarnost zaradi močnega magnetnega polja
	Nevarnost zaradi neionizirajočega sevanja

Preglednica 2: Simboli za nevarnost

### 1.2.3 Struktura opozoril

Opozorila v tem dokumentu imajo standardiziran videz in standardizirano strukturo.



	<div style="background-color: red; color: white; padding: 2px; display: inline-block;"><b>NEVARNOST</b></div> <p><b>Vrsta in vir nevarnosti!</b> Morebitne posledice ob neupoštevanju nevarnosti/opozorila.</p> <ul style="list-style-type: none"> <li>▶ Ukrepi in prepovedi za preprečevanje nevarnosti.</li> </ul>
--	--





V naslednjem primeru je prikazano opozorilo, ki opozarja pred električnim udarom zaradi delov pod napetostjo. Naveden je ukrep za preprečevanje nevarnosti.

	<div style="background-color: red; color: white; padding: 2px; display: inline-block;"><b>NEVARNOST</b></div> <p><b>Nevarnost električnega udara zaradi delov pod napetostjo!</b> Smrt zaradi električnega udara</p> <ul style="list-style-type: none"> <li>▶ Izključite aparate iz električnega omrežja vsaj 60 sekund pred začetkom popravil.</li> </ul>
---	--

### 1.2.4 Splošni simboli

V tem dokumentu so uporabljeni naslednji splošni simboli:

Splošni simbol	Pomen
	Identifikacija posebnega nasveta (besedilo in/ali slika)
	Identifikacija preprostega nasveta (samo besedilo)
	Identifikacija povezave na video vadnico

Splošni simbol	Pomen
	Identifikacija potrebnih orodij
	Identifikacija potrebnih predpogojev
	Identifikacija pogoja (če ..., potem ...)
	Identifikacija rezultata
Začetek	Identifikacija tipke ali gumba
[00123456]	Identifikacija številke dela
Stanje	Identifikacija prikazanega besedila/okna (na zaslonu aparata)

Preglednica 3: Splošni simboli

## 2.1 Splošna varnostna navodila

### 2.1.1 Vsi gospodinjski aparati

#### **Nevarnost električnega udara zaradi delov pod napetostjo!**

- Napake zaradi popravil električnih komponent lahko povzročijo električni udar!
- Aparat izključite iz električnega omrežja vsaj 60 sekund pred začetkom del.
- Po popravilu je treba izvesti preizkus varnosti v skladu z VDE 0701 ali predpisi, ki veljajo za posamezno državo.

#### **Nevarnost poškodb zaradi ostrih robov!**

- Uporabljajte zaščitne rokavice.

#### **Nevarnost zmečkanin med popravili, vzdrževanjem, odpravljanjem težav ali servisom zaradi težkih in premikajočih se komponent**

- Uporabljajte zaščitne čevlje.
- Težke komponente zavarujte pred padanjem.
- Delov telesa ne vstavljajte v premikajoče se komponente.







#### **Tveganje za varnost/delovanje aparata!**

- Uporabljajte le originalne nadomestne dele.

#### **Tveganje poškodb elektrostatično občutljivih komponent (ESD)!**

- Ne dotikajte se modulov, vključno s povezavami in potmi vodnika.

## Orodja in pripomočki

Oznaka	Podrobnosti	Slike
Pomožno orodje [15000155]	Orodje za rahljanje plastičnih delov	
Izvijač Torx T20 z izvrtino [00340764]	100 mm, za vijake z varnostnim zatičem	
Momentni ključ [15000441]	Momentni ključ 20–100 Nm	
Ploščati zvijač [00340854]	Steblo 3,5 mm x 0,6 mm x 100 mm, zaščitna izolacija 1000 V AC	
Ploščati zvijač [00340855]	Steblo 5,5 mm x 1,0 mm x 125 mm, zaščitna izolacija 1000 V AC	
Igličaste klešče, zakrivljene [00341269]	Dolžina 200 mm	
Klešče za bočno rezanje [00342182]	Dolžina: 200 mm	



Oznaka	Podrobnosti	Slike
Kombinirani ključ [00340811]	Velikost ključa 10°mm, M6	
Combination wrench [00340814]	Velikost ključa 13°mm, M8	
Kombinirani ključ [00340817]	Velikost ključa 17 mm, M10	
Kombinirani ključ [15000459]	Velikost ključa 16°mm, M10	

## 4.1 Zamenjava delovne površine

### Posebna orodja:

-  Del Torx TX20 z odprtino Dolžina 152 mm, uporabna dolžina [00341272]  
124 mm, 1/4" šestrobi pogon  
(6,35 mm), za vijake z varnostnim za-  
tičem

### Zahteva:

-  Aparat je odklopljen iz omrežne napetosti.
-  Aparat je odklopljen iz vira vode.

### 4.1.1 Odstranjevanje delovne površine

- ▶ 1. Odstranite vijake (1).
- ▶ 2. Potisnite delovno površino proti zadnjemu delu aparata (2).
- ▶ 3. Premaknite delovno površino navzgor (3), da jo odstranite.

### 4.1.2 Namestitev delovne površine



Upoštevajte namestitev kabla. Kabel se lahko zatakne.

- ▶ Namestite v obratnem vrstnem redu.

## 4.2 Zamenjava predalčka za detergent

### Zahteva:

- ✓ Aparat je odklopljen iz omrežne napetosti.
- ✓ Aparat je odklopljen iz vira vode.

### 4.2.1 Odstranjevanje predalčka za detergent

1. Izvlecite predalček za detergent.
2. 1. Vstavek (1) potisnite navzdol.  
2. Odstranite predalček za detergent (2).

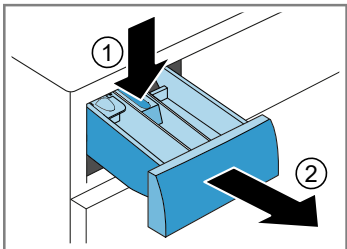

### 4.2.2 Namestitev predalčka za detergent

- ▶ Namestite v obratnem vrstnem redu.

## 4.3 Zamenjava ročaja predalčka za detergent

### Zahteva:

- ✓ Aparat je odklopljen iz omrežne napetosti.
- ✓ Aparat je odklopljen iz vira vode.
- ✓ [Predalček za detergent je bil odstranjen.→393](#)

### 4.3.1 Odstranjevanje ročaja predalčka za detergent

1. Sprostite držalne elemente.

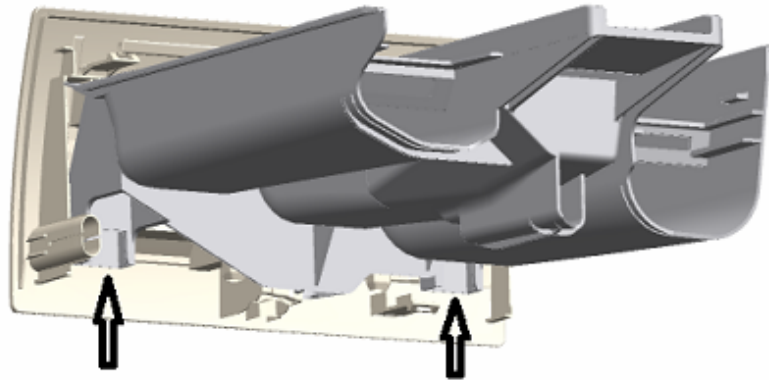

2. Odstranite ročaj predalčka za detergent.

### 4.3.2 Namestitev ročaja predalčka za detergent

- ▶ Namestite v obratnem vrstnem redu.

## 4.4 Zamenjava plošče za vence

Kot proizvajalec moramo potrošnikom zagotoviti nadomestno ploščo za vence vklj. z navodili za uporabo v skladu z direktivo (EU) 2019/2023. Vendar želimo izpostaviti, da je po zamenjavi plošče za vence potreben preizkus elektrotehnične varnosti s strani kvalificiranega električarja, preden začnete z uporabo naprave. Ta oseba mora biti preverljivo kvalificirana v skladu z zakoni, predpisi in standardi, ki veljajo za posamezno državo.

	<b>⚠ NEVARNOST</b>
	<p><b>Nevarnost električnega udara zaradi delov pod napetostjo!</b> Življenjska nevarnost zaradi električnega udara v primeru nepravilnega popravila</p> <ul style="list-style-type: none"> <li>▶ Električne dele mora popraviti kvalificiran električar.</li> <li>▶ Po popravilu je treba izvesti preizkus varnosti v skladu z VDE 0701 ali predpisi, ki veljajo za posamezno državo.</li> </ul>

	<b>⚠ OPOZORILO</b>
	<p><b>Zdrs nagnjenih aparatov!</b> Zlomi kosti/zmečkanine</p> <ul style="list-style-type: none"> <li>▶ Aparate zaščitite pred zdrsavanjem.</li> </ul>

	<b>⚠ PREVIDNO</b>
	<p><b>Ostri robovi ohišja!</b> Ureznine</p> <ul style="list-style-type: none"> <li>▶ Uporabljajte zaščitne rokavice.</li> </ul>

	<b>⚠ PREVIDNO</b>
	<p><b>Nevarnost padajočih delov zaradi zrahljanih vijakov!</b> Poškodbe zaradi padajočih delov.</p> <ul style="list-style-type: none"> <li>▶ Komponento zaščitite pred padcem.</li> </ul>

	<b>POZOR!</b>
	<p><b>Nevarnost padajočih delov zaradi zrahljanih vijakov!</b> Škoda na drugih delih aparata ali pri uporabniku doma, npr. na tleh.</p> <ul style="list-style-type: none"> <li>▶ Komponento zaščitite pred padcem.</li> </ul>

### Zahteva:

- ✓ Aparat je odklopljen iz omrežne napetosti.
- ✓ Aparat je odklopljen iz vira vode.

✓ [Delovna površina je bila odstranjena.→392](#)

✓ [Predalček za detergent je bil odstranjen.→393](#)

### 4.4.1 Odstranjevanje plošče za vence

1. Odstranite vijake (1).
2. Sprostite držalne elemente (2, 3).

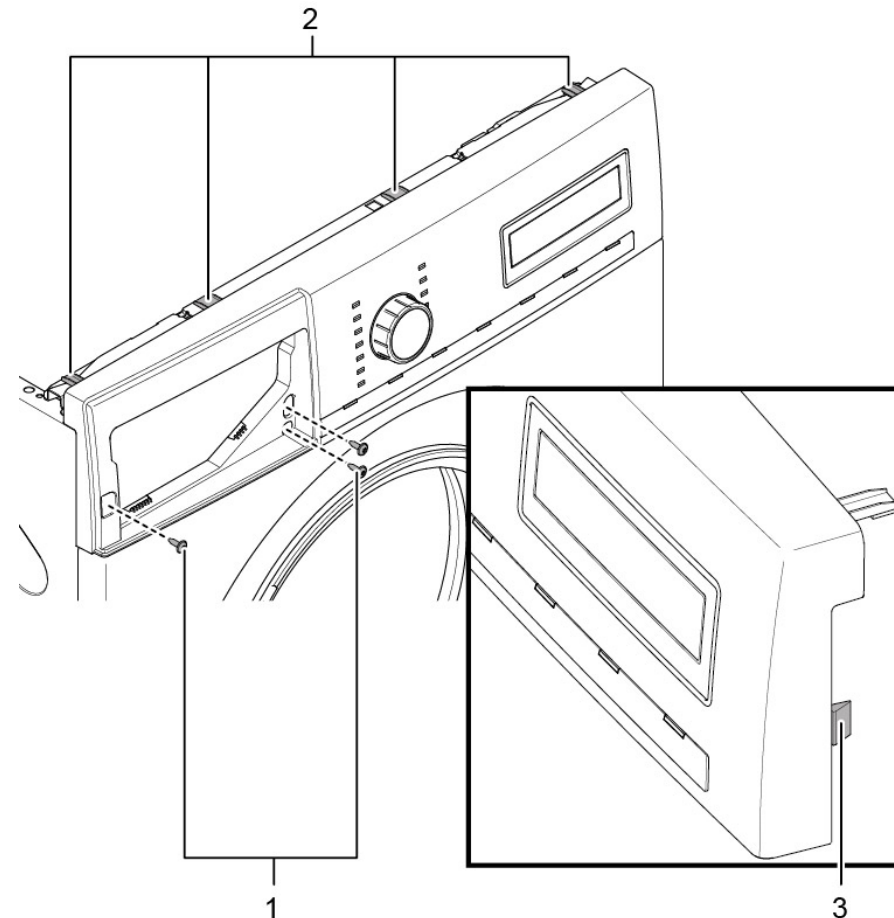

2. Sprostite vtični priključek krmilne enote.
3. Odstranite ploščo za vence.

## 4.4.2 Namestitev plošče za vence



Upoštevajte namestitev kabla. Kabel se lahko zatakne.

- ▶ Namestite v obratnem vrstnem redu.

## 4.5 Zamenjava vrat



### ⚠️ PREVIDNO

#### Odprite območje tečaja!

Zmečkanine/zagorzitev prstov

- ▶ Ne segajte v območje tečajev.
- ▶ Uporabljajte zaščitne rokavice.



### ⚠️ PREVIDNO

#### Nevarnost padajočih delov zaradi zrahljanih vijakov!

Poškodbe zaradi padajočih delov.

- ▶ Komponento zaščitite pred padcem.



### ⚠️ POZOR!

#### Nevarnost padajočih delov zaradi zrahljanih vijakov!

Škoda na drugih delih aparata ali pri uporabniku doma, npr. na tleh.

- ▶ Komponento zaščitite pred padcem.

#### Zahteva:

- ✔ Aparat je odklopljen iz omrežne napetosti.
- ✔ Aparat je odklopljen iz vira vode.
- ✔ Vrata so odprta.

### 4.5.1 Odstranjevanje vrat

1. Odstranite vijake (1).

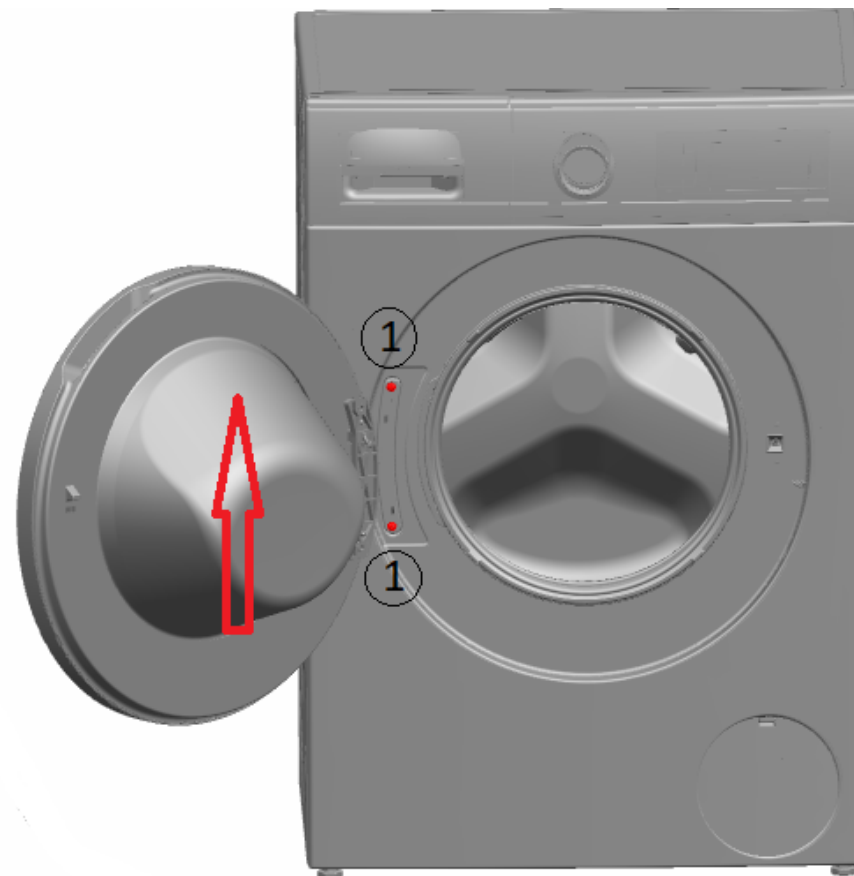



2. Odstranite vrata v smeri navzgor.

### 4.5.2 Namestitev vrat

- ▶ Namestite v obratnem vrstnem redu.

## 4.6 Zamenjava komponent vrat

	<b>⚠ OPOZORILO</b>
	<b>Težke in premikajoče se komponente!</b> Nevarnost zmečkanin med popravili, vzdrževanjem, odpravljanjem težav ali servisom <ul style="list-style-type: none"><li>▶ Uporabljajte zaščitne čevlje.</li><li>▶ Težke komponente zavarujte pred padanjem.</li><li>▶ Delov telesa ne vstavljajte v premikajoče se komponente.</li></ul>

	<b>⚠ PREVIDNO</b>
	<b>Odprite območje tečaja!</b> Zmečkanine/zagozditev prstov <ul style="list-style-type: none"><li>▶ Ne segajte v območje tečajev.</li><li>▶ Uporabljajte zaščitne rokavice.</li></ul>

### Zahteva:

- ✓ Aparat je odklopljen iz omrežne napetosti.
- ✓ Aparat je odklopljen iz vira vode.
- ✓ [Vrata so bila odstranjena.→397](#)

### 4.6.1 Odstranjevanje komponent vrat

- ▶ Vrata razstavite od zunanje proti notranji strani.

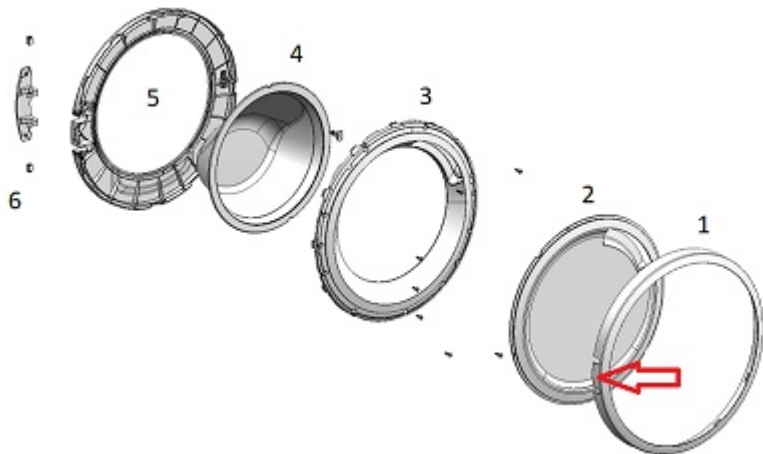

### 4.6.2 Namestitev komponent vrat

- ▶ Namestite v obratnem vrstnem redu.

## 4.7 Zamenjava pokrova črpalke

### Zahteva:

- ✓ Aparat je odklopljen iz omrežne napetosti.
- ✓ Aparat je odklopljen iz vira vode.

### 4.7.1 Odstranjevanje pokrova črpalke

1. Odprite pokrov črpalke.

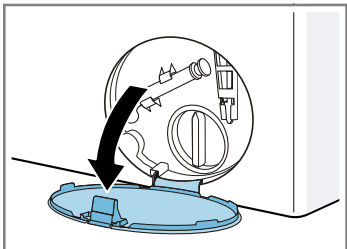

2. Odstranite pokrov črpalke.

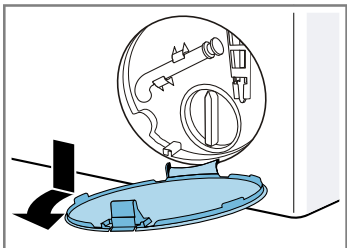



### 4.7.2 Namestitev pokrova črpalke

- ▶ Namestite v obratnem vrstnem redu.

## 4.8 Zamenjava tesnila vrat

	<b>⚠️ PREVIDNO</b> <b>Ostri robovi ohišja!</b> Ureznine ▶ Uporabljajte zaščitne rokavice.
--	--

	<b>⚠️ PREVIDNO</b> <b>Nevarnost padajočih delov zaradi zrahljanih vijakov!</b> Poškodbe zaradi padajočih delov. ▶ Komponento zaščitite pred padcem.
--	--

	<b>⚠️ POZOR!</b> <b>Nevarnost padajočih delov zaradi zrahljanih vijakov!</b> Škoda na drugih delih aparata ali pri uporabniku doma, npr. na tleh. ▶ Komponento zaščitite pred padcem.
--	--

### Zahteva:

- ✔️ Aparat je odklopljen iz omrežne napetosti.
- ✔️ Aparat je odklopljen iz vira vode.
- ✔️ Aparat je prosto dostopen.
- ✔️ [Delovna površina je bila odstranjena.→392](#)
- ✔️ [Predalček za detergent je bil odstranjen.→393](#)
- ✔️ [Plošča za vence je bila odstranjena.→395](#)
- ✔️ [Vrata so bila odstranjena.→397](#)
- ✔️ [Pokrov črpalke je bil odstranjen.→399](#)
- ✔️ [Sprednja plošča je bila odstranjena.→404](#)
- ✔️ [Luč bobna je bila odstranjena \(izbirno\).→403](#)

## 4.8.1 Odstranjevanje tesnila vrat

1. Sprostite vse priključke cevi.

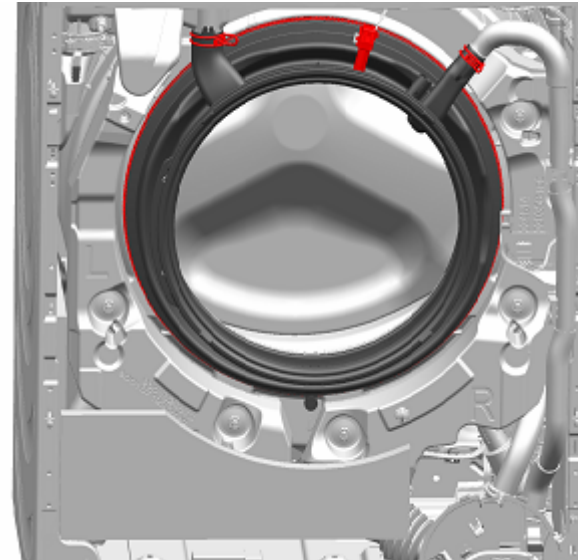

2. Odstranite tesnilo vrat.





## 4.8.2 Namestitev tesnila vrat

	<b>⚠️ OPOZORILO</b> <b>Nevarnost padajočih delov zaradi nepravilne namestitve!</b> Poškodba ali škoda na aparatu. ▶ Zategnite obroč napenjalnika tesnila vrat z zateznim momentom 3,4 Nm.
--	--

- ▶ Namestite v obratnem vrstnem redu.

## 4.9 Zamenjava varovala vrat

Kot proizvajalec moramo potrošnikom zagotoviti nadomestno varovalo vrat vklj. z navodili za uporabo v skladu z direktivo (EU) 2019/2023. Vendar želimo izpostaviti, da je po zamenjavi varovala vrat potreben preizkus elektrotehnične varnosti s strani kvalificiranega električarja, preden začnete z uporabo naprave. Ta oseba mora biti preverljivo kvalificirana v skladu z zakoni, predpisi in standardi, ki veljajo za posamezno državo.

	<b>NEVARNOST</b> <b>Nevarnost električnega udara zaradi delov pod napetostjo!</b> Življenjska nevarnost zaradi električnega udara v primeru nepravilnega popravila <ul style="list-style-type: none"><li>▶ Električne dele mora popraviti kvalificiran električar.</li><li>▶ Po popravilu je treba izvesti preizkus varnosti v skladu z VDE 0701 ali predpisi, ki veljajo za posamezno državo.</li></ul>
	<b>OPOZORILO</b> <b>Zdrs nagnjenih aparatov!</b> Zlomi kosti/zmečkanine <ul style="list-style-type: none"><li>▶ Aparate zaščitite pred zdrsavanjem.</li></ul>
	<b>PREVIDNO</b> <b>Ostri robovi ohišja!</b> Ureznine <ul style="list-style-type: none"><li>▶ Uporabljajte zaščitne rokavice.</li></ul>
	<b>PREVIDNO</b> <b>Nevarnost padajočih delov zaradi zrahljanih vijakov!</b> Poškodbe zaradi padajočih delov. <ul style="list-style-type: none"><li>▶ Komponento zaščitite pred padcem.</li></ul>
	<b>POZOR!</b> <b>Nevarnost padajočih delov zaradi zrahljanih vijakov!</b> Škoda na drugih delih aparata ali pri uporabniku doma, npr. na tleh. <ul style="list-style-type: none"><li>▶ Komponento zaščitite pred padcem.</li></ul>

### Zahteva:

- ✓ Aparat je odklopljen iz omrežne napetosti.
- ✓ Aparat je odklopljen iz vira vode.

- ✓ Aparat je prosto dostopen.
- ✓ [Delovna površina je bila odstranjena.→392](#)
- ✓ [Predalček za detergent je bil odstranjen.→393](#)
- ✓ [Plošča za vence je bila odstranjena.→395](#)
- ✓ [Vrata so bila odstranjena.→397](#)
- ✓ Obroč napenjalnika je bil odstranjen.
- ✓ [Tesnilo vrat je bilo odstranjeno.→400](#)
- ✓ [Pokrov črpalke je bil odstranjen.→399](#)
- ✓ [Sprednja plošča je bila odstranjena.→404](#)

### 4.9.1 Odstranjevanje varovala vrat

1. Odklopite vtič varovala vrat.
2. Sprostite varovalo vrat.



3. Odstranite varovalo vrat.



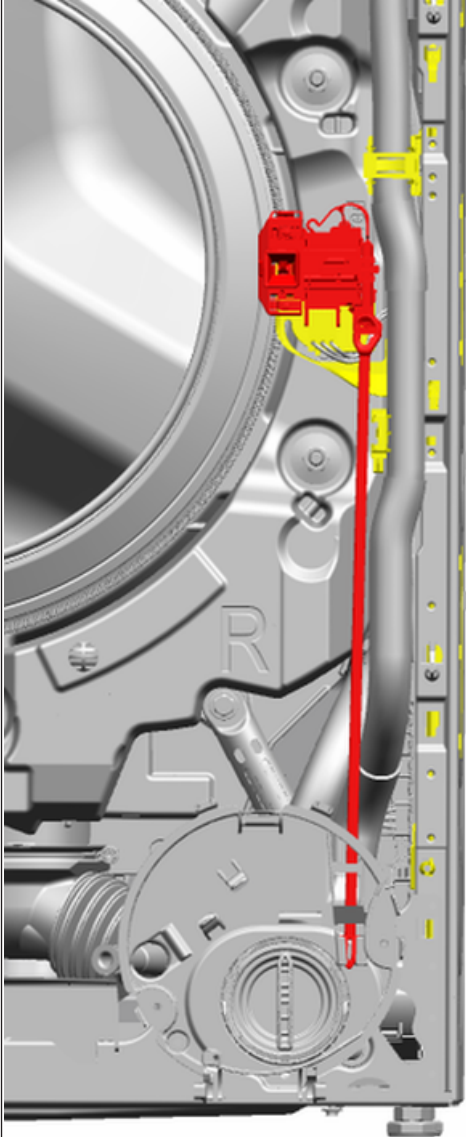

### 4.9.2 Namestitev varovala vrat

Varovalo vrat mora biti v pravilnem položaju, da na aparatu zagotovite delovanje funkcije odpiranja vrat v sili.



- ▶ Namestite v obratnem vrstnem redu.

## 4.10 Zamenjava luči bobna

	<b>⚠️ OPOZORILO</b> <b>Zdrs nagnjenih aparatov!</b> Zlomi kosti/zmečkanine ▶ Aparate zaščitite pred zdrsavanjem.
	<b>⚠️ PREVIDNO</b> <b>Ostri robovi ohišja!</b> Ureznine ▶ Uporabljajte zaščitne rokavice.
	<b>⚠️ PREVIDNO</b> <b>Nevarnost padajočih delov zaradi zrahljanih vijakov!</b> Poškodbe zaradi padajočih delov. ▶ Komponento zaščitite pred padcem.
	<b>⚠️ POZOR!</b> <b>Nevarnost padajočih delov zaradi zrahljanih vijakov!</b> Škoda na drugih delih aparata ali pri uporabniku doma, npr. na tleh. ▶ Komponento zaščitite pred padcem.

### Zahteva:

- ✔️ Aparat je odklopljen iz omrežne napetosti.
- ✔️ Aparat je odklopljen iz vira vode.
- ✔️ Aparat je prosto dostopen.
- ✔️ [Delovna površina je bila odstranjena.→392](#)
- ✔️ [Predalček za detergent je bil odstranjen.→393](#)
- ✔️ [Plošča za vence je bila odstranjena.→395](#)

## 4.10.1 Odstranjevanje luči bobna

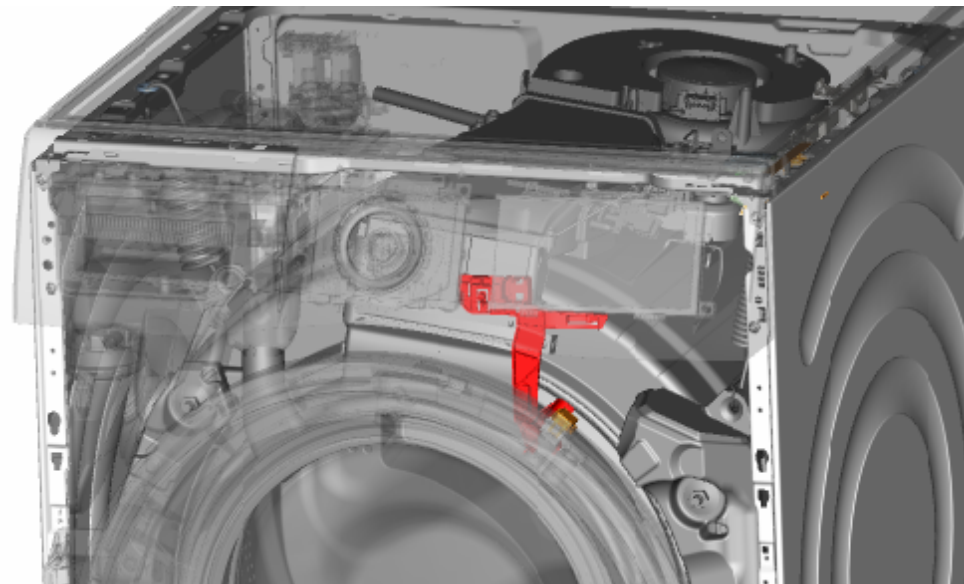

1. Izvlecite držalo luči bobna iz aparata.
2. Odklopite električne priključke.
3. Odstranite luč bobna z držala luči bobna.

## 4.10.2 Namestitev luči bobna

	Upoštevajte namestitev kabla. Kabel se lahko zatakne.
---	---

- ▶ Namestite v obratnem vrstnem redu.

## 4.11 Zamenjava sprednje plošče



### ⚠️ OPOZORILO

#### Zdrs nagnjenih aparatov!

Zlomi kosti/zmečkanine

- ▶ Aparate zaščitite pred zdrsavanjem.



### ⚠️ PREVIDNO

#### Ostri robovi ohišja!

Ureznine

- ▶ Uporabljajte zaščitne rokavice.



### ⚠️ PREVIDNO

#### Nevarnost padajočih delov zaradi zrahljanih vijakov!

Poškodbe zaradi padajočih delov.

- ▶ Komponento zaščitite pred padcem.



### ⚠️ POZOR!

#### Nevarnost padajočih delov zaradi zrahljanih vijakov!

Škoda na drugih delih aparata ali pri uporabniku doma, npr. na tleh.

- ▶ Komponento zaščitite pred padcem.

#### Zahteva:

- ✔ Aparat je odklopljen iz omrežne napetosti.
- ✔ Aparat je odklopljen iz vira vode.
- ✔ Aparat je prosto dostopen.
- ✔ [Delovna površina je bila odstranjena.→392](#)
- ✔ [Predalček za detergent je bil odstranjen.→393](#)
- ✔ [Plošča za vence je bila odstranjena.→395](#)
- ✔ [Vrata so bila odstranjena.→397](#)
- ✔ [Pokrov črpalke je bil odstranjen.→399](#)
- ✔ Obroč napenjalnika je bil odstranjen.
- ✔ Tesnilo vrat je bilo sproščeno na sprednji strani.
- ✔ [Luč bobna je bila odstranjena \(izbirno\).→403](#)

### 4.11.1 Odstranjevanje sprednje plošče

1. Dvignite sprednji del aparata.

2. Odstranite vijake na dnu (1).

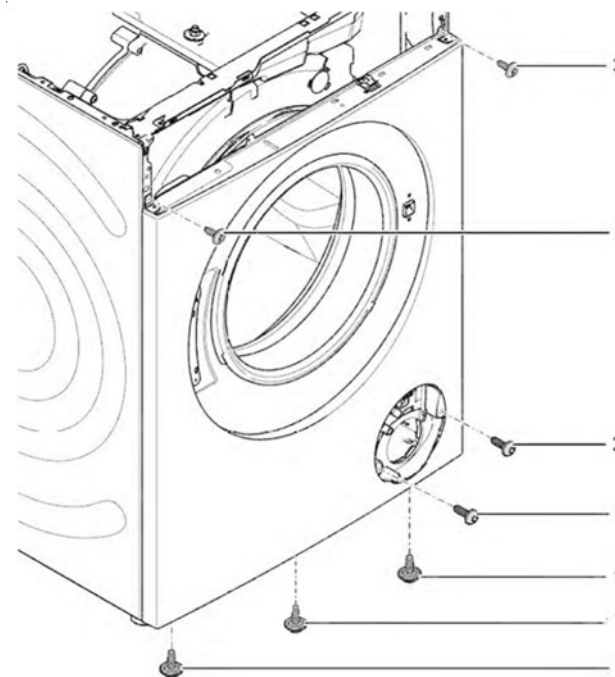

3. Spustite aparat.

## Popravilo

4. Odstranite vijake na sprednji strani, pri čemer začnite od spodaj proti vrhu (2, 3).

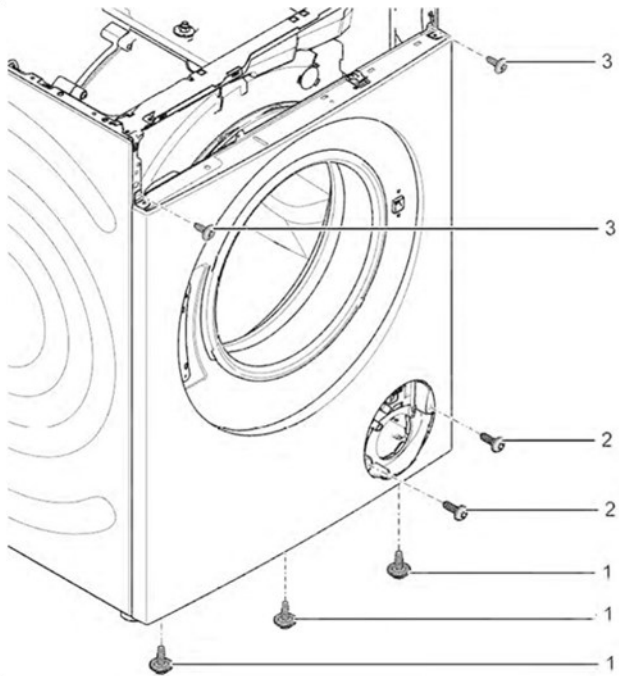

5. Odstranite sprednjo ploščo.

### 4.11.2 Namestitev sprednje plošče

- ▶ Namestite v obratnem vrstnem redu.

# Consejos de reparación - Lavadora

## En relación con este documento ..... 407

1.1	Información importante .....	407
1.1.1	Finalidad .....	407
1.2	Explicación de símbolos generales .....	407
1.2.1	Niveles de peligrosidad .....	407
1.2.2	Símbolos de peligro .....	407
1.2.3	Estructura de las advertencias .....	408
1.2.4	Símbolos generales .....	408

## Seguridad..... 409

2.1	Instrucciones generales de seguridad .....	409
2.1.1	Todos los aparatos electrodomésticos.....	409

## Herramientas y auxiliares ..... 410

## Reparación ..... 411

4.1	Sustituir la tapa superior .....	411
4.1.1	Desmontar la tapa superior.....	411
4.1.2	Montar la tapa superior.....	411
4.2	Sustituir el compartimento para detergente .....	412
4.2.1	Desmontar el compartimento para detergente .....	412
4.2.2	Montar el compartimento para detergente .....	412
4.3	Sustituir el tirador del compartimento para detergente .....	413
4.3.1	Desmontar el tirador del compartimento para detergente.....	413
4.3.2	Montar el tirador del compartimento para detergente.....	413
4.4	Sustituir el panel de control .....	414
4.4.1	Desmontar el panel de control .....	414
4.4.2	Montar el panel de control .....	415
4.5	Sustituir la puerta .....	416
4.5.1	Extraer la puerta .....	416
4.5.2	Montar la puerta.....	416
4.6	Sustituir los componentes de la puerta.....	417
4.6.1	Desmontar los componentes de la puerta.....	417
4.6.2	Montar los componentes de la puerta.....	417
4.7	Sustituir la tapa de la bomba .....	418
4.7.1	Retirar la tapa de la bomba.....	418
4.7.2	Montar la tapa de la bomba .....	418

4.8	Sustituir la junta de la puerta.....	419
4.8.1	Extraer la junta de la puerta .....	419
4.8.2	Montar la junta de la puerta.....	419
4.9	Sustituir el cierre de la puerta .....	420
4.9.1	Extraer el cierre de la puerta .....	420
4.9.2	Montar el cierre de la puerta.....	421
4.10	Sustituir la iluminación del tambor .....	422
4.10.1	Desmontar la iluminación del tambor .....	422
4.10.2	Montar la iluminación del tambor .....	422
4.11	Sustituir el panel frontal.....	423
4.11.1	Extraer el panel frontal.....	423
4.11.2	Montar el panel frontal .....	424

# **i** En relación con este documento

## 1.1 Información importante

### 1.1.1 Finalidad

Estas indicaciones de reparación sirven como ayuda al consumidor para reparar aparatos por su cuenta conforme al reglamento aplicable sobre diseño ecológico (a partir de 03/2021).

Contienen información sobre cómo sustituir repuestos determinados e incluye las advertencias y los riesgos.

En caso de dudas, póngase en contacto con nuestro departamento de atención al cliente. Solo asumiremos la responsabilidad por daños si las indicaciones de reparación se han seguido correctamente.

## 1.2 Explicación de símbolos generales

### 1.2.1 Niveles de peligrosidad

Los niveles de peligro consisten en un símbolo y una palabra de advertencia. La palabra de advertencia identifica la gravedad del peligro.





Nivel de peligro	Significado
 <b>PELIGRO</b>	Si no se tiene en cuenta la advertencia, ocasionará la muerte o lesiones graves.
 <b>ADVERTENCIA</b>	Si no se tiene en cuenta la advertencia, puede ocasionar la muerte o lesiones graves.
 <b>PRECAUCIÓN</b>	Si no se tiene en cuenta la advertencia, puede ocasionar lesiones de carácter leve.
<b>ATENCIÓN</b>	Si no se tiene en cuenta la advertencia, puede ocasionar daños materiales.

Tabla 1: Niveles de peligrosidad

### 1.2.2 Símbolos de peligro

Los símbolos de peligro son una representación simbólica que indica el tipo de peligrosidad.

En este documento se utilizan los siguientes símbolos de peligro:

Símbolo de peligro	Significado
	Advertencia general
	Peligro de lesiones por corriente eléctrica
	Riesgo de explosión
	Peligro de lesiones a causa de cortes

## **i** En relación con este documento





Símbolo de peligro	Significado
	Peligro de lesiones por aplastamiento
	Peligro de lesiones por superficies calientes
	Peligro a causa de campos magnéticos de gran potencia
	Peligro derivado de radiación no ionizante

Tabla 2: Símbolos de peligro

### 1.2.3 Estructura de las advertencias

Las advertencias de este documento tienen una apariencia y una estructura uniformes.

	<p><b>⚠ PELIGRO</b></p> <p><b>¡Tipo y fuente del peligro!</b> Posibles consecuencias de ignorar el peligro / la advertencia.</p> <ul style="list-style-type: none"> <li>▶ Medidas y prohibiciones para prevenir el peligro.</li> </ul>
--	--

El ejemplo siguiente muestra una advertencia de descarga eléctrica a causa de piezas o partes cargadas con tensión. Se menciona la medida para evitar el peligro.

	<p><b>⚠ PELIGRO</b></p> <p><b>¡Riesgo de descarga eléctrica debido a partes con tensión!</b> Muerte por electrocución</p> <ul style="list-style-type: none"> <li>▶ Desconectar el aparato de la red al menos 60 segundos antes de comenzar con la reparación.</li> </ul>
--	--

### 1.2.4 Símbolos generales

En este documento se utilizan los siguientes símbolos generales:

Símbolo general	Significado
	Identificación de una indicación especial (texto y/o gráfico)







Símbolo general	Significado
	Identificación de un consejo simple (solo texto)
	Identificación de un enlace a un video tutorial
	Identificación de una herramienta requerida
	Identificación de una condición previa (prerrequisito)
	Identificación de una condición (si ..., entonces ...)
	Identificación de un resultado
Iniciar	Identificación de una tecla o botón
[00123456]	Identificación de un número de material
Estado	Identificación del texto / ventana mostrado (en el display del aparato)

Tabla 3: Símbolos generales

## 2.1 Instrucciones generales de seguridad

### 2.1.1 Todos los aparatos electrodomésticos

#### ¡Riesgo de descarga eléctrica debido a piezas con tensión!

- ¡Los errores en las reparaciones que incluyan componentes eléctricos pueden provocar una descarga eléctrica!
- Desconectar el aparato de la red durante al menos 60 segundos antes de comenzar con el trabajo.
- Después de la reparación, encargar una prueba de seguridad conforme a VDE 0701 o los reglamentos específicos del país.

#### ¡Riesgo de lesiones debido a bordes afilados!

- Usar guantes de protección.

#### Riesgo de aplastamiento durante la reparación, mantenimiento, resolución de problemas y servicio debido a componentes pesados y móviles

- Usar calzado de seguridad.
- Asegure los componentes pesados para que no se caigan.
- No pegue partes del cuerpo en componentes móviles.





#### ¡Riesgo para la seguridad/el funcionamiento del aparato!





- Utilizar únicamente los repuestos originales.

#### ¡Riesgo de daños de los componentes sensibles a cargas electrostáticas (ESD)!

- No tocar los módulos, incluidas las conexiones y las pistas conductoras.

## Herramientas y auxiliares

Designación	Detalles	Imágenes
Herramienta auxiliar [15000155]	Herramienta para aflojar piezas de plástico	
Destornillador Torx T20 con orificio de centrado [00340764]	100 mm, para tornillos de seguridad	
Llave dinamométrica [15000441]	Llave dinamométrica 20 - 100 Nm	
Destornillador plano [00340854]	Punta 3,5 mm x 0,6 mm x 100 mm, Protección aislamiento 1000 V AC	
Destornillador plano [00340855]	Punta 5,5 mm x 1,0 mm x 125 mm, Protección aislamiento 1000 V AC	
Alicates de punta fina curvada [00341269]	Longitud 200 mm	



Designación	Detalles	Imágenes
Alicates corte diagonal [00342182]	Longitud: 200 mm	
Llave combinada [00340811]	Medida llave 10°mm, M6	
Combination wrench [00340814]	Medida llave 13°mm, M8	
Llave combinada [00340817]	Medida llave 17 mm, M10	
Llave combinada [15000459]	Medida llave 16°mm, M10	

## 4.1 Sustituir la tapa superior

### Herramientas necesarias:

-  Punta Torx TX20 con agujero Longitud 152 mm, longitud útil 124 mm, 1/4" longitud hexágono (6.35 mm), para tornillos con pin de seguridad [00341272]

### Requisito:

-  El aparato está desconectado del suministro eléctrico.
-  El aparato está desconectado del suministro de agua.

### 4.1.1 Desmontar la tapa superior

- ▶ 1. Retirar los tornillos (1).
- ▶ 2. Empujar la tapa superior hacia la parte posterior del aparato (2).
- ▶ 3. Tirar de la tapa superior hacia arriba (3) para retirarla.

### 4.1.2 Montar la tapa superior



Observar el montaje del cable. El cable podría estar atrapado.

- ▶ Montar en orden inverso.

## 4.2 Sustituir el compartimento para detergente

### Requisito:

- ✓ El aparato está desconectado del suministro eléctrico.
- ✓ El aparato está desconectado del suministro de agua.

### 4.2.1 Desmontar el compartimento para detergente

1. Extraer el compartimento para detergente.
2. 1. Presione hacia abajo en el inserto (1).  
2. Desmontar el compartimento para detergente (2).

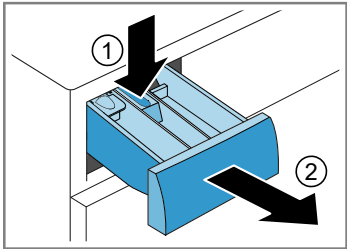

### 4.2.2 Montar el compartimento para detergente

- ▶ Montar en orden inverso.

## 4.3 Sustituir el tirador del compartimento para detergente

### Requisito:

- ✓ El aparato está desconectado del suministro eléctrico.
- ✓ El aparato está desconectado del suministro de agua.
- ✓ [Se ha retirado el compartimento para detergente.→412](#)

### 4.3.1 Desmontar el tirador del compartimento para detergente

1. Desenganchar los elementos de sujeción.

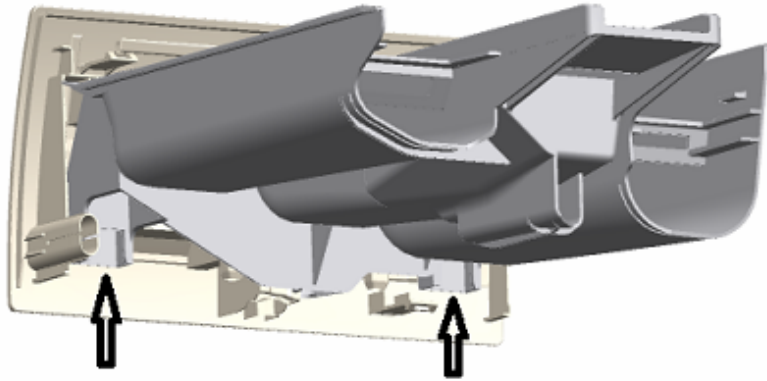

2. Desmontar el tirador del compartimento para detergente.

### 4.3.2 Montar el tirador del compartimento para detergente

- ▶ Montar en orden inverso.

## 4.4 Sustituir el panel de control

Como fabricante, estamos obligados a proporcionar a los clientes la pieza de repuesto panel de mandos, incluidas las instrucciones de reparación conforme al Reglamento (UE) 2019/2023. No obstante, nos gustaría resaltar que después de reemplazar el panel de mandos, es necesario que un electricista cualificado realice una prueba de seguridad electrotécnica antes de poner el aparato en funcionamiento. Esta persona debe estar cualificada (de forma verificable) de acuerdo con las leyes, reglamentos y normas específicos del país.

	<b>⚠ PELIGRO</b>
	<p><b>¡Riesgo de descarga eléctrica debido a piezas con tensión!</b>                  Peligro mortal por descarga eléctrica en caso de reparación inadecuada</p> <ul style="list-style-type: none"> <li>▶ Las piezas eléctricas deberían ser reparadas por electricistas cualificados.</li> <li>▶ Después de la reparación, encargar una prueba de seguridad conforme a VDE 0701 o los reglamentos específicos del país.</li> </ul>

	<b>⚠ ADVERTENCIA</b>
	<p><b>¡Deslizamiento de aparatos inclinados!</b>                  Fracturas óseas / lesiones por aplastamiento</p> <ul style="list-style-type: none"> <li>▶ Asegurar los electrodomésticos contra deslizamientos.</li> </ul>

	<b>⚠ PRECAUCIÓN</b>
	<p><b>¡Bordes de la carcasa cortantes!</b>                  Peligro de cortes</p> <ul style="list-style-type: none"> <li>▶ Usar guantes de seguridad.</li> </ul>

	<b>⚠ PRECAUCIÓN</b>
	<p><b>¡Riesgo de que se caigan piezas debido a los tornillos aflojados!</b>                  Peligro de lesiones debido a piezas que caigan.</p> <ul style="list-style-type: none"> <li>▶ Asegure el componente para que no se caiga.</li> </ul>

	<b>⚠ ATENCION</b>
	<p><b>¡Riesgo de que se caigan piezas debido a los tornillos aflojados!</b>                  Daños en otras partes del aparato o en el domicilio del consumidor, p. ej., en la parte inferior.</p> <ul style="list-style-type: none"> <li>▶ Asegure el componente para que no se caiga.</li> </ul>

### Requisito:

- ✓ El aparato está desconectado del suministro eléctrico.
- ✓ El aparato está desconectado del suministro de agua.
- ✓ [Se ha retirado la tapa superior.→411](#)
- ✓ [Se ha retirado el compartimento para detergente.→412](#)

### 4.4.1 Desmontar el panel de control

1. Retirar los tornillos (1).
2. Desenganchar los elementos de sujeción (2, 3).

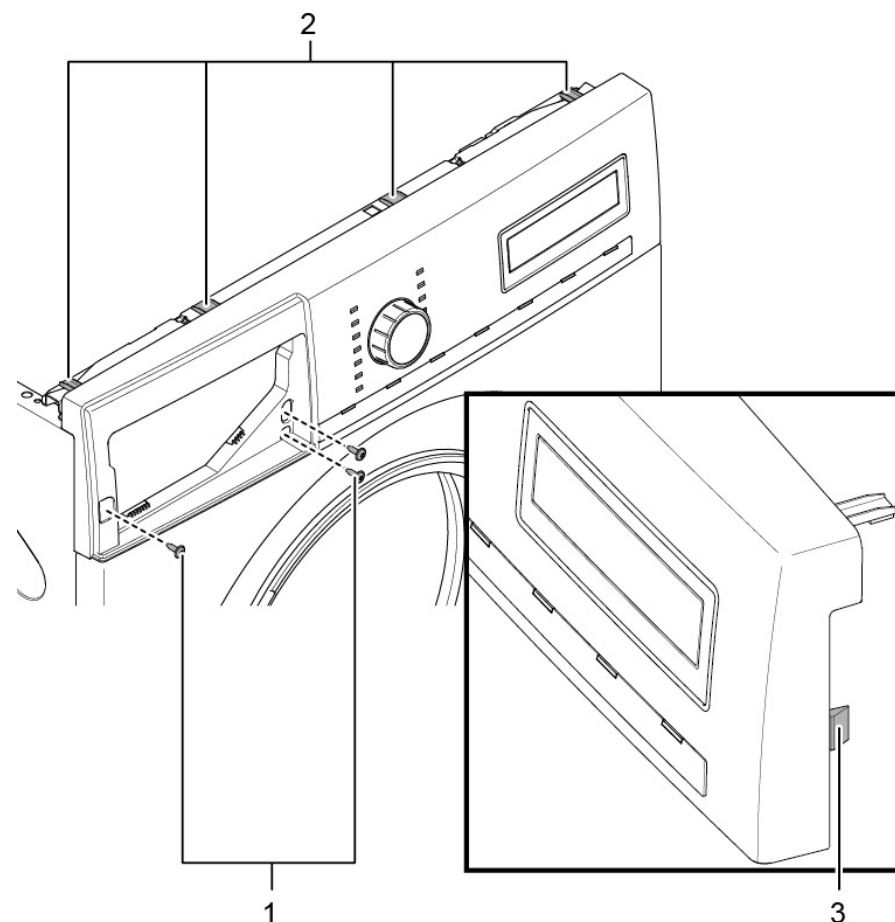

2. Abrir el contacto de enchufe de la unidad de control.
3. Desmontar el panel de control.

### 4.4.2 Montar el panel de control



Observar el montaje del cable. El cable podría estar atrapado.

- ▶ Montar en orden inverso.

## 4.5 Sustituir la puerta



### ⚠️ PRECAUCIÓN

#### ¡Zona de bisagra abierta!

- Aplastamiento / atrapamiento de dedos
- ▶ No acceder a la zona de la bisagra.
  - ▶ Usar guantes de seguridad.



### ⚠️ PRECAUCIÓN

#### ¡Riesgo de que se caigan piezas debido a los tornillos aflojados!

- Peligro de lesiones debido a piezas que caigan.
- ▶ Asegure el componente para que no se caiga.



### ⚠️ ATENCION

#### ¡Riesgo de que se caigan piezas debido a los tornillos aflojados!

- Daños en otras partes del aparato o en el domicilio del consumidor, p. ej., en la parte inferior.
- ▶ Asegure el componente para que no se caiga.

#### Requisito:

- ✔ El aparato está desconectado del suministro eléctrico.
- ✔ El aparato está desconectado del suministro de agua.
- ✔ La puerta está abierta.

### 4.5.1 Extraer la puerta

1. Retirar los tornillos (1).

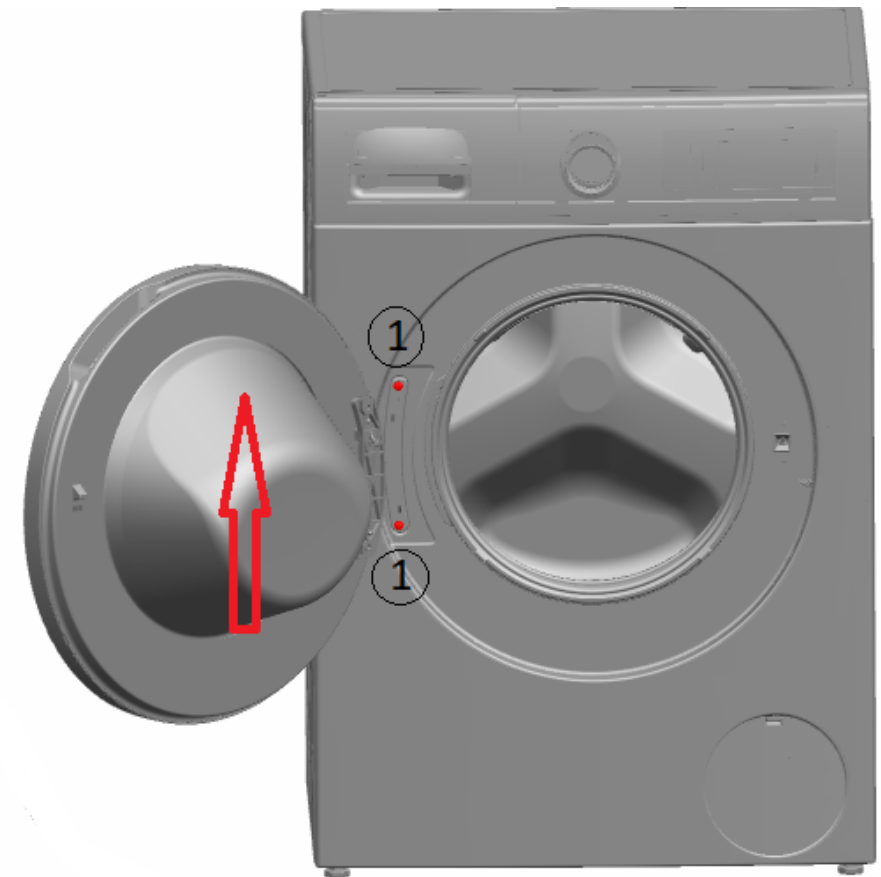



2. Extraer la puerta hacia arriba.

### 4.5.2 Montar la puerta

- ▶ Montar en orden inverso.

## 4.6 Sustituir los componentes de la puerta

	<b>⚠ ADVERTENCIA</b>
	<b>¡Componentes pesados y móviles!</b> Riesgo de aplastamiento durante la reparación, mantenimiento, solución de problemas y servicio <ul style="list-style-type: none"><li>▶ Usar calzado de seguridad.</li><li>▶ Asegure los componentes pesados para que no se caigan.</li><li>▶ No pegue partes del cuerpo en componentes móviles.</li></ul>

	<b>⚠ PRECAUCIÓN</b>
	<b>¡Zona de bisagra abierta!</b> Aplastamiento / atrapamiento de dedos <ul style="list-style-type: none"><li>▶ No acceder a la zona de la bisagra.</li><li>▶ Usar guantes de seguridad.</li></ul>

### Requisito:

- ✓ El aparato está desconectado del suministro eléctrico.
- ✓ El aparato está desconectado del suministro de agua.
- ✓ [Se ha retirado la puerta.→416](#)

### 4.6.1 Desmontar los componentes de la puerta

- ▶ Desmontar la puerta desde fuera hacia dentro.

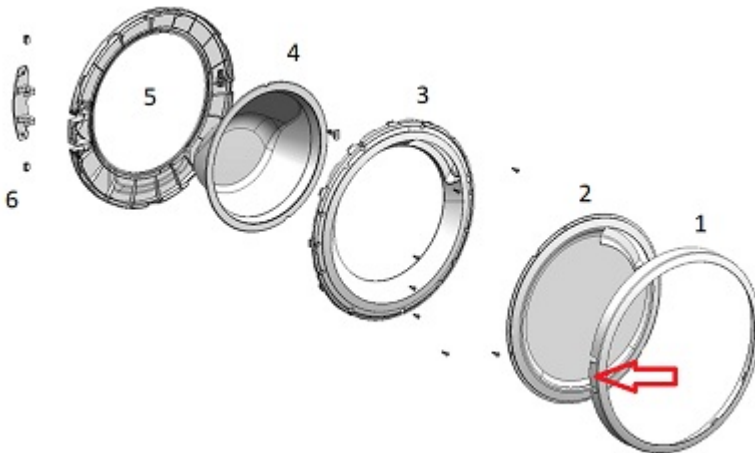

### 4.6.2 Montar los componentes de la puerta

- ▶ Montar en orden inverso.

## 4.7 Sustituir la tapa de la bomba

### Requisito:

- ✓ El aparato está desconectado del suministro eléctrico.
- ✓ El aparato está desconectado del suministro de agua.

### 4.7.1 Retirar la tapa de la bomba

1. Abrir la tapa de la bomba.

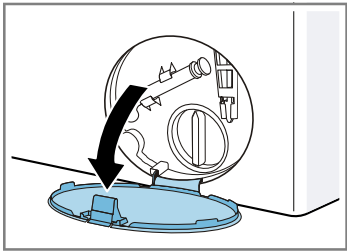

2. Retirar la tapa de la bomba.

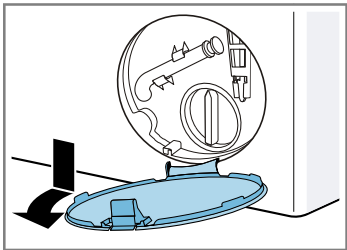



### 4.7.2 Montar la tapa de la bomba

- ▶ Montar en orden inverso.

## 4.8 Sustituir la junta de la puerta

	<b>⚠ PRECAUCIÓN</b> <b>¡Bordes de la carcasa cortantes!</b> Peligro de cortes ▶ Usar guantes de seguridad.
--	---

	<b>⚠ PRECAUCIÓN</b> <b>¡Riesgo de que se caigan piezas debido a los tornillos aflojados!</b> Peligro de lesiones debido a piezas que caigan. ▶ Asegure el componente para que no se caiga.
--	---

	<b>⚠ ATENCION</b> <b>¡Riesgo de que se caigan piezas debido a los tornillos aflojados!</b> Daños en otras partes del aparato o en el domicilio del consumidor, p. ej., en la parte inferior. ▶ Asegure el componente para que no se caiga.
--	---

### Requisito:

- ✔ El aparato está desconectado del suministro eléctrico.
- ✔ El aparato está desconectado del suministro de agua.
- ✔ Puede accederse libremente al aparato.
- ✔ [Se ha retirado la tapa superior.→411](#)
- ✔ [Se ha retirado el compartimento para detergente.→412](#)
- ✔ [Se ha retirado el panel de mandos.→414](#)
- ✔ [Se ha retirado la puerta.→416](#)
- ✔ [Se ha retirado la tapa de la bomba.→418](#)
- ✔ [Se ha retirado el panel frontal.→423](#)
- ✔ [Se ha retirado la iluminación del tambor \(opcional\).→422](#)

### 4.8.1 Extraer la junta de la puerta

1. Aflojar todas las conexiones de manguera.

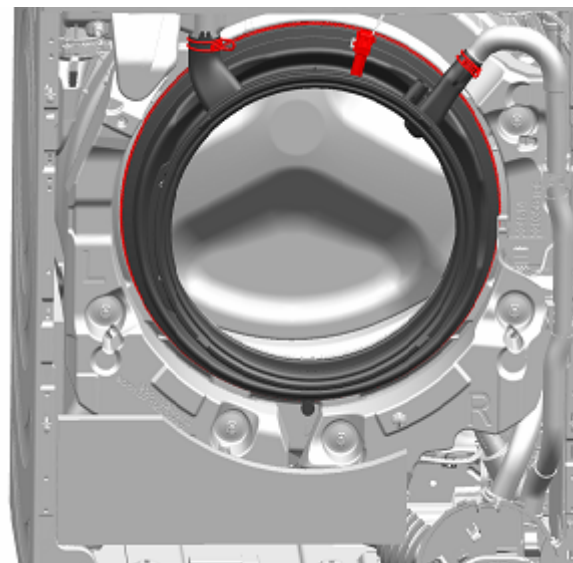

2. Retirar la junta de la puerta.

### 4.8.2 Montar la junta de la puerta

	<b>⚠ ADVERTENCIA</b> <b>¡Riesgo de que se caigan piezas debido a una instalación incorrecta!</b> Lesiones o daños en el aparato. ▶ Apretar el anillo de tensión de la junta de la puerta con 3,4 Nm.
--	---

- ▶ Montar en orden inverso.

## 4.9 Sustituir el cierre de la puerta

Como fabricante, estamos obligados a proporcionar a los clientes la pieza de repuesto del cierre de puerta, incluidas las instrucciones de reparación conforme al Reglamento (UE) 2019/2023. No obstante, nos gustaría resaltar que después de reemplazar el cierre de la puerta, es necesario que un electricista cualificado realice una prueba de seguridad electrotécnica antes de poner el aparato en funcionamiento. Esta persona debe estar cualificada (de forma verificable) de acuerdo con las leyes, reglamentos y normas específicos del país.

	<b>⚠ PELIGRO</b>
	<p><b>¡Riesgo de descarga eléctrica debido a piezas con tensión!</b>                  Peligro mortal por descarga eléctrica en caso de reparación inadecuada</p> <ul style="list-style-type: none"> <li>▶ Las piezas eléctricas deberían ser reparadas por electricistas cualificados.</li> <li>▶ Después de la reparación, encargar una prueba de seguridad conforme a VDE 0701 o los reglamentos específicos del país.</li> </ul>

	<b>⚠ ADVERTENCIA</b>
	<p><b>¡Deslizamiento de aparatos inclinados!</b>                  Fracturas óseas / lesiones por aplastamiento</p> <ul style="list-style-type: none"> <li>▶ Asegurar los electrodomésticos contra deslizamientos.</li> </ul>

	<b>⚠ PRECAUCIÓN</b>
	<p><b>¡Bordes de la carcasa cortantes!</b>                  Peligro de cortes</p> <ul style="list-style-type: none"> <li>▶ Usar guantes de seguridad.</li> </ul>

	<b>⚠ PRECAUCIÓN</b>
	<p><b>¡Riesgo de que se caigan piezas debido a los tornillos aflojados!</b>                  Peligro de lesiones debido a piezas que caigan.</p> <ul style="list-style-type: none"> <li>▶ Asegure el componente para que no se caiga.</li> </ul>

	<b>⚠ ATENCION</b>
	<p><b>¡Riesgo de que se caigan piezas debido a los tornillos aflojados!</b>                  Daños en otras partes del aparato o en el domicilio del consumidor, p. ej., en la parte inferior.</p> <ul style="list-style-type: none"> <li>▶ Asegure el componente para que no se caiga.</li> </ul>

### Requisito:

- ✓ El aparato está desconectado del suministro eléctrico.
- ✓ El aparato está desconectado del suministro de agua.
- ✓ Puede accederse libremente al aparato.
- ✓ [Se ha retirado la tapa superior.→411](#)
- ✓ [Se ha retirado el compartimento para detergente.→412](#)
- ✓ [Se ha retirado el panel de mandos.→414](#)
- ✓ [Se ha retirado la puerta.→416](#)
- ✓ Se ha retirado el anillo de fijación.
- ✓ [Se ha retirado la junta de la puerta.→419](#)
- ✓ [Se ha retirado la tapa de la bomba.→418](#)
- ✓ [Se ha retirado el panel frontal.→423](#)

### 4.9.1 Extraer el cierre de la puerta

1. Desconectar el enchufe del cierre de la puerta.
2. Abrir el cierre de la puerta.



3. Retirar el cierre de la puerta.

### 4.9.2 Montar el cierre de la puerta

El cierre de la puerta debe estar en la posición correcta para garantizar la función del aparato para apertura de emergencia de la puerta.

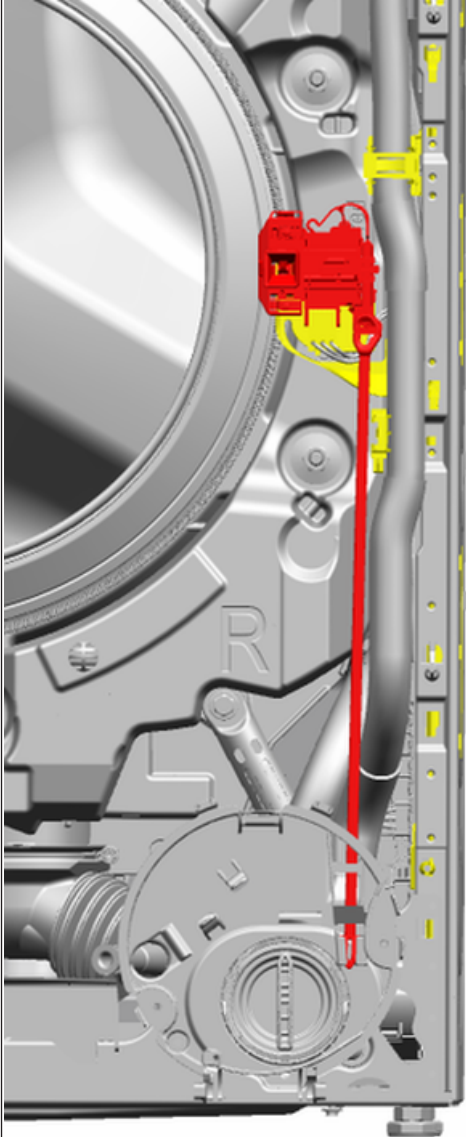



- ▶ Montar en orden inverso.

## 4.10 Sustituir la iluminación del tambor

	<b>⚠ ADVERTENCIA</b> <b>¡Deslizamiento de aparatos inclinados!</b> Fracturas óseas / lesiones por aplastamiento ▶ Asegurar los electrodomésticos contra deslizamientos.
--	--

	<b>⚠ PRECAUCIÓN</b> <b>¡Bordes de la carcasa cortantes!</b> Peligro de cortes ▶ Usar guantes de seguridad.
--	---

	<b>⚠ PRECAUCIÓN</b> <b>¡Riesgo de que se caigan piezas debido a los tornillos aflojados!</b> Peligro de lesiones debido a piezas que caigan. ▶ Asegure el componente para que no se caiga.
--	---

	<b>⚠ ATENCION</b> <b>¡Riesgo de que se caigan piezas debido a los tornillos aflojados!</b> Daños en otras partes del aparato o en el domicilio del consumidor, p. ej., en la parte inferior. ▶ Asegure el componente para que no se caiga.
--	---

### Requisito:

- ✓ El aparato está desconectado del suministro eléctrico.
- ✓ El aparato está desconectado del suministro de agua.
- ✓ Puede accederse libremente al aparato.
- ✓ [Se ha retirado la tapa superior.→411](#)
- ✓ [Se ha retirado el compartimento para detergente.→412](#)
- ✓ [Se ha retirado el panel de mandos.→414](#)

### 4.10.1 Desmontar la iluminación del tambor

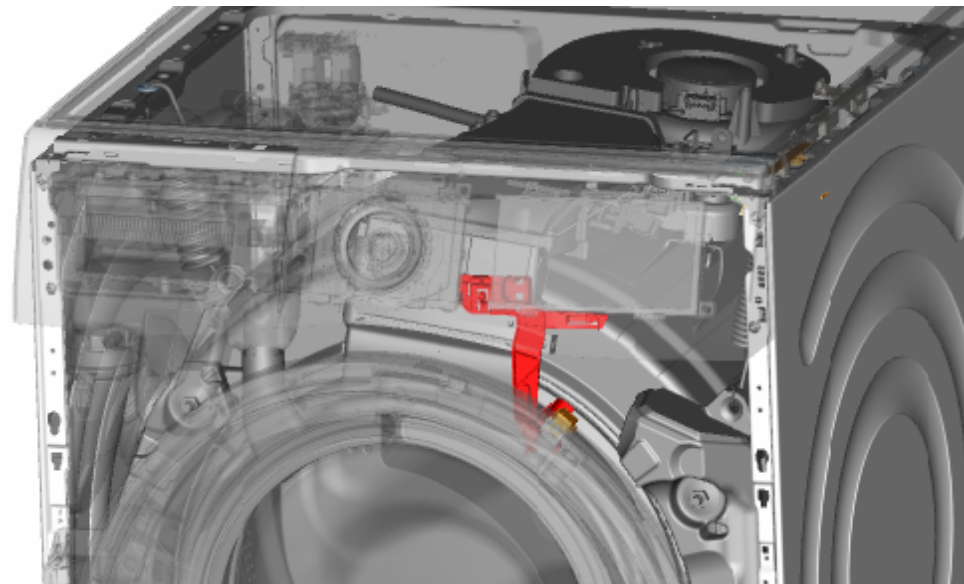

1. Sacar del aparato el soporte de la iluminación del tambor.
2. Desconectar las conexiones eléctricas.
3. Desmontar la iluminación del tambor del soporte.

### 4.10.2 Montar la iluminación del tambor

	Observar el montaje del cable. El cable podría estar atrapado.
---	--

- ▶ Montar en orden inverso.

## 4.11 Sustituir el panel frontal



### ⚠️ ADVERTENCIA

**¡Deslizamiento de aparatos inclinados!**  
Fracturas óseas / lesiones por aplastamiento  
▶ Asegurar los electrodomésticos contra deslizamientos.



### ⚠️ PRECAUCIÓN

**¡Bordes de la carcasa cortantes!**  
Peligro de cortes  
▶ Usar guantes de seguridad.



### ⚠️ PRECAUCIÓN

**¡Riesgo de que se caigan piezas debido a los tornillos aflojados!**  
Peligro de lesiones debido a piezas que caigan.  
▶ Asegure el componente para que no se caiga.



### ⚠️ ATENCION

**¡Riesgo de que se caigan piezas debido a los tornillos aflojados!**  
Daños en otras partes del aparato o en el domicilio del consumidor,  
p. ej., en la parte inferior.  
▶ Asegure el componente para que no se caiga.

### Requisito:

- ✓ El aparato está desconectado del suministro eléctrico.
- ✓ El aparato está desconectado del suministro de agua.
- ✓ Puede accederse libremente al aparato.
- ✓ [Se ha retirado la tapa superior.→411](#)
- ✓ [Se ha retirado el compartimento para detergente.→412](#)
- ✓ [Se ha retirado el panel de mandos.→414](#)
- ✓ [Se ha retirado la puerta.→416](#)
- ✓ [Se ha retirado la tapa de la bomba.→418](#)
- ✓ Se ha retirado el anillo de fijación.
- ✓ Se ha retirado la junta de la puerta en la parte delantera.
- ✓ [Se ha retirado la iluminación del tambor \(opcional\).→422](#)

### 4.11.1 Extraer el panel frontal

1. Levantar el aparato por delante.
2. Aflojar los tornillos de la parte inferior (1).

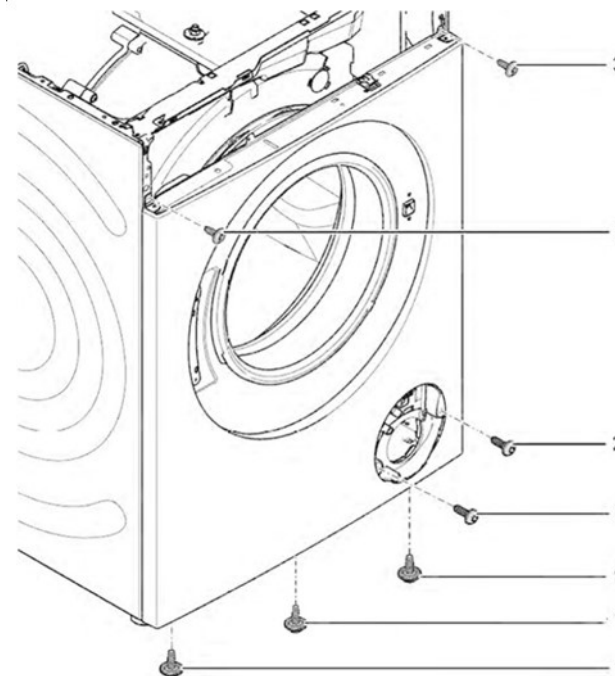

3. Bajar el aparato.

## Reparación

4. Retirar los tornillos de la parte frontal empezando por la parte inferior hasta la superior (2, 3).

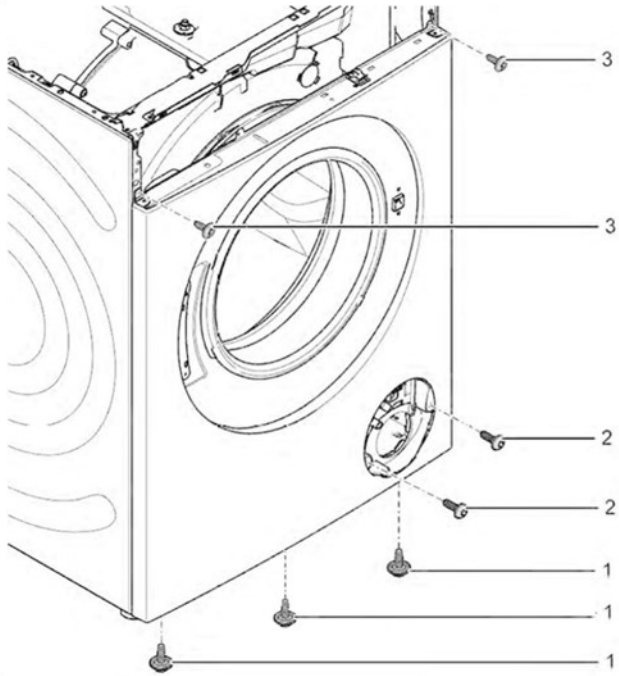

5. Retirar el panel frontal.

### 4.11.2 Montar el panel frontal

- ▶ Montar en orden inverso.

# Reparationsinformation - Tvättmaskin

## Om detta dokument..... 426

1.1	Viktig information.....	426
1.1.1	Syfte .....	426
1.2	Symbolförklaringar.....	426
1.2.1	Faronivåer .....	426
1.2.2	Risksymboler.....	426
1.2.3	Varningarnas struktur.....	427
1.2.4	Allmänna symboler.....	427

## Säkerhet..... 428

2.1	Allmänna säkerhetsanvisningar.....	428
2.1.1	Alla hushållsmaskiner.....	428

## Verktyg och hjälpmedel..... 429

## Reparation ..... 430

4.1	Byta arbetsbänk .....	430
4.1.1	Ta bort arbetsbänk.....	430
4.1.2	Montera arbetsbänk .....	430
4.2	Byta tvättmedelsfack.....	431
4.2.1	Ta bort tvättmedelsfack.....	431
4.2.2	Montera tvättmedelsfack.....	431
4.3	Byta handtag till tvättmedelsfack .....	432
4.3.1	Ta bort handtag till tvättmedelsfack.....	432
4.3.2	Montera handtag till tvättmedelsfack .....	432
4.4	Byta kontrollpanel.....	433
4.4.1	Ta bort kontrollpanel .....	433
4.4.2	Montera kontrollpanel.....	434
4.5	Byta lucka .....	435
4.5.1	Ta bort lucka.....	435
4.5.2	Montera lucka .....	435
4.6	Byta luckans komponenter .....	436
4.6.1	Ta bort luckans komponenter.....	436
4.6.2	Montera luckans komponenter.....	436
4.7	Byta pumphölje .....	437
4.7.1	Ta bort pumphölje .....	437
4.7.2	Montera pumphölje .....	437

4.8	Byta luckans tätning .....	438
4.8.1	Ta bort luckans tätning.....	438
4.8.2	Montera luckans tätning .....	438
4.9	Byta luckans lås.....	439
4.9.1	Ta bort luckans lås .....	439
4.9.2	Montera luckans lås.....	440
4.10	Byta trummans lampa .....	441
4.10.1	Ta bort trummans lampa .....	441
4.10.2	Montera luckans lampa .....	441
4.11	Byta frontpanel .....	442
4.11.1	Ta bort frontpanel .....	442
4.11.2	Montera frontpanel .....	443

# **i** Om detta dokument

## 1.1 Viktig information

### 1.1.1 Syfte

Dessa reparationstips hjälper kunden att själv reparera maskiner enligt gällande ekodesignbestämmelser (som gäller 03/2021).





De innehåller information om hur vissa reservdelar ska bytas samt tillhörande varningar och risker.

Kontakta vår kundtjänst om du har frågor. Vi åtar oss bara ansvar för skador om reparationstipsen har följts korrekt.

## 1.2 Symbolförklaringar

### 1.2.1 Faronivåer

Varningsnivåerna består av en symbol och ett signalord. Signalordet visar hur allvarlig faran är.





Varningsnivå	Innebörd
	Om inte varningsmeddelandet följs kommer det att leda till dödsfall eller allvarliga personskador.
	Om inte varningsmeddelandet följs kan det leda till dödsfall eller allvarliga personskador.
	Om inte varningsmeddelandet följs kan det leda till lättare personskador.
	Om inte varningsmeddelandet följs kan det leda till materialskador.

Grafik 1: Faronivåer



### 1.2.2 Risksymboler

Risksymboler är symboler som visar typen av fara.

Följande risksymboler används i detta dokument:

Risksymbol	Innebörd
	Allmänt varningsmeddelande
	Fara på grund av elektrisk spänning
	Explosionsrisk
	Fara för skärskador
	Fara för krosskador

## i Om detta dokument

Risksymbol	Innebörd
	Fara på grund av heta ytor
	Fara på grund av starka magnetfält
	Fara på grund av icke-joniserande strålning

Grafik 2: Risksymboler

### 1.2.3 Varningarnas struktur

Varningar i detta dokument har ett standardiserat utseende och en standardiserad struktur.



	<p> <b>FARA!</b></p> <p><b>Farans typ och ursprung!</b> Möjliga konsekvenser av att faran/varningen ignoreras.</p> <ul style="list-style-type: none"> <li>▶ Åtgärder och förbud för att förebygga faran.</li> </ul>
--	--





Följande exempel visar en varning som varnar för elstötar från strömförande delar. Det står vilken åtgärd som förebygger faran.

	<p> <b>FARA!</b></p> <p><b>Risk för elstötar på grund av strömförande delar!</b> Dödsfall på grund av elstötar</p> <ul style="list-style-type: none"> <li>▶ Koppla bort maskiner från elförsörjningen minst 60 sekunder innan reparationer påbörjas.</li> </ul>
---	---

### 1.2.4 Allmänna symboler

Följande allmänna symboler används i detta dokument:

Allm. symbol	Innebörd
	Identifiering av ett särskilt tips (text och/eller bild)
	Identifiering av ett enkelt tips (endast text)

Allm. symbol	Innebörd
	Identifiering av en länk till en videohandledning
	Identifiering av verktyg som behövs
	Identifiering av villkor som måste vara uppfyllda
	Identifiering av ett tillstånd (om ..., så ...)
	Identifiering av ett resultat
[Start]	Identifiering av en tangent eller knapp
[00123456]	Identifiering av ett materialnummer
Status	Identifiering av text/fönster som visas (i maskinens display)

Grafik 3: Allmänna symboler

## 2.1 Allmänna säkerhetsanvisningar

### 2.1.1 Alla hushållsmaskiner

#### **Risk för elstötar på grund av strömförande delar!**

- Fel vid reparationer som berör elkomponenter kan orsaka elstötar!
- Koppla bort maskinen från elnätet minst 60 sekunder innan arbetet påbörjas.
- Låt utföra ett säkerhetstest efter reparationen, i enlighet med VDE 0701 eller landsspecifika regler.

#### **Risk för personskador på grund av vassa kanter!**

- Använd skyddshandskar.

#### **Risk för krosskador vid reparation, underhåll, felsökning och service på grund av tunga och rörliga komponenter**

- Använd skyddsskor.
- Säkra tunga komponenter så att de inte faller ner.
- Stick inte in kroppsdelar i rörliga komponenter.







#### **Risk för maskinens säkerhet/funktion!**





- Använd endast originaldelar.

#### **Risk för skador på komponenter känsliga för statisk elektricitet (ESD)!**

- Rör inte modulerna samt anslutningar och strömförande ledningar.

## Verktyg och hjälpmedel

Beteckning	Detaljer	Bilder
Hjälpverktyg [15000155]	Verktyg för att lossa plastdelar	
Skruvmejsel torx T20 med borrhål [00340764]	100 mm, för skruvar med säkerhetsstift	
Momentnyckel [15000441]	Momentnyckel 20 - 100 Nm	
Spårskruvmejsel [00340854]	Blad 3,5 mm x 0,6 mm x 100 mm, skyddsisolering 1000 V AC	
Spårskruvmejsel [00340855]	Blad 5,5 mm x 1,0 mm x 125 mm, skyddsisolering 1000 V AC	
Spetstång, böjd [00341269]	Längd 200 mm	
Sidavbitare [00342182]	Längd: 200 mm	



Beteckning	Detaljer	Bilder
Kombinationsnyckel [00340811]	Skiftnyckelstorlek 10 <sup>o</sup> mm, M6	
Combination w- rench [00340814]	Skiftnyckelstorlek 13 <sup>o</sup> mm, M8	
Kombinationsnyckel [00340817]	Skiftnyckelstorlek 17 mm, M10	
Kombinationsnyckel [15000459]	Skiftnyckelstorlek 16 <sup>o</sup> mm, M10	

## 4.1 Byta arbetsbänk

### Nödvändiga verktyg:

- |  |  |            |
|--|--|------------|
|  Torx Bit TX20 med hål | Längd 152 mm, användbar längd 124 mm, 1/4" sexkantdrivning (6,35 mm), för skruvar med säkerhetsstift | [00341272] |
|--|--|------------|

### Förutsättning:

-  Apparaten är bortkopplad från strömförsörjning.
-  Apparaten är bortkopplad från vattenförsörjning.

### 4.1.1 Ta bort arbetsbänk

- ▶ 1. Ta bort skruvarna (1).
- 2. Tryck arbetsbänken mot maskinens baksida (2).
- 3. Flytta arbetsbänken uppåt (3) för att ta bort den.

### 4.1.2 Montera arbetsbänk



Var noga med kabeldragningen. Kabeln kan fastna.

- ▶ Montera i omvänd ordning.

## 4.2 Byta tvättmedelsfack

### Förutsättning:

- ✓ Apparatens är bortkopplad från strömförsörjning.
- ✓ Apparatens är bortkopplad från vattenförsörjning.

### 4.2.1 Ta bort tvättmedelsfack

1. Dra ut tvättmedelsfacket.
2. 1. Tryck nedåt på insatsen (1).  
2. Ta ut tvättmedelsfacket (2).

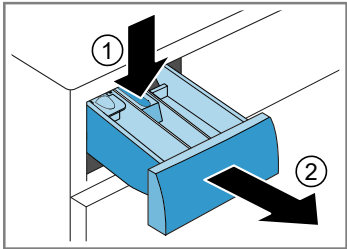

### 4.2.2 Montera tvättmedelsfack

- ▶ Montera i omvänd ordning.

## 4.3 Byta handtag till tvättmedelsfack

### Förutsättning:

- ✓ Apparaten är bortkopplad från strömförsörjning.
- ✓ Apparaten är bortkopplad från vattenförsörjning.
- ✓ [Tvättmedelsfacket har tagits bort.](#)→431

### 4.3.1 Ta bort handtag till tvättmedelsfack

1. Lossa fästelementen.

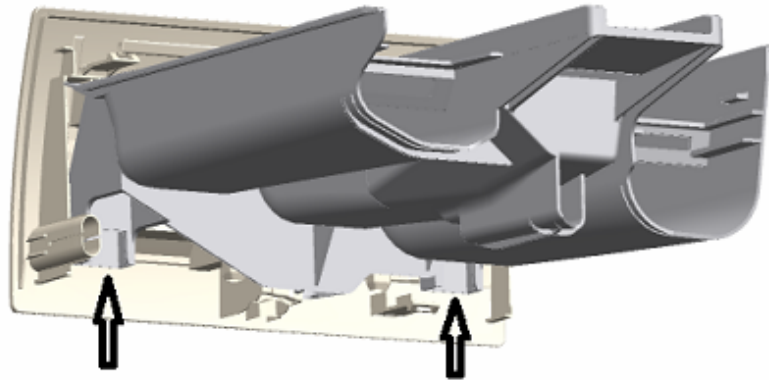





2. Ta bort handtaget till tvättmedelsfacket.

### 4.3.2 Montera handtag till tvättmedelsfack

- ▶ Montera i omvänd ordning.

## 4.4 Byta kontrollpanel

Som tillverkare är vi skyldiga att förse våra kunder med reservdelen instrumentpanel inklusive reparationsanvisningar i enlighet med förordning (EU) 2019/2023. Vi vill dock gärna påpeka att det efter byte av en instrumentpanel krävs en elektroteknisk säkerhetsprovning utförd av en behörig elektriker innan apparaten får tas i drift. Denna person måste kunna uppvisa bevis på sin behörighet enligt landsspecifika lagar, förordningar, och normer.

	<p style="text-align: center;"><b>FARA!</b></p> <p><b>Risk för elstötar på grund av strömförande delar!</b> Livsfara på grund av elstötar vid felaktiga reparationer</p> <ul style="list-style-type: none"> <li>▶ Elektriska delar ska repareras av behörig elektriker.</li> <li>▶ Låt utföra ett säkerhetstest efter reparationen, i enlighet med VDE 0701 eller landsspecifika regler.</li> </ul>
	<p style="text-align: center;"><b>VARNING!</b></p> <p><b>Lutande maskiner kan glida!</b> Frakturer/krosskador</p> <ul style="list-style-type: none"> <li>▶ Säkra maskiner så att de inte kan glida.</li> </ul>
	<p style="text-align: center;"><b>FÖRSIKTIGT!</b></p> <p><b>Vassa höljeskanter!</b> Skärskador</p> <ul style="list-style-type: none"> <li>▶ Använd skyddshandskar.</li> </ul>
	<p style="text-align: center;"><b>FÖRSIKTIGT!</b></p> <p><b>Risk för fallande delar på grund av lossade skruvar!</b> Personskador på grund av fallande delar.</p> <ul style="list-style-type: none"> <li>▶ Säkra komponenter så att de inte faller ner.</li> </ul>
	<p style="text-align: center;"><b>OBS!</b></p> <p><b>Risk för fallande delar på grund av lossade skruvar!</b> Materiella skador på andra delar av maskinen eller i kundens hem, t.ex. vid botten.</p> <ul style="list-style-type: none"> <li>▶ Säkra komponenter så att de inte faller ner.</li> </ul>

### Förutsättning:

- ✓ Apparaten är bortkopplad från strömförsörjning.
- ✓ Apparaten är bortkopplad från vattenförsörjning.

- ✓ [Arbetskivan har demonterats.→430](#)
- ✓ [Tvättmedelsfacket har tagits bort.→431](#)

### 4.4.1 Ta bort kontrollpanel

1. Ta bort skruvarna (1).
2. Lossa fästelementen (2, 3).

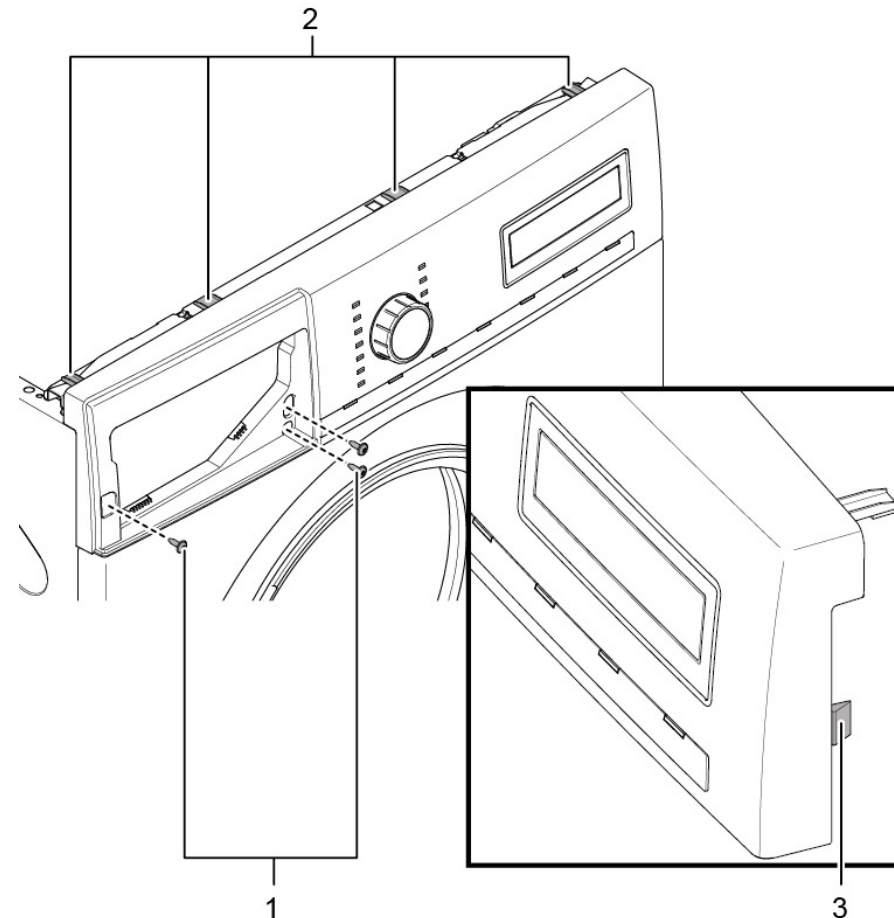

2. Lossa stickkontakten till styrenheten.
3. Ta bort kontrollpanelen.

## 4.4.2 Montera kontrollpanel



Var noga med kabeldragningen. Kabeln kan fastna.

- ▶ Montera i omvänd ordning.

## 4.5 Byta lucka



### ⚠️ FÖRSIKTIGT!

#### Öppna gångjärnsdelen!

Risk för att fingrar krossas/fastnar

- ▶ Stick inte in händerna i gångjärnsdelen.
- ▶ Använd skyddshandskar.



### ⚠️ FÖRSIKTIGT!

#### Risk för fallande delar på grund av lossade skruvar!

Personskador på grund av fallande delar.

- ▶ Säkra komponenter så att de inte faller ner.



### OBS!

#### Risk för fallande delar på grund av lossade skruvar!

Materiella skador på andra delar av maskinen eller i kundens hem, t.ex. vid botten.

- ▶ Säkra komponenter så att de inte faller ner.

#### Förutsättning:

- ✔ Apparaten är bortkopplad från strömförsörjning.
- ✔ Apparaten är bortkopplad från vattenförsörjning.
- ✔ Luckan är öppen.

### 4.5.1 Ta bort lucka

1. Ta bort skruvarna (1).

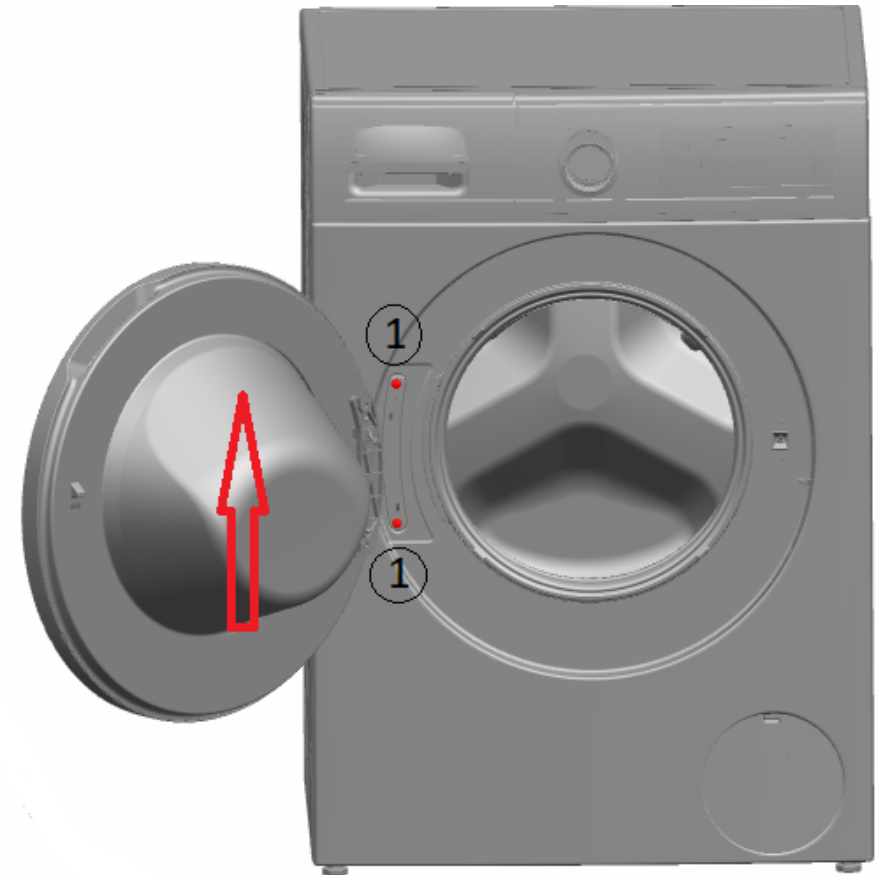

2. Ta bort luckan uppåt.

### 4.5.2 Montera lucka

- ▶ Montera i omvänd ordning.

## 4.6 Byta luckans komponenter

	<b>⚠ VARNING!</b>
	<b>Tunga och rörliga komponenter!</b> Risk för klämskador under reparation, underhåll, felsökning och service <ul style="list-style-type: none"><li>▶ Använd skyddsskor.</li><li>▶ Säkra tunga komponenter så att de inte kan falla ned.</li><li>▶ Stick inte in kroppsdelar i rörliga komponenter.</li></ul>

	<b>⚠ FÖRSIKTIGT!</b>
	<b>Öppna gångjärnsdelen!</b> Risk för att fingrar krossas/fastnar <ul style="list-style-type: none"><li>▶ Stick inte in händerna i gångjärnsdelen.</li><li>▶ Använd skyddshandskar.</li></ul>

### Förutsättning:

- ✓ Apparatens är bortkopplad från strömförsörjning.
- ✓ Apparatens är bortkopplad från vattenförsörjning.
- ✓ [Luckan har tagits bort. → 435](#)

### 4.6.1 Ta bort luckans komponenter

- ▶ Demontera luckan utifrån och in.

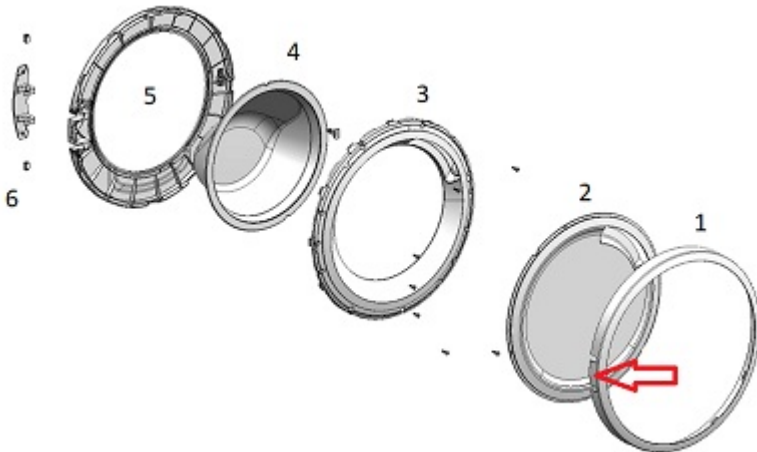

### 4.6.2 Montera luckans komponenter

- ▶ Montera i omvänd ordning.

## 4.7 Byta pumphölje

### Förutsättning:

- ✓ Apparatens är bortkopplad från strömförsörjning.
- ✓ Apparatens är bortkopplad från vattenförsörjning.

### 4.7.1 Ta bort pumphölje

1. Öppna pumphöljet.

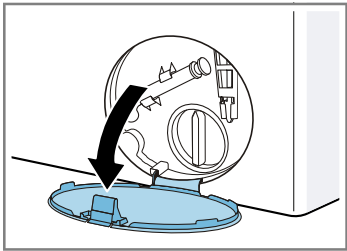

2. Ta bort pumphöljet.

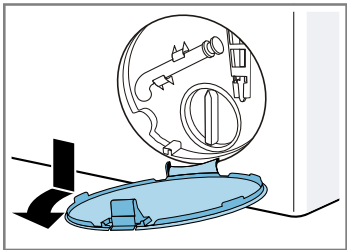

### 4.7.2 Montera pumphölje

- ▶ Montera i omvänd ordning.

## 4.8 Byta luckans tätning



### ⚠ FÖRSIKTIGT!

**Vassa höljeskanter!**  
Skärskador  
▶ Använd skyddshandskar.



### ⚠ FÖRSIKTIGT!

**Risk för fallande delar på grund av lossade skruvar!**  
Personskador på grund av fallande delar.  
▶ Säkra komponenter så att de inte faller ner.



### OBS!

**Risk för fallande delar på grund av lossade skruvar!**  
Materiella skador på andra delar av maskinen eller i kundens hem, t.ex. vid botten.  
▶ Säkra komponenter så att de inte faller ner.

### Förutsättning:

- ✓ Apparaten är bortkopplad från strömförsörjning.
- ✓ Apparaten är bortkopplad från vattenförsörjning.
- ✓ Maskinen är fritt åtkomlig.
- ✓ [Arbetskivan har demonterats.→430](#)
- ✓ [Tvättmedelsfacket har tagits bort.→431](#)
- ✓ [Instrumentpanelen har demonterats.→433](#)
- ✓ [Luckan har tagits bort.→435](#)
- ✓ [Pumphöljet har tagits bort.→437](#)
- ✓ [Frontpanelen har demonterats.→442](#)
- ✓ [Trumlampan har demonterats \(tillval\).→441](#)

## 4.8.1 Ta bort luckans tätning

1. Lossa alla slangkopplingar.

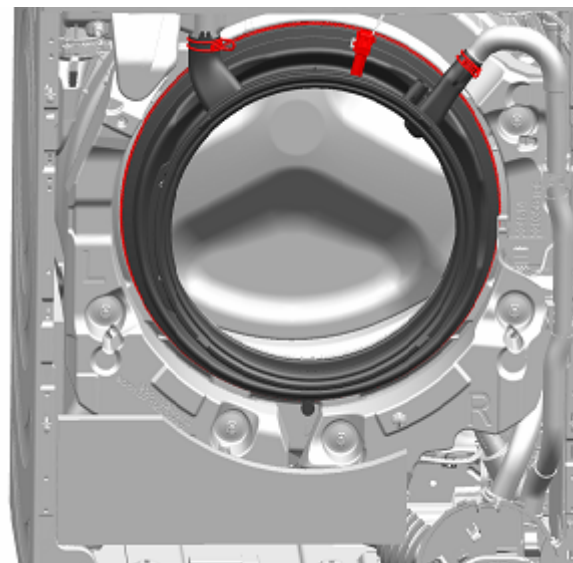

2. Ta bort lucktätningen.

## 4.8.2 Montera luckans tätning



### ⚠ VARNING!

**Risk för fallande delar på grund av felaktig montering!**  
Personskador eller maskinskador.  
▶ Dra åt lucktätningens spänning med 3,4 Nm.

- ▶ Montera i omvänd ordning.

## 4.9 Byta luckans lås

Som tillverkare är vi skyldiga att förse våra kunder med reservdelen lucklås inklusive reparationsanvisningar i enlighet med förordning (EU) 2019/2023. Vi vill dock gärna påpeka att det efter byte av ett lucklås krävs en elektroteknisk säkerhetsprovning utförd av en behörig elektriker innan apparaten får tas i drift. Denna person måste kunna uppvisa bevis på sin behörighet enligt landsspecifika lagar, förordningar, och normer.

	<b>FARA!</b>
	<b>Risk för elstötar på grund av strömförande delar!</b> Livsfara på grund av elstötar vid felaktiga reparationer <ul style="list-style-type: none"><li>▶ Elektriska delar ska repareras av behörig elektriker.</li><li>▶ Låt utföra ett säkerhetstest efter reparationen, i enlighet med VDE 0701 eller landsspecifika regler.</li></ul>

	<b>VARNING!</b>
	<b>Lutande maskiner kan glida!</b> Frakturer/krosskador <ul style="list-style-type: none"><li>▶ Säkra maskiner så att de inte kan glida.</li></ul>

	<b>FÖRSIKTIGT!</b>
	<b>Vassa höljeskanter!</b> Skärskador <ul style="list-style-type: none"><li>▶ Använd skyddshandskar.</li></ul>

	<b>FÖRSIKTIGT!</b>
	<b>Risk för fallande delar på grund av lossade skruvar!</b> Personskador på grund av fallande delar. <ul style="list-style-type: none"><li>▶ Säkra komponenter så att de inte faller ner.</li></ul>

	<b>OBS!</b>
	<b>Risk för fallande delar på grund av lossade skruvar!</b> Materiella skador på andra delar av maskinen eller i kundens hem, t.ex. vid botten. <ul style="list-style-type: none"><li>▶ Säkra komponenter så att de inte faller ner.</li></ul>

### Förutsättning:

- ✓ Apparaten är bortkopplad från strömförsörjning.
- ✓ Apparaten är bortkopplad från vattenförsörjning.

- ✓ Maskinen är fritt åtkomlig.
- ✓ [Arbetskivan har demonterats.→430](#)
- ✓ [Tvättmedelsfacket har tagits bort.→431](#)
- ✓ [Instrumentpanelen har demonterats.→433](#)
- ✓ [Luckan har tagits bort.→435](#)
- ✓ Spännringen har tagits bort.
- ✓ [Lucktätningen har tagits bort.→438](#)
- ✓ [Pumphöljet har tagits bort.→437](#)
- ✓ [Frontpanelen har demonterats.→442](#)

### 4.9.1 Ta bort luckans lås

1. Dra ur kontakten till luckans lås.
2. Lossa luckans lås.



3. Ta bort luckans lås.

### 4.9.2 Montera luckans lås

Luckans lås måste vara i rätt läge för att maskinens nödöppning av luckan ska fungera.

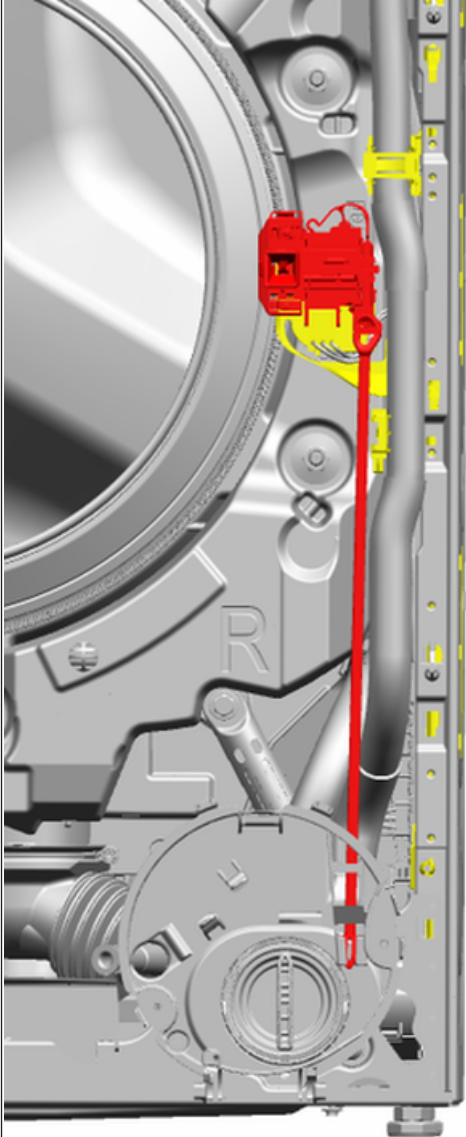

- ▶ Montera i omvänd ordning.

## 4.10 Byta trummans lampa



### ⚠ VARNING!

**Lutande maskiner kan glida!**

Frakturer/krosskador

- ▶ Säkra maskiner så att de inte kan glida.



### ⚠ FÖRSIKTIGT!

**Vassa höljeskanter!**

Skärskador

- ▶ Använd skyddshandskar.



### ⚠ FÖRSIKTIGT!

**Risk för fallande delar på grund av lossade skruvar!**

Personskador på grund av fallande delar.

- ▶ Säkra komponenter så att de inte faller ner.



### OBS!

**Risk för fallande delar på grund av lossade skruvar!**

Materiella skador på andra delar av maskinen eller i kundens hem, t.ex. vid botten.

- ▶ Säkra komponenter så att de inte faller ner.

### Förutsättning:

- ✓ Apparaten är bortkopplad från strömförsörjning.
- ✓ Apparaten är bortkopplad från vattenförsörjning.
- ✓ Maskinen är fritt åtkomlig.
- ✓ [Arbetsskivan har demonterats.→430](#)
- ✓ [Tvättmedelsfacket har tagits bort.→431](#)
- ✓ [Instrumentpanelen har demonterats.→433](#)

## 4.10.1 Ta bort trummans lampa

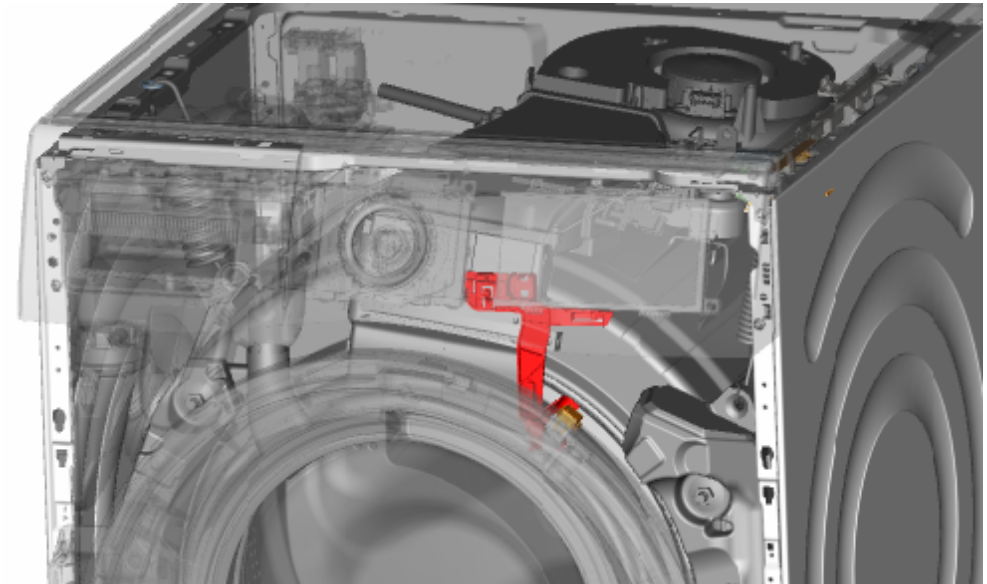

1. Dra ut trummans lampa från maskinen.
2. Lossa elanslutningarna.
3. Ta bort trummans lampa från lamphållaren.

## 4.10.2 Montera luckans lampa



Var noga med kabeldragningen. Kabeln kan fastna.

- ▶ Montera i omvänd ordning.

## 4.11 Byta frontpanel



### ⚠️ VARNING!

#### Lutande maskiner kan glida!

Frakturer/krosskador

- ▶ Säkra maskiner så att de inte kan glida.



### ⚠️ FÖRSIKTIGT!

#### Vassa höljeskanter!

Skärskador

- ▶ Använd skyddshandskar.



### ⚠️ FÖRSIKTIGT!

#### Risk för fallande delar på grund av lossade skruvar!

Personskador på grund av fallande delar.

- ▶ Säkra komponenter så att de inte faller ner.



### OBS!

#### Risk för fallande delar på grund av lossade skruvar!

Materiella skador på andra delar av maskinen eller i kundens hem, t.ex. vid botten.

- ▶ Säkra komponenter så att de inte faller ner.

#### Förutsättning:

- ✓ Apparaten är bortkopplad från strömförsörjning.
- ✓ Apparaten är bortkopplad från vattenförsörjning.
- ✓ Maskinen är fritt åtkomlig.
- ✓ [Arbetsskivan har demonterats.→430](#)
- ✓ [Tvättmedelsfacket har tagits bort.→431](#)
- ✓ [Instrumentpanelen har demonterats.→433](#)
- ✓ [Luckan har tagits bort.→435](#)
- ✓ [Pumphöljet har tagits bort.→437](#)
- ✓ Spännringen har tagits bort.
- ✓ Lucktätningen har frigjorts vid fronten.
- ✓ [Trumlampan har demonterats \(tillval\).→441](#)

### 4.11.1 Ta bort frontpanel

1. Lyft upp maskinen i fronten.
2. Ta bort skruvarna vid botten (1).

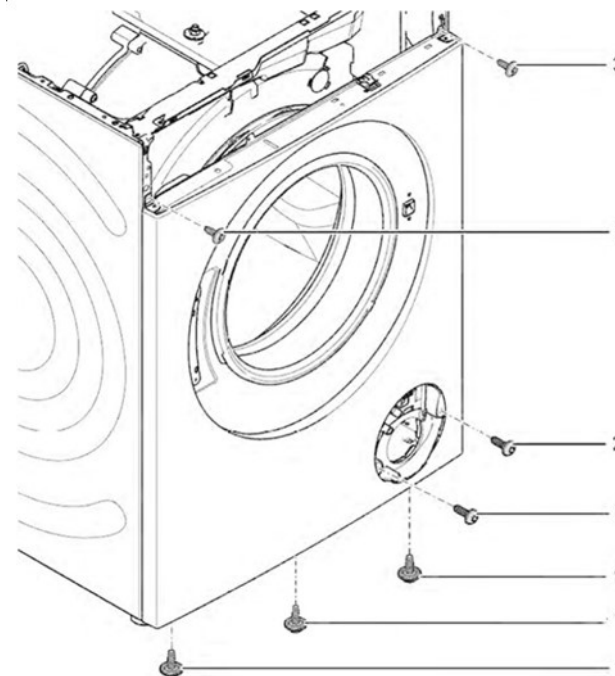

3. Sänk ned maskinen.

4. Ta bort skruvarna i fronfen nedifrån och uppåt (2, 3).

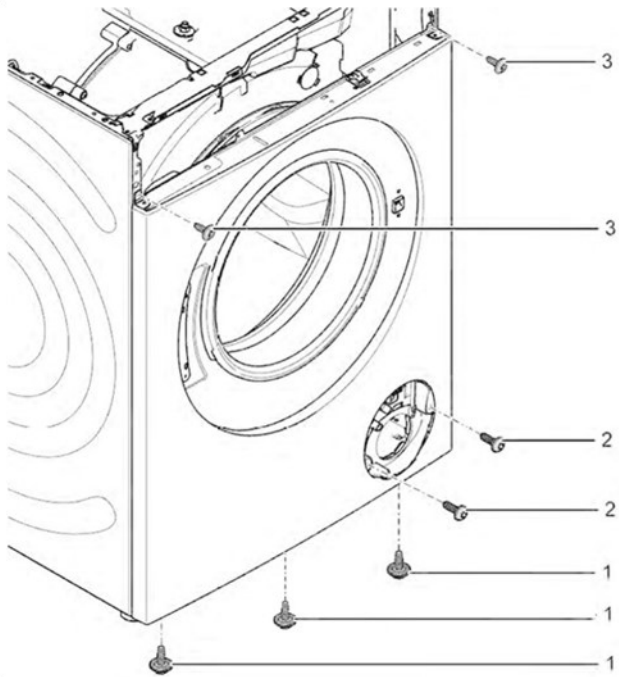

5. Ta bort frontpanelen.

### 4.11.2 Montera frontpanel

- ▶ Montera i omvänd ordning.

# Onarım İpuçları - Çamaşır makinesi

<b>i</b>	<b>Bu doküman hakkında .....</b>	<b>445</b>
1.1	Önemli bilgi .....	445
1.1.1	Amacı.....	445
1.2	Sembollerinin açıklaması .....	445
1.2.1	Tehlike kademeleri .....	445
1.2.2	Tehlike sembolleri .....	445
1.2.3	İkaz bilgilerinin yapısı .....	446
1.2.4	Genel semboller.....	446
<b>⚠</b>	<b>Güvenlik.....</b>	<b>447</b>
2.1	Genel Güvenlik bilgileri .....	447
2.1.1	Tüm ev gereçleri .....	447
<b>🔧</b>	<b>Ekipman ve yardım.....</b>	<b>448</b>
<b>🔧</b>	<b>Onarım.....</b>	<b>449</b>
4.1	Üst tablanın değiştirilmesi .....	449
4.1.1	Üst tablanın sökülmesi .....	449
4.1.2	Üst tablanın monte edilmesi.....	449
4.2	Deterjan bölmesinin değiştirilmesi.....	450
4.2.1	Deterjan bölmesinin sökülmesi.....	450
4.2.2	Deterjan bölmesinin takılması .....	450
4.3	Deterjan bölmesi tutamağının değiştirilmesi .....	451
4.3.1	Deterjan bölmesi tutamağının sökülmesi .....	451
4.3.2	Deterjan bölmesi tutamağının takılması .....	451
4.4	Gösterge panelinin değiştirilmesi .....	452
4.4.1	Gösterge panelinin sökülmesi .....	452
4.4.2	Gösterge panelinin takılması.....	453
4.5	Kapının değiştirilmesi.....	454
4.5.1	Kapının sökülmesi.....	454
4.5.2	Kapının takılması .....	454
4.6	Kapı bileşenlerinin değiştirilmesi.....	455
4.6.1	Kapı bileşenlerinin sökülmesi .....	455
4.6.2	Kapı bileşenlerinin takılması .....	455
4.7	Pompa kapağının değiştirilmesi .....	456
4.7.1	Pompa kapağının sökülmesi .....	456
4.7.2	Pompa kapağının takılması .....	456

4.8	Kapı contasının değiştirilmesi .....	457
4.8.1	Kapı contasının sökülmesi .....	457
4.8.2	Kapı contasının takılması .....	457
4.9	Kapı kilidinin değiştirilmesi.....	458
4.9.1	Kapı kilidinin sökülmesi .....	458
4.9.2	Kapı kilidinin monte edilmesi .....	459
4.10	Tambur lambasının değiştirilmesi.....	460
4.10.1	Tambur lambasının sökülmesi.....	460
4.10.2	Tambur lambasının takılması .....	460
4.11	Ön panelin değişimi.....	461
4.11.1	Ön panelin sökülmesi .....	461
4.11.2	Ön sacın takılması.....	462

# **i** Bu doküman hakkında

## 1.1 Önemli bilgi

### 1.1.1 Amacı

Bu onarım ipuçları, tüketicinin cihazları, geçerli eko-tasarım yönetmeliğine göre (03/2021 itibarıyla) kendi başına onarması için destek sunar.

İpuçları, ilgili uyarı ve riskler de dahil olmak üzere tanımlanmış yedek parçaların nasıl değiştirilmesi gerektiğine dair bilgiler içerir.

Sorularınız varsa, lütfen müşteri hizmetlerimizle irtibata geçin. Yalnızca onarım ipuçlarına gerektiği gibi uyulduğu takdirde hasarlar için sorumluluk üstleniriz.

## 1.2 Sembollerinin açıklaması

### 1.2.1 Tehlike kademeleri

Tehlike kademeleri bir sembolden ve bir sinyal kelimesinden oluşur. Sinyal kelimesi tehlikenin şiddetini ve önemini tanımlar.





Tehlike kademesi	Anlamı
 <b>TEHLİKE</b>	İkaz bilgisinin dikkate alınmaması ölüme veya ağır yaralanmalara sebep olur.
 <b>UYARI</b>	İkaz bilgisinin dikkate alınmaması ölüme veya ağır yaralanmalara sebep olabilir.
 <b>DİKKAT</b>	İkaz bilgisinin dikkate alınmaması hafif yaralanmalara sebep olabilir.
<b>DİKKATI</b>	İkaz bilgisinin dikkate alınmaması maddi hasarların oluşmasına sebep olabilir.

Tablo 1: Tehlike kademeleri



### 1.2.2 Tehlike sembolleri

Tehlike sembolleri, tehlike türü hakkında bilgi veren anlamlı resimsel gösterimlerdir.

Bu dokümanda aşağıdaki tehlike sembolleri kullanılmıştır:

Tehlike sembolü	Anlamı
	Genel ikaz bilgisi
	Elektrik geriliminden kaynaklanan tehlike
	Patlamadan kaynaklanan tehlike
	Kesmeden dolayı yaralanma tehlikesi
	Sıkışıp ezilmeden dolayı yaralanma tehlikesi

## **i** Bu doküman hakkında

Tehlike sembolü	Anlamı
	Sıcak yüzeylerden kaynaklanan tehlike
	Güçlü elektromanyetik alan tehlikesi
	İyonizasyon olmayan ışınlardan kaynaklanan tehlike

Tablo 2: Tehlike sembolleri

### 1.2.3 İkaz bilgilerinin yapısı

Bu dokümandaki ikaz bilgilerinin standart olarak görünüşü ve yapısı aynıdır.



	<b>⚠ TEHLİKE</b> <b>Tehlikenin türü ve kaynağı!!</b> Tehlike / ikaz bilgisinin dikkate alınmamasının sonucu. ► Tehlikeye karşı korunmak için yapılacak işlem ve yasaklar.
--	--







Aşağıdaki örnekte, gerilim ileten parçalar nedeniyle oluşabilecek elektrik çarpması tehlikesi hakkında uyarıda bulunan bir ikaz bilgisi gösterilmiştir. Tehlikeyi önlemek için alınması gereken önlemler belirtilmiştir.

	<b>⚠ TEHLİKE</b> <b>Gerilim ileten parçalar nedeniyle elektrik çarpması tehlikesi!!</b> Elektrik çarpması sebebiyle ölüm ► Onarıma başlamadan önce cihazın elektrik şebeke bağlantısını en az 60 saniye süreyle sökün.
--	---

### 1.2.4 Genel semboller

Bu dokümanda aşağıdaki genel semboller kullanılmıştır:

Genel sembol	Anlamı
	Özel ipucu işareti (metin ve/veya grafik)
	Basit ipucu işareti (yalnızca metin)
	Video linki işareti

Genel sembol	Anlamı
	Gerekli araçlar işareti
	Ön koşulların işareti
	Koşul işareti (... olursa .... olur)
	Sonuç işareti
	Tuş veya düğme işareti
	Malzeme numarası işareti
	Gösterilen yazı / ekran işareti (cihaz ekranındaki)

Tablo 3: Genel semboller

## 2.1 Genel Güvenlik bilgileri

### 2.1.1 Tüm ev gereçleri

#### **Gerilim ileten parçalar nedeniyle elektrik çarpması tehlikesi!**

- Elektrikli bileşenlerde yapılan onarımlarda hatalar, elektrik çarpmasına neden olabilir!
- Cihaz çalışmalara başlamadan en az 60 saniye önce elektrik şebekesinden ayrılmalıdır.
- Onarım sonrasında VDE 0701 veya ülkeye özel düzenlemeler uyarınca bir güvenlik testi gerçekleştirilmelidir.

#### **Keskin kenarlar nedeniyle yaralanma tehlikesi!**

- Koruyucu eldiven kullanılmalıdır.

#### **Ağır ve hareketli parçaların onarım, bakım, hata arama ve servis işlemlerinde yaratabileceği ezilme riskleri**

- Koruyucu ayakkabı giyin.
- Yere düşmemesi için ağır parçaları emniyete alın.
- Hareketli parçaların arasına gövde parçaları koymayın.







#### **Cihaz güvenliğinde / fonksiyonda tehlike!**

- Yalnızca orijinal parçalar kullanılmalıdır.

#### **Elektrostatik hassasiyeti olan bileşenlerde hasar tehlikesi (ESD)!**

- Bağlantılar ve iletken yolları da dahil olmak üzere modüllere dokunmayın.

## Ekipman ve yardım

Tanımlama	Detaylar	Görüntüler
Sabitleme parçası [15000155]	Plastik parçaların gevşetilmesi için alet	
Delik boşluklu Torx T20 tornavida [00340764]	100 mm, emniyet pimli vidalar için	
Tork anahtarı [15000441]	Tork anahtarı 20 - 100 Nm	
Düz tornavida [00340854]	Bıçak 3,5 mm x 0,6 mm x 100 mm, Koruyucu İzolasyon 1000 V AC	
Düz tornavida [00340855]	Bıçak 5,5 mm x 1,0 mm x 125 mm, Koruyucu İzolasyon 1000 V AC	
Kargaburun pense, açılı ağızlı [00341269]	Uzunluk 200 mm	
Yan keski [00342182]	Uzunluk: 200 mm	



Tanımlama	Detaylar	Görüntüler
Kombine Anahtar [00340811]	Anahtar boyutu 10°mm, M6	
Combination wrench [00340814]	Anahtar boyutu 13°mm, M8	
Kombine Anahtar [00340817]	Anahtar boyutu 17 mm, M10	
Kombine Anahtar [15000459]	Anahtar boyutu 16°mm, M10	

## 4.1 Üst tablanın deęiřtirilmesi

Özel yardımcı ekipman:

 Delikli Torx Bit TX20	Uzunluk 152 mm, kullanılabilir uzunluk 124 mm, 1/4 inç altıgen sürücü (6,35 mm), emniyet pimli vidalar için	[00341272]
--	---	------------

Ön koşul:

-  Cihazın fiři çekilir.
-  Cihaz, su beslemesinden ayrılır.

### 4.1.1 Üst tablanın sökülmesi

- ▶ 1. Vidaları sökün (1).
- ▶ 2. Üst tablayı cihazın arkasına doğru itin (2).
- ▶ 3. Üst tablayı sökmek için yukarıya doğru hareket ettirin (3).

### 4.1.2 Üst tablanın monte edilmesi

	Kablo montajını dikkate alın. Kablo sıkışmış olabilir.
---	--

- ▶ Ters sıra ile monte edin.

## 4.2 Deterjan bölmesinin değiştirilmesi

### Ön koşul:

- ✓ Cihazın fişi çekilir.
- ✓ Cihaz, su beslemesinden ayrılır.

### 4.2.1 Deterjan bölmesinin sökülmesi

1. Deterjan bölmesini dışarı çekin.
2. 1. Ek parçanın üzerine bastırın (1).
2. Deterjan bölmesini sökün (2).

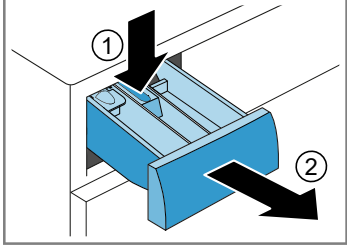

### 4.2.2 Deterjan bölmesinin takılması

- ▶ Ters sıra ile monte edin.

## 4.3 Deterjan bölmesi tutamağının değiştirilmesi

### Ön koşul:

- ✓ Cihazın fişi çekilir.
- ✓ Cihaz, su beslemesinden ayrılır.
- ✓ [Deterjan bölmesi sökülüdü.→450](#)

### 4.3.1 Deterjan bölmesi tutamağının sökülmesi

1. Tırnakları serbest bırakın.

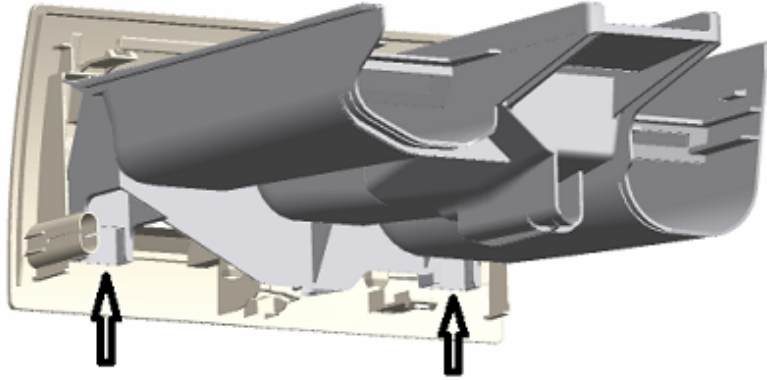

2. Deterjan bölmesi tutamağını sökün.

### 4.3.2 Deterjan bölmesi tutamağının takılması

- ▶ Ters sıra ile monte edin.

#### 4.4 Gösterge panelinin değiştirilmesi

(AB) 2019/2023 Düzenlemesi uyarınca, tüketicilere onarım talimatları ile birlikte yedek bir gösterge panelinin sağlanması üretici olarak bizim yükümlülüğümüzdür. Bununla birlikte, bir gösterge paneli değişimi sonrasında cihaz çalıştırılmadan önce kalifiye bir elektrik uzmanı tarafından mutlaka bir elektroteknik güvenlik testinin gerçekleştirilmesi gerektiğini de vurgulamak isteriz. Bu kişinin ülkeye özgü yasalar, düzenlemeler ve standartlar kapsamındaki hükümlerin gerektirdiği niteliklere sahip olduğu doğrulanabilir olmalıdır.

	<b>TEHLİKE</b> <b>Gerilim ileten parçalar nedeniyle elektrik çarpması tehlikesi!!</b> Onarımın düzgün yapılmaması nedeniyle elektrik çarpması sonucu hayati tehlike <ul style="list-style-type: none"><li>▶ Elektrikli parçaların onarımı kalifiye bir elektrik uzmanı tarafından gerçekleştirilmelidir.</li><li>▶ Onarım sonrasında VDE 0701 veya ülkeye özel düzenlemeler uyarınca bir güvenlik testi gerçekleştirilmelidir.</li></ul>
--	--

	<b>UYARI</b> <b>Eğilmiş cihazların kayması!</b> Kemik kırılmaları / çarpma sonucu yaralanmalar <ul style="list-style-type: none"><li>▶ Cihazları kaymaya karşı emniyete alın.</li></ul>
--	---

	<b>DİKKAT</b> <b>Keskin gövde kenarları!</b> Kesik yaralanmaları <ul style="list-style-type: none"><li>▶ Koruyucu eldiven kullanılmalıdır.</li></ul>
---	--

	<b>DİKKAT</b> <b>Vidaların gevşetilmesi nedeniyle parçaların düşme tehlikesi!</b> Düşen parçalar nedeniyle yaralanma. <ul style="list-style-type: none"><li>▶ Bileşenleri düşmeye karşı emniyete alın.</li></ul>
--	--

	<b>DİKKAT!</b> <b>Vidaların gevşetilmesi nedeniyle parçaların düşme tehlikesi!</b> Cihazın diğer parçalarında veya müşterinin evinde (örn. zemin) hasarlar. <ul style="list-style-type: none"><li>▶ Bileşenleri düşmeye karşı emniyete alın.</li></ul>
--	--

#### Ön kopul:

- ✓ Cihazın fişi çekilir.
- ✓ Cihaz, su beslemesinden ayrılır.
- ✓ [Üst tabla söküldü.→449](#)
- ✓ [Deterjan bölmesi söküldü.→450](#)

#### 4.4.1 Gösterge panelinin sökülmesi

1. Vidaları sökün (1).
2. Tırnakları (2, 3) serbest bırakın.

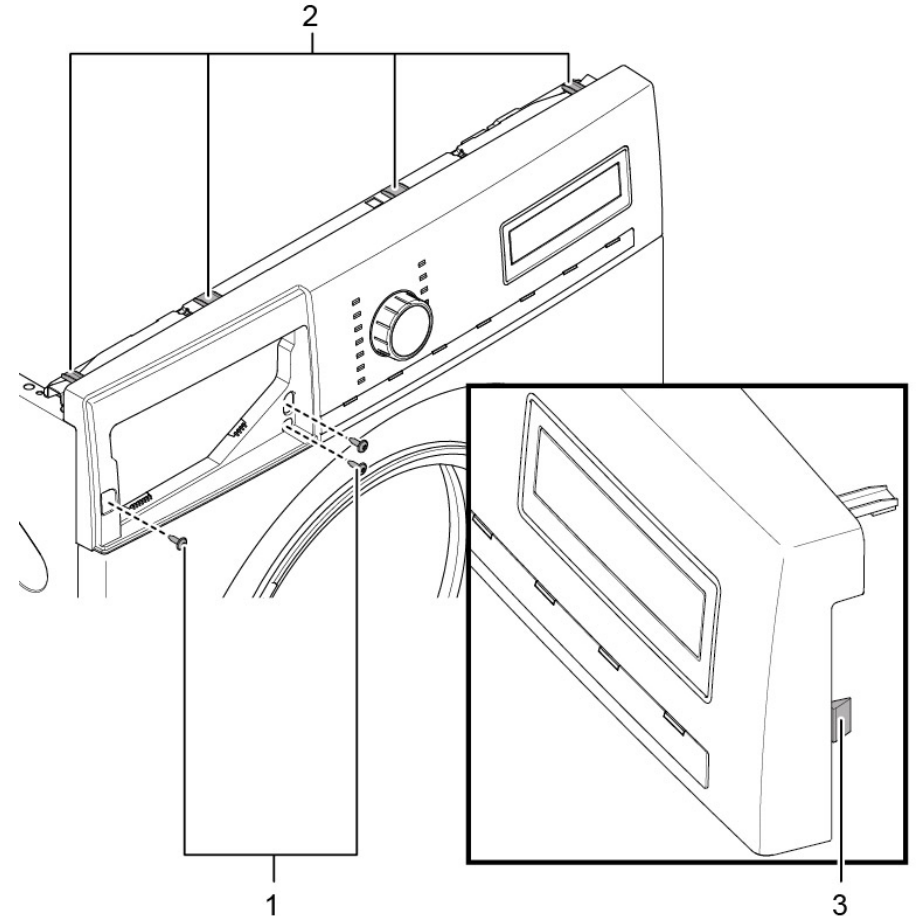

2. Kontrol ünitesinin fiş kontağını serbest bırakın.
3. Gösterge panelini sökün.

### 4.4.2 Gösterge panelinin takılması



Kablo montajını dikkate alın. Kablo sıkışmış olabilir.

- Ters sıra ile monte edin.

## 4.5 Kapının deęiřtirilmesi



### DİKKAT

#### Açık menteře bölgesi!

Parmakların ezilmesi / sıkışması

- ▶ Menteře bölgesine elinizi sokmayın.
- ▶ Koruyucu eldiven kullanılmalıdır.



### DİKKAT

#### Vidaların gevřetilmesi nedeniyle parçaların düşme tehlikesi!

Düşen parçalar nedeniyle yaralanma.

- ▶ Bileşenleri düşmeye karşı emniyete alın.



### DİKKAT!

#### Vidaların gevřetilmesi nedeniyle parçaların düşme tehlikesi!

Cihazın dięer parçalarında veya müşterinin evinde (örn. zemin) hasarlar.

- ▶ Bileşenleri düşmeye karşı emniyete alın.

#### Ön koęul:

- ✓ Cihazın fiři çekilir.
- ✓ Cihaz, su beslemesinden ayrılır.
- ✓ Kapı açık.

### 4.5.1 Kapının sökülmesi

1. Vidaları sökün (1).

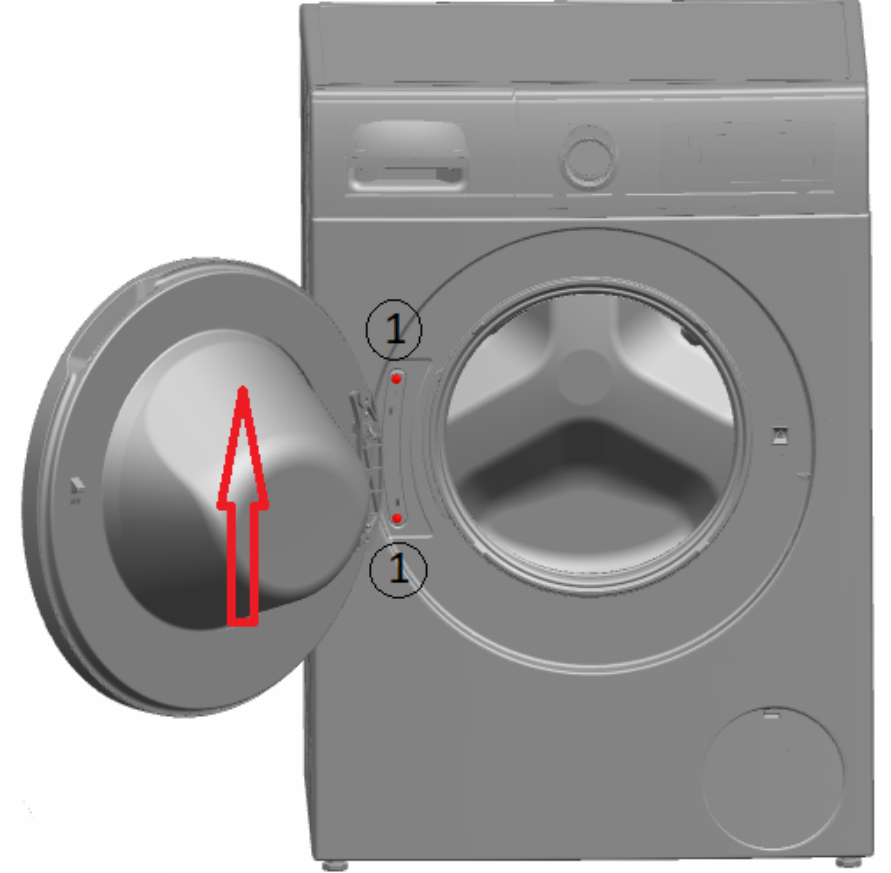



2. Kapıyı yukarıya doęru sökün.

### 4.5.2 Kapının takılması

- ▶ Ters sıra ile monte edin.

## 4.6 Kapı bileşenlerinin değiştirilmesi

	<p><b>UYARI</b></p> <p><b>Ağır ve hareketli bileşenler!</b> Onarım, bakım, hata arama ve servis çalışmaları sırasında ezilme tehlikesi</p> <ul style="list-style-type: none"><li>▶ Koruyucu ayakkabı giyin.</li><li>▶ Yere düşmemesi için ağır parçaları emniyete alın.</li><li>▶ Hareketli parçaların arasına gövde parçaları koymayın.</li></ul>
	<p><b>DİKKAT</b></p> <p><b>Açık menteşe bölgesi!</b> Parmakların ezilmesi / sıkışması</p> <ul style="list-style-type: none"><li>▶ Menteşe bölgesine elinizi sokmayın.</li><li>▶ Koruyucu eldiven kullanılmalıdır.</li></ul>

### Ön koşul:

- ✓ Cihazın fişi çekilir.
- ✓ Cihaz, su beslemesinden ayrılır.
- ✓ [Kapı kaldırıldı.→454](#)

### 4.6.1 Kapı bileşenlerinin sökülmesi

- ▶ Kapıyı dıştan içe sökün.

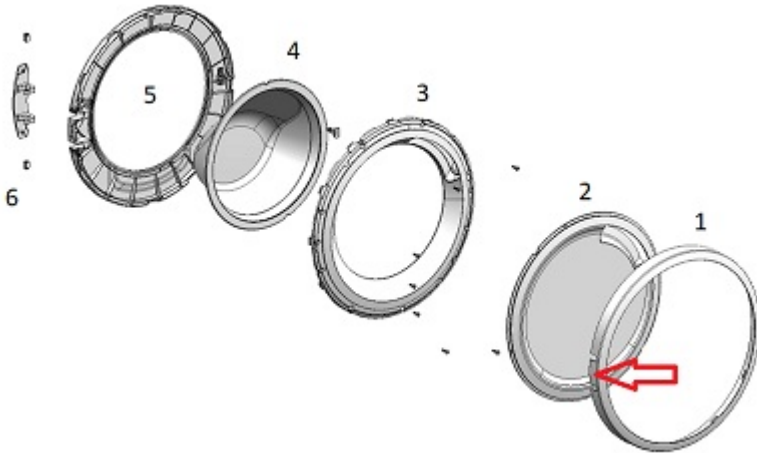

### 4.6.2 Kapı bileşenlerinin takılması

- ▶ Ters sıra ile monte edin.

## 4.7 Pompa kapağının değiştirilmesi

### Ön koşul:

- ✓ Cihazın fişi çekilir.
- ✓ Cihaz, su beslemesinden ayrılır.

### 4.7.1 Pompa kapağının sökülmesi

1. Pompa kapağını açın.

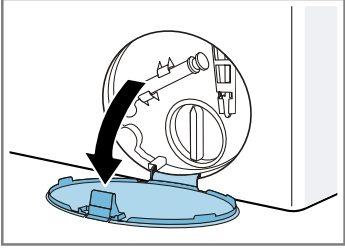

2. Pompa kapağını sökün.

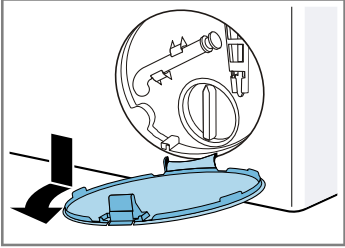



### 4.7.2 Pompa kapağının takılması

- ▶ Ters sıra ile monte edin.

## 4.8 Kapı contasının değiştirilmesi

	<b>⚠ DİKKAT</b> <b>Keskin gövde kenarları!</b> Kesik yaralanmaları ▶ Koruyucu eldiven kullanılmalıdır.
--	---

	<b>⚠ DİKKAT</b> <b>Vidaların gevşetilmesi nedeniyle parçaların düşme tehlikesi!</b> Düşen parçalar nedeniyle yaralanma. ▶ Bileşenleri düşmeye karşı emniyete alın.
--	---

	<b>DİKKAT!</b> <b>Vidaların gevşetilmesi nedeniyle parçaların düşme tehlikesi!</b> Cihazın diğer parçalarında veya müşterinin evinde (örn. zemin) hasarlar. ▶ Bileşenleri düşmeye karşı emniyete alın.
--	---

### Ön koşul:

- ✔ Cihazın fişi çekilir.
- ✔ Cihaz, su beslemesinden ayrılır.
- ✔ Cihaza serbest erişim mümkün.
- ✔ [Üst tabla söküldü.→449](#)
- ✔ [Deterjan bölmesi söküldü.→450](#)
- ✔ [Gösterge paneli söküldü.→452](#)
- ✔ [Kapı kaldırıldı.→454](#)
- ✔ [Pompa kapağı söküldü.→456](#)
- ✔ [Ön panel söküldü.→461](#)
- ✔ [Tambur ışığı söküldü \(opsiyonel\).→460](#)

### 4.8.1 Kapı contasının sökülmesi

1. Tüm hortum bağlantılarını ayırın.

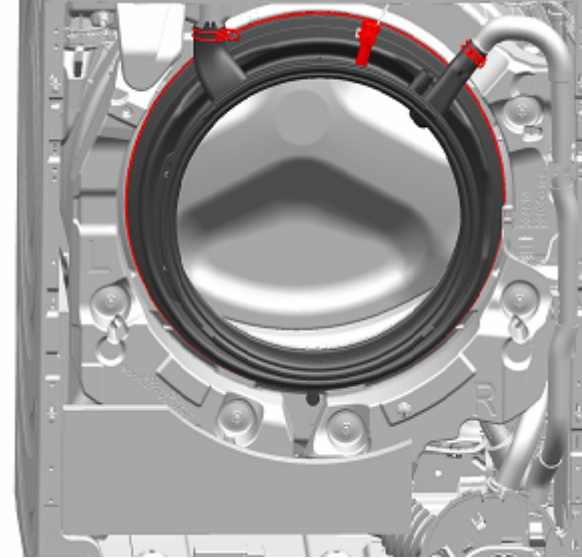

2. Kapı contasını sökün.

### 4.8.2 Kapı contasının takılması

	<b>⚠ UYARI</b> <b>Yanlış montaj nedeniyle parçaların düşmesi tehlikesi!</b> Yaralanma veya cihaz hasarı. ▶ Koruyucu kapak contasının germe halkasını 3,4 Nm ile sıkın.
--	---

- ▶ Ters sıra ile monte edin.

## 4.9 Kapı kilidinin değiştirilmesi

(AB) 2019/2023 Düzenlemesi uyarınca, tüketicilere onarım talimatları ile birlikte yedek bir kapı kilidinin sağlanması üretici olarak bizim yükümlülüğümüzdür. Bununla birlikte, bir kapı kilidi değişimi sonrasında cihaz çalıştırılmadan önce kalifiye bir elektrik uzmanı tarafından mutlaka bir elektroteknik güvenlik testinin gerçekleştirilmesi gerektiğini de vurgulamak isteriz. Bu kişinin ülkeye özgü yasalar, düzenlemeler ve standartlar kapsamındaki hükümlerin gerektirdiği niteliklere sahip olduğu doğrulanabilir olmalıdır.

	<b>TEHLİKE</b> <b>Gerilim ileten parçalar nedeniyle elektrik çarpması tehlikesi!!</b> Onarımın düzgün yapılmaması nedeniyle elektrik çarpması sonucu hayati tehlike <ul style="list-style-type: none"><li>▶ Elektrikli parçaların onarımı kalifiye bir elektrik uzmanı tarafından gerçekleştirilmelidir.</li><li>▶ Onarım sonrasında VDE 0701 veya ülkeye özel düzenlemeler uyarınca bir güvenlik testi gerçekleştirilmelidir.</li></ul>
--	--

	<b>UYARI</b> <b>Eğilmiş cihazların kayması!</b> Kemik kırılmaları / çarpma sonucu yaralanmalar <ul style="list-style-type: none"><li>▶ Cihazları kaymaya karşı emniyete alın.</li></ul>
--	---

	<b>DİKKAT</b> <b>Keskin gövde kenarları!</b> Kesik yaralanmaları <ul style="list-style-type: none"><li>▶ Koruyucu eldiven kullanılmalıdır.</li></ul>
---	--

	<b>DİKKAT</b> <b>Vidaların gevşetilmesi nedeniyle parçaların düşme tehlikesi!</b> Düşen parçalar nedeniyle yaralanma. <ul style="list-style-type: none"><li>▶ Bileşenleri düşmeye karşı emniyete alın.</li></ul>
--	--

	<b>DİKKAT!</b> <b>Vidaların gevşetilmesi nedeniyle parçaların düşme tehlikesi!</b> Cihazın diğer parçalarında veya müşterinin evinde (örn. zemin) hasarlar. <ul style="list-style-type: none"><li>▶ Bileşenleri düşmeye karşı emniyete alın.</li></ul>
--	--

### Ön kopul:

- ✓ Cihazın fişi çekilir.

- ✓ Cihaz, su beslemesinden ayrılır.
- ✓ Cihaza serbest erişim mümkün.
- ✓ [Üst tabla söküldü.→449](#)
- ✓ [Deterjan bölmesi söküldü.→450](#)
- ✓ [Gösterge paneli söküldü.→452](#)
- ✓ [Kapı kaldırıldı.→454](#)
- ✓ Geri halkası söküldü.
- ✓ [Kapı contası söküldü.→457](#)
- ✓ [Pompa kapağı söküldü.→456](#)
- ✓ [Ön panel söküldü.→461](#)

### 4.9.1 Kapı kilidinin sökülmesi

1. Kapı kilidi fişini ayırın.
2. Kapı kilidini serbest bırakın.



3. Kapı kilidini sökün.

#### 4.9.2 Kapı kilidinin monte edilmesi

Cihazın acil durum kapısının açılma işlevinin sağlanması için kapı kilidi sağ konumda olmalıdır.

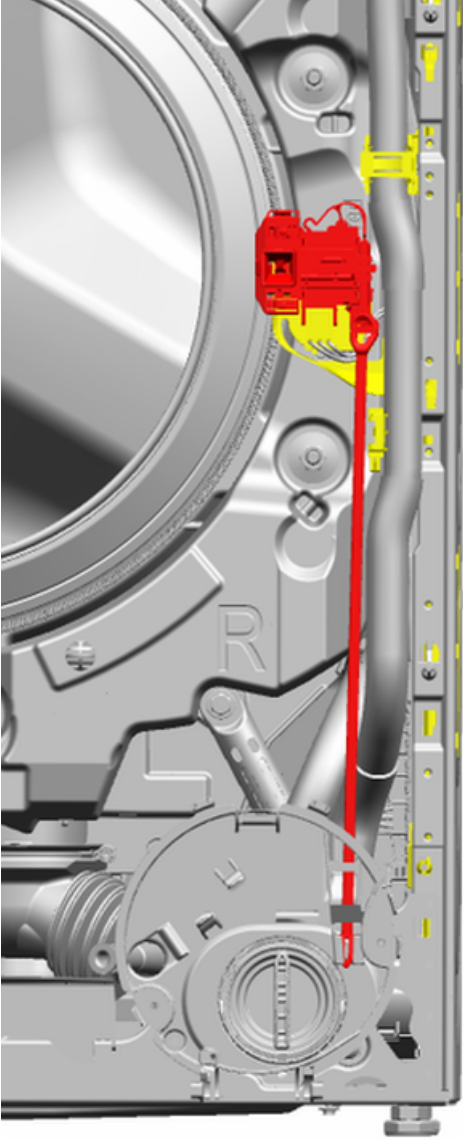

- Ters sıra ile monte edin.

## 4.10 Tambur lambasının deęiřtirilmesi



### UYARI

#### Eęilmiř cihazların kayması!

- Kemik kırılmaları / arpma sonucu yaralanmalar
- ▶ Cihazları kaymaya karřı emniyete alın.



### DİKKAT

#### Keskin gövde kenarları!

- Kesik yaralanmaları
- ▶ Koruyucu eldiven kullanılmalıdır.



### DİKKAT

#### Vidaların gevřetilmesi nedeniyle paraların dūřme tehlikesi!

- Dūřen paralar nedeniyle yaralanma.
- ▶ Bileřenleri dūřmeye karřı emniyete alın.



### DİKKAT!

#### Vidaların gevřetilmesi nedeniyle paraların dūřme tehlikesi!

- Cihazın dięer paralarında veya mūřterinin evinde (örn. zemin) hasarlar.
- ▶ Bileřenleri dūřmeye karřı emniyete alın.

#### Ön koęul:

- ✓ Cihazın fiři ekilir.
- ✓ Cihaz, su beslemesinden ayrılır.
- ✓ Cihaza serbest eriřim mūmkün.
- ✓ [Üst tabla sōkūldü.→449](#)
- ✓ [Deterjan bölmesi sōkūldü.→450](#)
- ✓ [Gösterge paneli sōkūldü.→452](#)

## 4.10.1 Tambur lambasının sōkülmesi

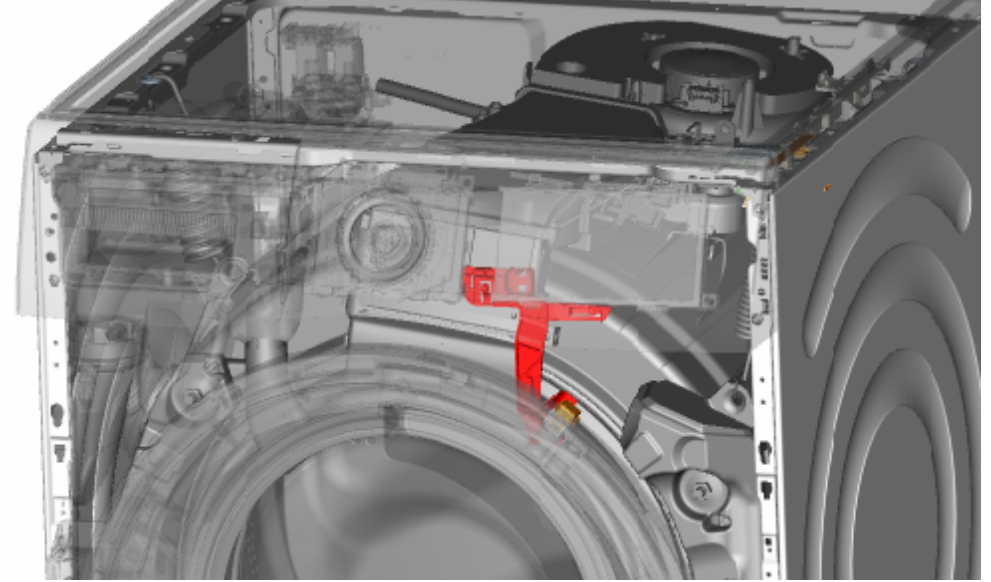

1. Tambur lambası tutucusunu cihazdan dıřarı ekin.
2. Elektrik baęlantısını sōkün.
3. Tambur lambasını tambur lambası tutucusundan sōkün.

## 4.10.2 Tambur lambasının takılması



Kablo montajını dikkate alın. Kablo sıkıřmıř olabilir.

- ▶ Ters sıra ile monte edin.

## 4.11 Ön panelin değişimi



### UYARI

#### Eğilmiş cihazların kayması!

- Kemik kırılmaları / çarpma sonucu yaralanmalar
- ▶ Cihazları kaymaya karşı emniyete alın.



### DİKKAT

#### Keskin gövde kenarları!

- Kesik yaralanmaları
- ▶ Koruyucu eldiven kullanılmalıdır.



### DİKKAT

#### Vidaların gevşetilmesi nedeniyle parçaların düşme tehlikesi!

- Düşen parçalar nedeniyle yaralanma.
- ▶ Bileşenleri düşmeye karşı emniyete alın.



### DİKKAT!

#### Vidaların gevşetilmesi nedeniyle parçaların düşme tehlikesi!

- Cihazın diğer parçalarında veya müşterinin evinde (örn. zemin) hasarlar.
- ▶ Bileşenleri düşmeye karşı emniyete alın.

#### Ön koşul:

- ✓ Cihazın fişi çekilir.
- ✓ Cihaz, su beslemesinden ayrılır.
- ✓ Cihaza serbest erişim mümkün.
- ✓ [Üst tabla söküldü.](#)→449
- ✓ [Deterjan bölmesi söküldü.](#)→450
- ✓ [Gösterge paneli söküldü.](#)→452
- ✓ [Kapı kaldırıldı.](#)→454
- ✓ [Pompa kapağı söküldü.](#)→456
- ✓ Geri halkası söküldü.
- ✓ Kapı contası önde çözülmüş durumda.
- ✓ [Tambur ışığı söküldü \(opsiyonel\).](#)→460

### 4.11.1 Ön panelin sökülmesi

1. Cihazı önden kaldırın.

2. Alt taraftaki vidaları sökün (1).

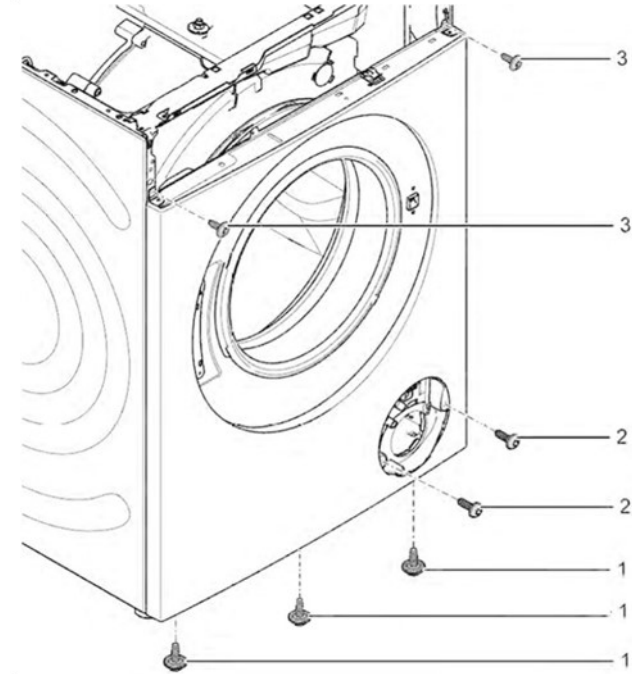

3. Cihazı indirin.

4. Ön taraftaki vidaları, alttan üste doğru sökün (2, 3).

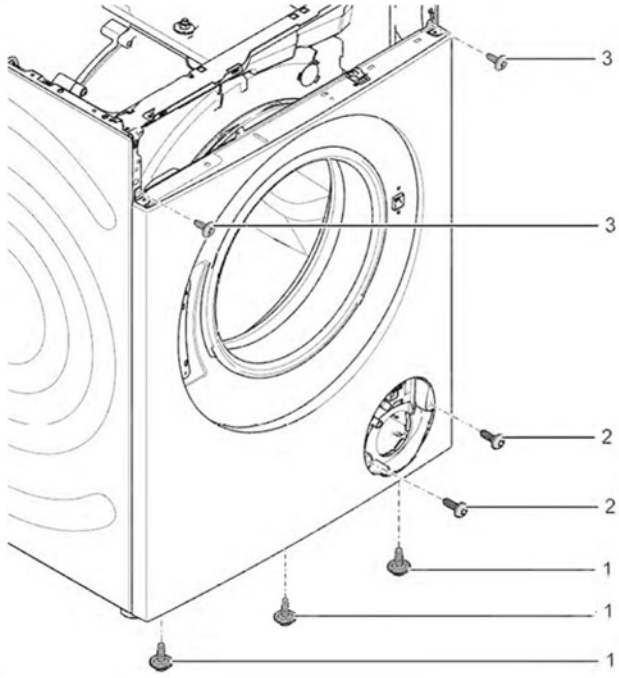

5. Ön paneli sökün.

#### 4.11.2 Ön sacın takılması

- Ters sıra ile monte edin.