

GRUNDIG

Washing Machine

User Manual



GWN69P432



1 General safety instructions

This section contains safety instructions that will help protect from risk of personal injury or property damage. Failure to follow these instructions shall void any warranty.

1.1 Life and property safety

- ▶ Never place the product on a carpet-covered floor. Otherwise, lack of airflow beneath the machine will cause electrical parts to overheat. This will cause problems with your product.
- ▶ Unplug the product if it is not in use.
- ▶ Always have the installation and repairing procedures carried out by the Authorised Service Agent. The manufacturer shall not be held liable for damages that may arise from procedures carried out by unauthorised persons.
- ▶ The water supply and draining hoses must be securely fastened and remain undamaged. Otherwise, there is the risk of water leakage.
- ▶ While there is still water inside the product, never open the loading door or remove the filter. Otherwise, risk of flooding and injury from hot water will occur.
- ▶ Do not force open the locked loading door. The door will open immediately after the washing cycle has ended. If the door does not open, apply the solutions provided for "Loading door cannot be opened." error in the Troubleshooting section. In case of forcing the loading door to open, the door and the lock mechanism may get damaged.
- ▶ Use detergents, softeners and supplements suitable for automatic washing machines only.
- ▶ Follow the instructions on the label of textile products and the detergent package.
- ▶ The water supply pressure required to run the product is between 1 to 10 bars (0.1 – 1 MPa).
- ▶ Do not use old or used water inlet hoses on the new product. It may cause stains on your laundry.

1.2 Children's safety

- ▶ This product can be used by children at and above 8 years old and by persons whose physical, sensory or mental capabilities were not fully developed or who lack experience and knowledge provided that they are supervised or trained on the safe usage of the product and the risks it brings out. Children should not play with the product. Cleaning and maintenance works should not be performed by children unless they are supervised by someone. Children under the age of 3 should be kept away unless continuously supervised.

- ▶ Packaging materials are dangerous for the children. Keep packaging materials in a safe place away from reach of the children.
- ▶ Electrical products are dangerous for the children. Keep children away from the product when it is in use. Do not allow them to play with the product. Use child lock to prevent children from intervening with the product.
- ▶ Do not forget to close the loading door when leaving the room where the product is located.
- ▶ Store all detergents and additives in a safe place away from the reach of the children by closing the cover of the detergent container or sealing the detergent package.

1.3 Electrical safety

- ▶ If the product has a failure, it should not be operated unless it is repaired by the Authorised Service Agent! There is the risk of electric shock!
- ▶ This product is designed to resume operating in the event of powering on after a power interruption. If you wish to cancel the programme, see "Cancelling the programme" section.
- ▶ Plug the product into a grounded outlet protected by a 16 A fuse. Do not neglect to have the grounding installation made by a qualified electrician. Our company shall not be liable for any damages that will arise when the product is used without grounding in accordance with the local regulations.
- ▶ Do not wash the product by spraying or pouring water onto it! There is the risk of electric shock!
- ▶ Never touch the power cable plug with wet hands! Never unplug by pulling on the cable. Always press on the plug with one hand and pull out the plug by grabbing with the other hand.
- ▶ Product should be unplugged during installation, maintenance, cleaning and repair procedures.
- ▶ If the power cable is damaged, it must be replaced by the manufacturer, authorised service or a similarly qualified person (preferably an electrician) or someone designated by the importer in order to avoid possible risks.

1.4 Hot surface safety

	<p>The glass of the loading door gets too hot while washing at higher temperatures. Therefore, especially do not allow children touch the loading door glass while washing.</p>
---	---

2 Important instructions for environment

2.1 Compliance with WEEE Directive

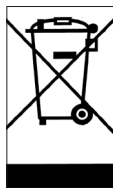

This product complies with EU WEEE Directive (2012/19/EU). This product bears a classification symbol for waste electrical and electronic equipment (WEEE).

This product has been manufactured with high quality parts and materials which can be reused and are suitable for recycling. Do not dispose of the waste product with normal domestic and other wastes at the end of its service life. Take it to the collection center for the recycling of electrical and electronic equipment. Please consult your local authorities to learn about these collection centers.

Compliance with RoHS Directive:

The product you have purchased complies with EU RoHS Directive (2011/65/EU). It does not contain harmful and prohibited materials specified in the Directive.

2.2 Package information

Packaging materials of the product are manufactured from recyclable materials in accordance with our National Environment Regulations. Do not dispose of the packaging materials together with the domestic or other wastes. Take them to the packaging material collection points designated by the local authorities.

3 Intended use

- This product has been designed for domestic use. It is not for commercial purposes or it should not be used out of its intended use.
- The product must only be used for washing and rinsing of laundry that are marked accordingly.
- The manufacturer waives any responsibility arisen from incorrect usage or transportation.
- The service life of your product is 10 years. During this period, original spare parts will be available to operate the appliance properly.
- This appliance is intended to be used in household and similar applications such as:
 - staff kitchen areas in shops, offices and other working environments;
 - farm houses;
 - by clients in hotels, motels and other residential type environments;
 - bed and breakfast type environments;
 - areas for communal use in blocks of flats or in launderettes.

4 Technical specifications

Supplier name or trademark	GRUNDIG
Model name	GWN69P432
	7157644400
Rated capacity (kg)	9
Maximum spin speed (rpm)	1400
Built-in	No
Height (cm)	84
Width (cm)	60
Depth (cm)	64
Single Water inlet / Double Water inlet	• / -
• Available	
Electrical input (V/Hz)	230 V / 50Hz
Total current (A)	10
Total power (W)	2200
Main model code	128





SUPPLIER'S NAME MODEL IDENTIFIER → (*)









































The model information as stored in the product database can be reached by entering following website and searching for your model identifier (*) found on energy label.

<https://eprel.ec.europa.eu/>



WARNING: Consumption values are applicable for cases where the wireless network connection is off.

Symbols Table

4.1 Installation

- Apply to the nearest authorised service agent for the installation of your product.
- Preparation of the location and electrical, tap water and waste water installations at the place of installation is under customer's responsibility.
- Make sure that the water inlet and discharge hoses as well as the power cable are not folded, pinched or crushed while pushing the product into its place after installation or cleaning procedures.
- Make sure that the installation and electrical connections of the product are performed by authorised service. Manufacturer shall not be held liable for damages that may arise from procedures carried out by unauthorised persons.
- Prior to installation, visually check if the product has any defects on it. If so, do not have it installed. Damaged products cause risks for your safety.

4.1.1 Appropriate installation location

- Place the product on a hard and level floor. Do not put it onto a carpet with high pile or other similar surfaces.
- When the washing machine and dryer are placed on top of each other, their total weight –when loaded– amounts to 180 kilograms. Place the product on a solid and flat floor that has sufficient load carrying capacity!
- Do not place the product on the power cable.
- Do not install the product in the environments where the temperature falls below 0 °C.
- Leaving a gap at the sides of the machine is suggested to reduce vibration and noise
- On a graduated floor, do not place the product next to the edge or on a platform.
- Do not place heat sources such as Hobs, Irons, Ovens, etc. on the washing machine and do not use them on the product.

4.1.2 Removing packaging reinforcement (If the product has)



Tilt the machine backwards to remove the packaging reinforcement.
Remove the packaging reinforcement by pulling the ribbon. Do not make this operation alone by yourself.

4.1.3 Removing the transportation locks

- 1 Loosen all bolts with an appropriate wrench until they turn freely.
- 2 Remove the transport safety bolts by turning them slightly.
- 3 Insert the plastic covers in the bag containing the user manual to the openings on the rear panel.

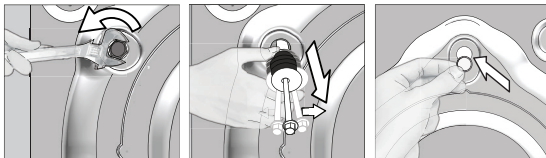

CAUTION: Remove the transportation safety bolts before operating the washing machine! Otherwise, the product will be damaged.



Keep the transportation safety bolts in a safe place to reuse when the washing machine needs to be moved again in the future.

Install the transport safety bolts in reverse order of the disassembly procedure.

Never move the product without the transportation safety bolts properly fixed in place!

4.1.4 Connecting water supply



It is necessary to have 10 – 80 liters of water flowing from the fully open tap in one minute to have your machine run smoothly. Attach a pressure reducing valve if water pressure is higher.



CAUTION: Models with a single water inlet should not be connected to the hot water tap. In such a case the laundry will get damaged or the product will switch to protection mode and will not operate.

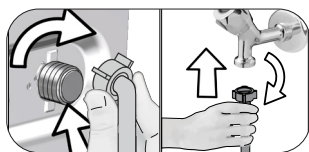

- 1 Tighten the nuts of the hose by hand. Never use a tool when tightening the nuts.
- 2 When hose connection is completed, check whether there is leak problems at the connection points by opening the taps fully. If any leaks occur, turn off the tap and remove the nut. Retighten the nut carefully after checking the seal. In order to prevent the water leaks and resultant damages, keep the taps closed when you do not use the product.

4.1.5 Connecting the drain hose to the drain

- Attach the end of the drain hose directly to waste water drain, lavatory or bathtub.



CAUTION: Your drain house will be flooded if the hose comes out of its housing during water discharge. Moreover, there is risk of scalding due to high washing temperatures! In order to prevent such situations and make sure that the machine performs water intake and discharge processes without any problem, fix the drain hose securely.

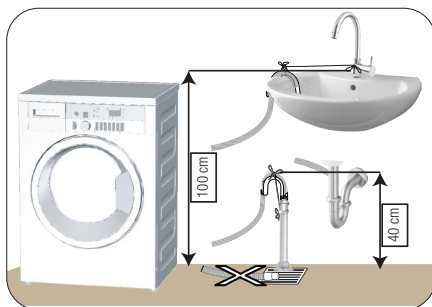

- Connect the drain hose to a minimum height of 40 cm and a maximum height of 100 cm.
- In case the drain hose is elevated after laying it on the floor level or close to the ground (less than 40 cm above the ground), water discharge becomes more difficult and the laundry may come out excessively wet. Therefore, follow the heights described in the figure.

- To prevent the waste water to go back into the machine again and to ensure easy drainage, do not immerse the end of the hose into the waste water or do not insert it into the drain for more than 15 cm. If it is too long, cut it short.
- The end of the hose should not be bent, it should not be stepped on and the hose must not be pinched between the drain and the machine.
- If the length of the hose is too short, use it by adding an original extension hose. Length of the hose may not be longer than 3.2 m. To avoid water leak failures, the connection between the extension hose and the drain hose of the product must be fitted well with an appropriate clamp as not to come off and leak.

4.1.6 Adjusting the feet



CAUTION: In order to ensure that the product operates more silently and vibration-free, it must stand level and balanced on its feet. Balance the machine by adjusting the feet. Otherwise, the product may move from its place and cause crushing and vibration problems.

CAUTION: Do not use any tools to loosen the lock nuts. Otherwise, they will get damaged.

- 1 Loosen the lock nuts on the feet by hand.
- 2 Adjust the feet until the product stands in a stable and balanced way.
3. Tighten all lock nuts by hand again.

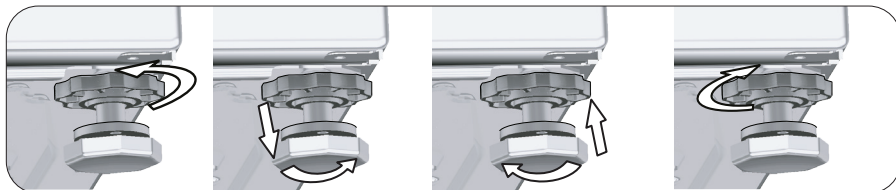

4.1.7 Electrical connection

Connect the product to a grounded outlet protected by a 16 A fuse. The Manufacturer shall not be liable for any damages that will arise when the product is used without grounding in accordance with the local regulations.

- Connection must comply with national regulations.
- The wiring for the electrical outlet circuit must be sufficient to meet the appliance requirements. Use of a Ground Fault Circuit Interrupter (GFCI) is recommended.
- Power cable plug must be within easy reach after installation.
- If the current value of the fuse or breaker in the house is less than 16 Amps, have a qualified electrician install a 16 Amp fuse.
- The voltage specified in the "Technical specifications" section must be equal to your mains voltage.
- Do not make connections via extension cables or multi-plugs.



CAUTION: Damaged power cables must be replaced by the Authorised Service Agents.

4.1.8 Initial use



Before starting to use the product make sure that the preparations are made which are in line with the "Important Safety and Environment Instructions" and the instructions in the "Installation" section.

To prepare the product for washing laundry, perform first operation in Drum Cleaning programme. If this program is not available in your machine, apply the method which is described in the section 4.4.2.



Use an anti-limescale suitable for the washing machines.

Some water might have remained in the product due to the quality control processes in the production. It is not harmful for the product.

4.2 Preparation

4.2.1 Sorting the laundry

- Sort laundry according to type of fabric, colour, and degree of soiling and allowable water temperature.
- Always observe the instructions given on the garment care labels.

4.2.2 Preparing laundry for washing

- Laundry items with metal attachments such as, underwiring, belt buckles or metal buttons will damage the machine. Remove the metal pieces or wash such clothes by putting them in a laundry bag or pillow case.
- Take out all substances in the pockets such as coins, pens and paper clips, and turn pockets inside out and brush. Such objects may damage the product or cause noise problem.
- Put small size clothes such as infant's socks and nylon stockings in a laundry bag or pillow case.
- Place curtains in without compressing them. Remove curtain attachment items.
- Fasten zippers, sew loose buttons and mend rips and tears.
- Wash "Machine washable" or "Hand washable" labelled products only with an appropriate programme.
- Do not wash colours and whites together. New, dark coloured cottons release a lot of dye. Wash them separately.
- Tough stains must be treated properly before washing.
- Only use the dyes / colour changers and descaling agents which are appropriate for machine wash. Always follow the instructions on the package.
- Wash trousers and delicate laundry turned inside out.
- Keep laundry items made of Angora wool in a plastic bag in the freezer for a few hours before washing. This can reduce piling.
- Laundry that are subjected to materials such as flour, lime dust, milk powder, etc. intensely must be shaken off before placing into the product. Such dusts and powders on the laundry may build up on the inner parts of the product in time and can cause damage.

4.2.3 Tips for energy and water saving

Following information will help you use the product in an ecological and energy/water-efficient manner.

- Operate the product in the highest load capacity allowed for the programme you have selected, but do not overload. See, "Programme and consumption table".
- Observe the temperature instructions on the detergent packaging.
- Wash slightly soiled laundry at low temperatures.
- Use faster programmes for small quantities of lightly soiled laundry.
- Do not use prewash and high temperatures for laundry that is not heavily soiled or stained.
- If you plan to dry your laundry in a dryer, select the highest spin speed recommended during washing process.
- Do not use more detergent than the recommended on the detergent packaging.

4.2.4 Loading the laundry

1. Open the loading door.
2. Put the laundry items into the product in a loose manner.
3. Push the loading door to close until you hear a locking sound. Ensure that no items are caught in the door. The loading door is locked while a programme is running. The door lock will open immediately after the washing programme has ended. Then you can open the loading door. If the door does not open, apply the solutions provided for "Loading door cannot be opened." error in the Troubleshooting section.

4.2.5 Correct load capacity

The maximum load capacity depends on the type of laundry, the degree of soiling and the desired washing programme.

The machine automatically adjusts the water amount according to the weight of the laundry put inside it.



WARNING: Comply with the information in the section "Programme and consumption table". When overloaded, product's washing performance will drop. Moreover, noise and vibration problems may occur.

4.2.6 Using detergent and softener



When using detergent, softener, starch, fabric dye, bleach and descaling agents; read the manufacturer's instructions written on the package and follow the dosages specified. Use measuring cup if available.

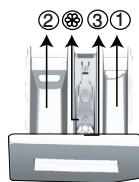

The detergent drawer is composed of three compartments:

- (1) for prewash
- (2) for main wash
- (3) for softener
- (⊗) in addition, there is a siphon piece in the softener compartment.

Detergent, softener and other cleaning agents

- Add detergent and softener before starting the washing programme.
- While the washing cycle is in progress, do not leave the detergent drawer open!
- When using a programme without prewash, do not put any detergent into the prewash compartment (compartment no. "1").
- In a programme with prewash, do not put liquid detergent into the prewash compartment (compartment no. "1").
- Do not select a programme with prewash if you are using a detergent bag or dispensing ball. Place the detergent bag or the dispensing ball directly among the laundry in the product.
- If you are using liquid detergent, do not forget to place the liquid detergent container into the main wash compartment (compartment no. "2").

Choosing the detergent type

Detergent type to be used depends on the washing programme, fabric type and colour.

- Use different detergents for coloured and white laundry.
- Wash your delicate clothes only with special detergents (liquid detergent, wool shampoo, etc.) intended solely for delicate clothes and at suggested programmes.
- When washing dark coloured clothes and quilts, it is recommended to use liquid detergent.
- Wash woollens at suggested programme with special detergent made specifically for woollens
- Please review the programme descriptions part for suggested programme for different textiles.
- All recommendations about detergents are valid for selectable temperature range of programmes.



WARNING: Use only detergents manufactured specifically for washing machines.

WARNING: Do not use soap powder.

Adjusting detergent amount

The amount of washing detergent to be used depends on the amount of laundry, the degree of soiling and water hardness.

- Do not use amounts exceeding the dosage quantities recommended on the detergent package to avoid problems of excessive foam, poor rinsing, financial savings and finally, environmental protection.
- Use less detergent for small loads, lightly soiled clothes and short duration programmes, especially in soft water areas.

Using softeners

Pour the softener into the softener compartment of the detergent drawer.

- Do not exceed the (>max<) level sign on the softener compartment.
- If the softener has lost its fluidity, dilute it with water before adding it in the detergent compartment.



WARNING: Do not use liquid detergents or other cleaning products other than fabric softeners produced for washing machines to soften the clothes.

Using liquid detergents

If the product contains a liquid detergent cup:

- Put the liquid detergent container into the compartment no "2".
- If the liquid detergent lost its fluidity, dilute it with water before putting it into the detergent container.

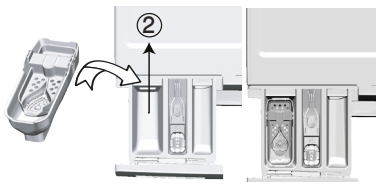

If the product is equipped with a liquid detergent part:

- When you want to use liquid detergent, pull the apparatus towards yourself. The part that falls down will serve as a barrier for the liquid detergent. If required, clean the apparatus with water when it is in place or by removing it. If you will use powder detergent, the apparatus must be secured at top position.

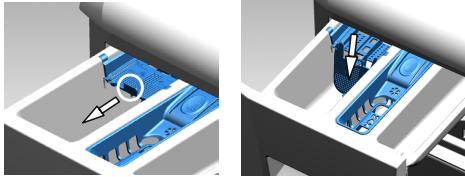

If the product does not contain a liquid detergent cup:

- Do not use liquid detergent for the prewash in a programme with prewash.
- Liquid detergent stains your clothes when used with "End Time" function that delays start time. If you are going to use the End Time function, do not use liquid detergent.

Using gel and tablet detergent

- If the gel detergent thickness is fluidal and your product does not contain a special liquid detergent container, put the gel detergent into the main wash detergent compartment during first water intake. If your product contains a liquid detergent container, fill the detergent into this container before starting the programme.
- If the gel detergent thickness is not fluidal or in the shape of capsule liquid tablet, put it directly into the drum before washing.
- Put tablet detergents into the main wash compartment (compartment no. "2") or directly into the drum before washing.

Using starch

- Add liquid starch, powder starch or the dyestuff into the softener compartment.
- Do not use softener and starch together in a washing cycle.
- Wipe the inside of the product with a damp and clean cloth after using starch.

Using limescale remover

- When required, use limescale removers manufactured specifically for washing machines only.

Using bleaches

- Select a programme with prewash and add the bleach at the beginning of the prewash. Do not put detergent in the prewash compartment. As an alternative application, select a programme with extra rinse and add the bleach while the product is taking water from the detergent compartment during first rinsing step.
- Do not use bleach and detergent by mixing them.
- Use just a little amount (approx. 50 ml) of bleach and rinse the clothes very well as it causes skin irritation.
- Do not pour the bleach onto the laundry.
- Do not use it with the coloured items.
- When using an oxygen-based bleach, select a programme which washes the laundry at a low temperature.
- Oxygen-based bleach can be used together with the detergent. However, if its thickness is not the same with the detergent, put the detergent first into the compartment no. "2" in the detergent drawer and wait until the detergent flows while the product is taking in water. While the product continues taking in water, add bleach in the same compartment.

4.2.7 Tips for efficient washing

		Clothes			
		Light Colours and Whites	Colours	Black/Dark Colours	Delicates/Woolens/Silks
		(Recommended temperature range based on soiling level: 40-90°C)	(Recommended temperature range based on soiling level: cold -40°C)	(Recommended temperature range based on soiling level: cold -40°C)	(Recommended temperature range based on soiling level: cold-30°C)
Soiling Level	Heavily Soiled (difficult stains such as grass, coffee, fruits and blood.)	It may be necessary to pre-treat the stains or perform prewash. Powder and liquid detergents recommended for whites can be used at dosages recommended for heavily soiled clothes. It is recommended to use powder detergents to clean clay and soil stains and the stains that are sensitive to bleaches.	Powder and liquid detergents recommended for colours can be used at dosages recommended for heavily soiled clothes. It is recommended to use powder detergents to clean clay and soil stains and the stains that are sensitive to bleaches. Detergents which do not contain bleach should be used.	Liquid detergents suitable for colours and dark colours can be used at dosages recommended for heavily soiled clothes.	Prefer liquid detergents produced for delicate clothes. Woollen and silk clothes must be washed with special woollen detergents.
	Normally Soiled (For example, stains caused by body on collars and cuffs)	Powder and liquid detergents recommended for whites can be used at dosages recommended for normally soiled clothes.	Powder and liquid detergents recommended for colours can be used at dosages recommended for normally soiled clothes. Detergents which do not contain bleach should be used.	Liquid detergents suitable for colours and dark colours can be used at dosages recommended for normally soiled clothes.	Prefer liquid detergents produced for delicate clothes. Woollen and silk clothes must be washed with special woollen detergents.
	Lightly Soiled (No visible stains exist.)	Powder and liquid detergents recommended for whites can be used at dosages recommended for lightly soiled clothes.	Powder and liquid detergents recommended for colours can be used at dosages recommended for lightly soiled clothes. Detergents which do not contain bleach should be used.	Liquid detergents suitable for colours and dark colours can be used at dosages recommended for lightly soiled clothes.	Prefer liquid detergents produced for delicate clothes. Woollen and silk clothes must be washed with special woollen detergents.

4.2.8 Displayed Programme Time

You can see the programme duration on the display of your machine while selecting a programme.

Depending on the amount of laundry you have loaded into your machine, foaming, unbalanced load conditions, fluctuations in power supply, water pressure and programme settings, the programme duration is automatically adjusted while the programme is running.

SPECIAL CASE: At programme start of Cottons and Cotton Eco programmes, display shows the duration of half load, which is the most common use case. After programme starts, in 20-25 minutes actual load is detected by the machine. And if the detected load is higher than half load; washing programme will be adjusted accordingly and programme duration increased automatically. You may follow this change on the display.

4.3 Operating the product

4.3.1 Control panel

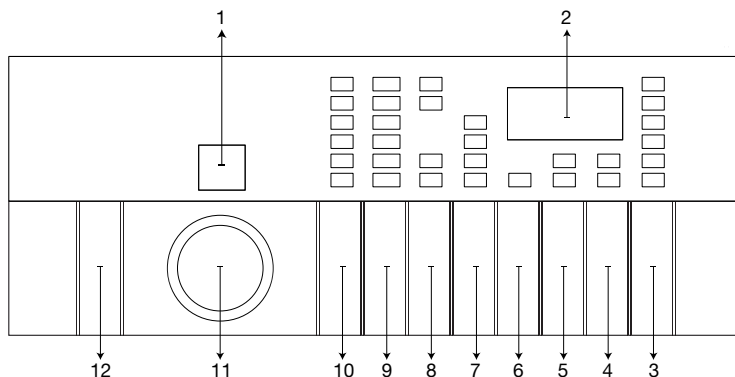

- 1 - Programme selection display
- 2 - Duration information display
- 3 - Start / Pause button
- 4 - Delayed start button
- 5 - Auxiliary function button 4
- 6 - Auxiliary function button 3

- 7 - Auxiliary function button 2
- 8 - Auxiliary function button 1 (Remote control button)
- 9 - Spin speed adjustment button
- 10 - Temperature adjustment button
- 11 - Programme selection knob
- 12 - On/Off button

4.3.2 Display symbols

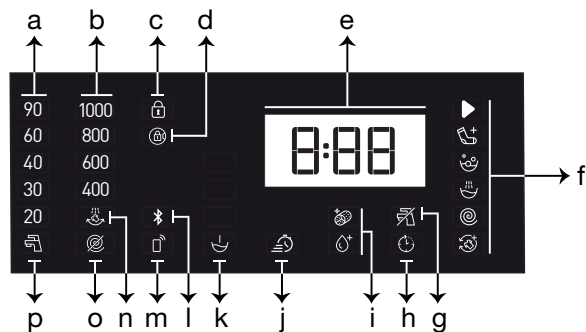

- a- Temperature indicator
- b- Spin speed indicator
- c- Child lock enabled symbol
- d- Door lock is engaged symbol
- e- Duration information
- f- Programme follow-up indicator
- g- No water indicator
- h- Delayed start enabled indicator

- i- Auxiliary function indicators 3
- j- Auxiliary function indicator 2
- k- Auxiliary function indicator 1
- l- Wireless connection indicator
- m- Remote control indicator
- n- Rinse hold indicator
- o- No spin indicator
- p- Cold water indicator



Images used in this section to describe the product are schematic and may not be exactly the same as the actual product.

4.3.3 Programme and consumption table

EN	Programme	Max. Load (kg)	Water Consumption (l)	Energy Consumption (kWh)	Auxiliary functions					Selectable temperature range °C
					Max. Speed	Steam	Fast+	Prewash	Anti-Crease+	
Cotton	90	9	92	2,55	1400	•	•	•	•	Cold-90
	60	9	92	1,80	1400	•	•	•	•	Cold-90
	40	9	90	0,92	1400	•	•	•	•	Cold-90
Eco 40-60	40 ***	9	57,4	0,867	1400					40-60
	40 **,****	4,5	38,0	0,560	1400					40-60
	40 ***	2,5	32,0	0,315	1400					40-60
	60 **	9	57,4	1,100	1400					40-60
	60 **	4,5	40,4	0,820	1400					40-60
Synthetics	60	4	71	1,30	1200	•	•	•	•	Cold-60
	40	4	65	0,80	1200	•	•	•	•	Cold-60
Mini / Mini 14'	90	9	75	1,95	1400	•	•		•	Cold-90
	60	9	75	1,05	1400	•	•		•	Cold-90
	30	9	72	0,15	1400	•	•		•	Cold-90
Mini / Mini 14' + Fast+	30	2	44	0,15	1400	•	•		•	Cold-90
WoolProtect / Hand Wash	40	2	55	0,46	1200					Cold-40
GentleCare	40	4	48	0,75	800					Cold-40
Shirts	60	4	57	1,25	800	•	•	•	•	Cold-60
Lingerie	30	1	74	0,25	600					Cold-30
DarkCare / Jeans	40	4	85	0,95	1200	•	•	•	•	Cold-40
Outdoor / Sport	40	4	50	0,50	1200			•		Cold-40
StainCare	60	4,5	83	1,50	1400		•	•		30-60
Duvet / Down Wear	40	-	85	0,8	1000	•				Cold-60
HygieneCare+	60	9	105	2,25	1400	*				20-90
Drum Clean	90	-	83	2,15	600	*				90
Downloaded Program *****										
Mix	40	4	70	0,85	800	•	•	•	•	Cold-40
Curtain	40	2	85	0,75	800			•		Cold-40
Towel	60	4	95	0,80	1000	•				Cold-60
Soft Toys	40	2	70	0,46	600					Cold-40

• : Selectable.

* : Automatically selected, cannot be cancelled.

** : Eco 40-60 (<40><60>) is the test programme in accordance with EN 60456:2016 and energy label with Commission Delegated Regulation (EU) 1061/2010)

*** : Eco 40-60 with 40 °C temperature selection is the test programme in accordance with EN 60456:2016/prA:2020 and energy label with Commission Delegated Regulation (EU) 2019/2014

***** : These programmes can be used with the HomeWhiz application. Energy consumption may increase with connection.

- : See the programme description for maximum load.



The auxiliary functions in the table may vary according to the model of your machine.

Water and power consumption may vary subject to the changes in water pressure, water hardness and water temperature, ambient temperature, type and amount of laundry, selection of auxiliary functions and spin speed, and changes in the mains voltage.

When selecting a programme, you can see the washing duration on the display of your machine. Depending on the amount of laundry you have loaded into the machine, there might be a difference of 1 to 1.5 hours between the duration shown on the display and the actual duration of the washing programme. The duration will be corrected automatically right after the washing programme has started.

"Auxiliary function selection modes can be changed by the manufacturing company. New selection models may be added, or the existing ones may be removed."

"Spin speed of your machine may vary depending on the programme; the spin speed cannot exceed the maximum spin speed of your machine."

Always select the lowest appropriate temperature. The most efficient programmes in terms of energy consumption are generally those that perform at lower temperatures and longer duration.

Noise and remaining moisture content are influenced by the spinning speed: the higher the spinning speed in the spinning phase, the higher the noise and the lower the remaining moisture content.

Consumption Values (EN)

	Temperature Selection (°C)	Spin Speed (rpm)	Capacity (kg)	Program Duration (h:h:mm)	Energy Consumption (kWh/cycle)	Water Consumption (L/cycle)	Laundry Temperature (°C)	Remaining Moisture Content (%)
Eco 40-60	40	1400	9,0	03:48	0,867	57,40	33	53
	40	1400	4,5	02:53	0,560	38,00	32	53
	40	1400	2,5	02:53	0,315	32,00	24	54
Cotton	20	1400	9	04:00	0,550	90,00	20	53
Cotton	60	1400	9	04:00	1,800	92,00	60	53
Synthetics	40	1200	4	02:35	0,800	65,00	40	40
Mini / Mini 14'	30	1400	9	00:28	0,150	72,00	23	62

4.3.4 Programme selection

- 1 In accordance with the "Programme and consumption table", select a suitable programme for the amount and soiling level of the laundry.



Programmes are limited to the highest spin speed appropriate for that particular type of fabric.

When selecting a programme, always consider the type of fabric, colour, soiling level and permissible water temperature.

- 2 Use the **Programme Selection** knob to select the desired programme.

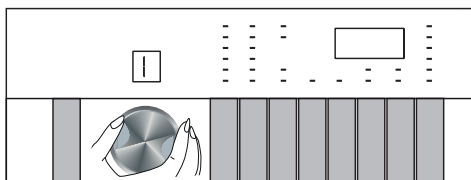

4.3.5 Programmes

• Eco 40-60

The Eco 40-60 programme is able to clean normally soiled cotton laundry declared to be washable at 40 °C or 60 °C, together in the same cycle, and that this programme is used to assess the compliance with the EU ecodesign legislation.

Although it washes longer than all other programmes, it provides high energy and water savings. Actual water temperature may be different from the stated wash temperature. When you load the machine with less laundry (e.g. ½ capacity or less), periods in programme stages may automatically get shorter. In this case, energy and water consumption will decrease.

• Cotton

You can wash your durable cotton laundry (sheets, bedlinen, towels, bathrobes, underwear etc.) in this programme. When you press the quick wash function key, programme duration becomes notably shorter but effective washing is ensured thanks to intense washing movements. If the Quick Wash function is not selected, superior washing and drying performance is ensured for your heavily soiled laundry.

• Synthetics

You can use this programme to wash t-shirts, syntetic/cotton mix fabrics etc. Programme duration is notably shorter and efficient washing performance is ensured. If the quick wash function is not selected, superior washing and rinsing performance is ensured for your heavily soiled laundry.

• WoolProtect / Hand Wash

Use this programme to wash your woolen clothes. Select the appropriate temperature complying with the tag of your clothes. Your laundry will be washed with very delicate movements to avoid any damage.

• HygieneCare+

Applying the steam step at the beginning of the programme ensures that the soils are softened easily. Use this programme for laundry that requires anti-allergic, hygienic and intense washing at a high temperature for a long time, such as infant clothes, bedsheets, bedlinen, underwear and similar cottons. A high level of hygiene is ensured thanks to the steam stem before the programme, long heating and additional rinsing step.

• Programme has been tested by "The British Allergy Foundation - Allergy UK" while the temperature was 60°C, and its efficiency in eliminating bacteria and mould, as well as allergens, was certified.



Allergy UK is the trademark of the British Allergy Foundation. The Seal of Approval has been designed to provide guidance to persons who want information whether the product significantly decreases the amount of allergens in the environment it is installed or whether it limits/reduces/eliminates the allergens. Its purpose is to provide evidence that the products have been tested scientifically or reviewed to provide measurable results.

• Duvet / Down Wear

Use this programme to wash fibre duvets that bear a "Machine-washable" tag. To avoid damaging your machine or duvet, make sure that the duvet is correctly loaded into the machine. Remove the cover of your duvet before loading the machine. Fold the duvet in two before placing it into the machine. Make sure that the duvet does not contact the bellow or glass.

Also use this programme to wash down coats, vests, jackets etc. that bear a "machine-washable" tag.



Do not load the machine with more than a double fibre duvet (200 x 200 cm).

Do not wash your cotton duvets, pillows etc. in the machine.



WARNING: Do not use the washing machine to wash materials other than carpets, rugs etc. Otherwise, permanent damage will occur to the machine.

• Spin+Pump

Use this program to remove the water on the clothe/in the machine.

- **Rinsing**

Use when you want to rinse or starch separately.

- **Curtain**

You can use this programme to wash your tulle and curtains. As their meshed texture causes excessive foaming, put little amount of detergent into the main wash compartment. Thanks to the special spin profile of the programme, tulle and curtains crease less. Do not overload the machine to avoid damage to curtains.



It is recommended to use special detergents produced for curtains in the powder detergent compartment in this programme.

- **Shirts**

Use this programme to wash shirts made of cotton, synthetic and synthetic blended fabrics together. This programme ensures that your clothes wrinkle less. When the quick wash function is selected, the Pre-treatment algorithm is used.

- Apply the pre-treatment chemical directly onto the clothes, or add it together with the detergent to the powder detergent compartment when the machine starts to take in water. This way, it will take you much shorter to get the performance you would normally get with a regular washing cycle. Life of your shirts will be longer.

- **Mini / Mini 14'**

Use this programme to wash your lightly soiled cotton clothes in a short time. The programme duration can be reduced down to 14 minutes when the quick wash function is selected. When the quick wash function is selected, maximum 2 (two) kg of laundry must be washed.

- **DarkCare / Jeans**

Use this programme to preserve the colour of your dark-coloured clothes and jeans. This programme provides high efficiency in washing, thanks to a special drum movement, even at low temperatures. It is recommended to use liquid detergent or woolen shampoo for dark coloured laundry. Do not wash your delicate clothes that contain wool etc. in this programme.

- **Mix**

You can use this programme to wash cottons and synthetics together without the need to sort them.

- **GentleCare**

You can use this programme to wash delicate laundry such as cotton/synthetic mix knitted clothes or socks. Washing movements in this programme are more delicate. Set the temperature to 20 degrees or use the Cold Wash option for clothes whose colour you wish to preserve.

- **Lingerie**

You can use this programme to wash hand-washable delicate clothes or women's underwear. Small amount of laundry must be washed in a laundry bag. Clasps and buttons must be done up, and clothes with zip must be zipped.

- **Outdoor / Sport**

Use this programme to wash outdoor/sports clothes that contain cotton/synthetic mix, as well as waterproof cloths like gore-tex. This programme washes your laundry delicately thanks to its special turning movements.

- **StainCare**

The machine has a special stain programme which enables the removal of different types of stains in the most effective way. Use this programme only for durable colourfast cotton laundry. Do not wash delicate and pigmenting clothes and laundry in this programme. Before washing, garment tags should be checked (recommended for cotton shirts, trousers, shorts, t-shirts, baby clothes, pyjamas, aprons, table clothes, bed sheets, duvet covers, pillowcases, bath-beach towels, towels, socks, cotton underwear that are suitable for washing at high temperature and long time). You can use automatic stain programme to wash 24 types of stains divided into three different groups that can be selected with the "Quick Wash" setting button. Below you can find the soil groups that can be selected with the "Quick Wash" setting button. Depending on the selected stain group, a special washing programme for which duration of rinse hold, washing action, washing and rinsing duration are modified.

Below you can find the soil groups that can be selected with the “Quick Wash” setting button:

When “Quick Wash” is not selected	When the “Quick Wash” button is pressed once	When the “Quick Wash” button is pressed twice
Sweat	Blood	Tea
Collar soil	Chocolate	Coffee
Meal	Pudding	Fruit juice
Mayonnaise	Grass	Ketchup
Salad dressing	Mud	Red wine
Make-up	Egg	Starch
Machine oil	Butter	Jam
Baby food	Curry	Coal

- Select the stain programme.
- In the stain groups stated above, find the type of stain you want to remove and select the quick auxiliary function selection key to select the relevant group.
- Carefully read the tag of the clothing and make sure that the temperature and spin speed selected are suitable.

• Downloaded Program

This is a special programme that allows you to download different programmes when you want to. At the start, there is a programme you will see with the HomeWhiz application as default. However, you can use the HomeWhiz application to select a programme from the predefined programme settings, and then change it.



If you wish to use the HomeWhiz and Remote Control functions, you need to select Download Programme. 4.3.15 Please see the section HomeWhiz and Remote Control Function for more details.

• Soft Toys

Delicate fabrics of soft toys must be washed in the programme for delicates due to the fibre and accessories they contain. Soft Toys programme protects the toys during the washing cycle, thanks to its delicate washing movements and spin profile.. It is recommended to use liquid detergent.



Fragile toys with hard surfaces should not be washed under any circumstances.

Toys should not be washed together with regular laundry since they may harm the clothes.

• Towel

Use this programme to wash durable cotton laundry such as towels. Load the towels into the machine paying attention to place them in a way that they will not contact the bellow or the glass.

4.3.6 Temperature selection

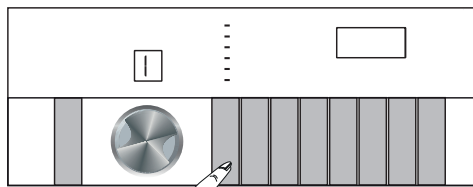

Whenever a new programme is selected, the temperature recommended for that programme appears on the temperature indicator. It is possible that the recommended temperature is not the highest value that can be selected for the relevant programme.

Press the **Temperature Adjustment key** to change the temperature. Temperature will decrease gradually.



No change can be made in programmes where temperature adjustment is not allowed.

You can also change the temperature after the washing cycle has started. This can be done if the washing steps allow it. If they don't permit it, you can't do it.

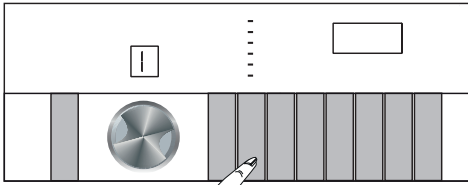

4.3.7 Spin speed selection



Whenever a new programme is selected, the recommended spin speed of the selected programme is displayed on the **Spin Speed** indicator.



It is possible that the recommended spin speed is not the highest value that can be selected for the relevant programme.

Press the **Spin Speed Adjustment key** to change the spin speed. Spin speed decreases gradually. Then, depending on the model of the product, "Rinse Hold"  and "No Spin"  options appear on the display. If you are not going to unload your clothes immediately after the programme ends, you can use the **Rinse Hold** function to keep your laundry in the final rinsing water in order to prevent them from getting wrinkled when there is no water in the machine.

This function holds the laundry in the final rinsing water.

If you want to spin your laundry after the Rinse Hold function:

- Adjust the **Spin Speed**.

- Press **Start/Pause**. Programme will resume. The machine will drain the water and spin the clothes.

If you want to drain the water at the end of the programme without spinning, you can use the **No Spin** function.



No change can be made in programmes where spin speed is not allowed.

If the washing steps permit, you can change the spin speed after the washing cycle has started. If they don't permit it, you can't do it.

Rinse hold

If you are not going to unload your clothes immediately after the programme ends, you can use rinse hold function to keep your laundry in the final rinsing water in order to prevent them from getting wrinkled when there is no water in the machine. After this procedure, if you want to drain the water without spinning your laundry, press Start/Pause. Programme will resume where it left off, drain the water and then it will be complete.

If you want to spin the laundry held in water, adjust the Spin Speed and press Start/Pause. Programme will resume. Water will be drained, laundry will be spun and the programme will end.

4.3.8 Auxiliary function selection

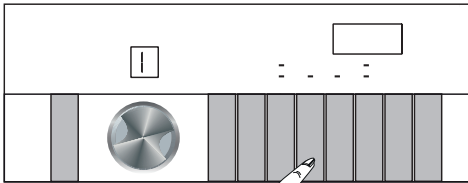

Select the desired auxiliary functions before starting the programme. When a programme is selected, symbols of the auxiliary functions selected with it will turn on.



If you press the key for an auxiliary function that cannot be selected with the current programme, you will hear a warning from the washing machine.

Furthermore, you may also select or cancel auxiliary functions that are suitable for the running programme after the washing cycle starts. If the wash cycle has reached a point where no auxiliary function can be selected, an audible warning will be given.



Some functions cannot be selected together. If a second auxiliary function conflicting with the first one is selected before starting the machine, the function selected first will be canceled and the second auxiliary function selection will remain active.

An auxiliary function which is not compatible with the programme cannot be selected. (See "Programme and consumption table")

Some programmes have auxiliary functions that must be operated with the selected programme. These functions cannot be cancelled.

4.3.8.1. Auxiliary functions

- **Prewash**

A Prewash is required only for heavily soiled laundry. Not using the Prewash will save energy, water, detergent and time.

- **Fast+**

When this function is selected, durations of relevant programmes get shorter by 50%.

Thanks to the optimised washing steps, high mechanic activity and optimum water consumption, high washing performance is achieved in spite of the reduced duration.

- **Steam**

Use this programme to reduce the wrinkles and shorten the ironing times for a small amount of cotton, synthetic or mixed clothes that are not stained.

- **Remote Control** 

You can use this auxiliary function key to connect your product to smart devices. For detailed information, see 4.3.15 HomeWhiz and Remote Control Functions.

- **Specialised Programme**

This auxiliary function can be used for Cottons and Synthetics programmes only with the HomeWhiz application. When this auxiliary function is enabled, you can add up to four additional rinse steps to the programme. You can select and use some auxiliary functions even though they are not found on your product. You can increase and decrease the time of the Cottons and Synthetics programmes within a safe range.



When the Specialised Programme auxiliary function is selected, washing performance and energy consumption will be different than the value indicated.

4.3.8.2 Functions/Programmes Selected by Pressing the Function Keys for Three Seconds

- **Drum Clean**  3"

To select this programme, press and hold the auxiliary function key 4 for three seconds. Use it regularly (every 1-2 months) to clean the drum and ensure the required hygiene is provided. Steam is applied before the programme to soften the residues in the drum. Run the programme while the machine is totally empty. For better results, put powder lime-scale remover for washing machines into the detergent compartment no. "2". When the programme is over, leave the loading door ajar so that the inside of the machine gets dry.



This is not a washing programme. It is a maintenance programme.

Do not run this programme when there are any objects in the machine. If you try to do so, the machine will automatically detect that there is load inside and abort the programme.

When Drum Cleaning+ is selected, the program selection screen of the washing machine will look as it is shown in the following figure. 

- **Anti-Crease+**  3"

If you press and hold the auxiliary function key 2 for three seconds, this function will be selected and the programme follow-up light of the relevant programme will turn on. When this function is selected, the drum will rotate for up to eight hours to ensure that the clothes do not crease at the end of the programme. At any time during these eight hours, you can cancel the programme and unload the machine. Press the function selection key or the machine on/off key to cancel the function. The programme follow-up light will remain on until the function is cancelled or the step is complete. If the function is not cancelled, it will also be enabled in the next washing cycles.

• **Child Lock** 

You can use the Child Lock to prevent children from tampering with the machine. Thus you can avoid any changes in a running programme.

	When the Child Lock is enabled, you can press the On/Off key to switch the machine on or off. When you switch on the product again, programme will resume where it left off, with the child lock enabled.
	If any key pressed while the Child Lock is enabled, an audible warning will be heard and the child lock icon will flash.
	Child lock cannot be selected while the remote control function is enabled.

To enable Child Lock:

Press and hold the auxiliary function key 3 for three seconds. When the countdown **"CL 3-2-1"** on the display ends, **"CL On"** (Child Lock On) icon will be displayed. When this warning is displayed, you can release the **auxiliary function key 3**.

To deactivate Child Lock:

Press and hold the auxiliary function key 3 for three seconds. When the countdown **"CL 3-2-1"** on the display ends, **"CL Off"** (Child Lock off) icon will disappear.

• **Wireless Connection** 

You can use the wireless connection function to pair your machine with your smart device. This way, you can use your smart device to get information about your machine and control it.

To activate wireless connection:

Press and hold the auxiliary function key 1 for three seconds. After the countdown **"3-2-1"** on the display, **"Wireless Connection"** symbol will be displayed. When this warning is displayed, release the **auxiliary function key 1**. The wireless connection icon will flash while the product is connecting to internet. If the connection is successful, the icon's light will remain on.

To deactivate wireless connection:

Press and hold the auxiliary function key 1 for three seconds. After the countdown **"3-2-1"** on the display, **"Wireless Connection"** symbol will disappear.

	For the wireless connection to be enabled, initial setup of the HomeWhiz application must be completed. After the setup, if you press the auxiliary function key 1 while the programme selection knob is in "Download Programme" position, wireless connection will be enabled automatically.
---	---

4.3.9 End Time

Time display

While the programme is running, the time remaining to the end of the programme will be displayed in hours and minutes, e.g. "01:30".

	Programme time may differ from the values in section "Programme and consumption table" depending on the water pressure, water hardness and temperature, ambient temperature, amount and the type of laundry, auxiliary functions selected and the changes in the mains voltage.
---	---

With the **End Time** function, start of the programme can be delayed up to 24 hours. After pressing **End Time** button, the programme's estimated end time will be displayed. If the **End Time** is set, **End Time** indicator will turn on.

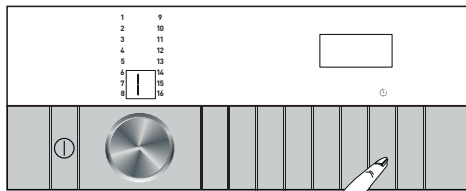

To ensure that the End Time function is enabled and the program ends at the end of the defined duration, you should press **Start/Pause** after setting the duration.

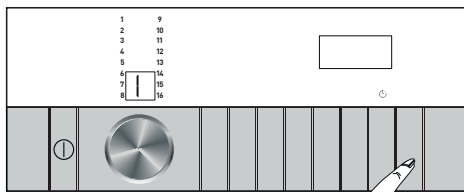

If you want to cancel End Time function, press the **On/Off** button to turn off and on the product.

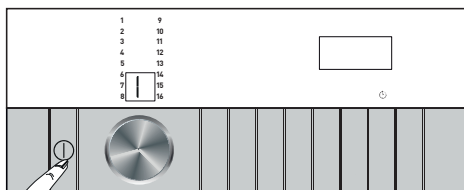

If you enable the End Time function, do not add liquid detergent into the powder detergent compartment 2. Stains might remain on the clothes.

- 1 Open the loading door, place the laundry and put detergent etc.
- 2 Select the washing programme, temperature, spin speed and, if required, the auxiliary functions.
- 3 Press the **End Time** key to set the desired end time. **End Time** indicator will turn on.
- 4 Press **Start/Pause**. Countdown will start. “.” sign in the middle of the end time on the display will start flashing.



During the End Time countdown, you can add laundry into the machine. At the end of the countdown, End Time indicator will turn off, washing cycle will start and the duration of the selected will be displayed.

When End Time is selected, the time shown on the display is the end time selected plus the duration of the programme.

4.3.10 Starting a programme

- 1 Press **Start/Pause** to start a programme.

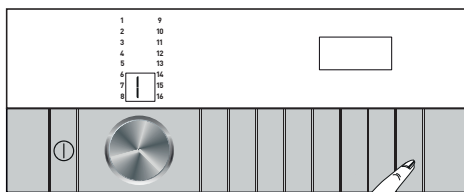

- 3 Loading door will be locked. After the loading door has been locked, door lock symbol will appear on the display.
- 4 The programme follow-up lights on the display show the current programme step.

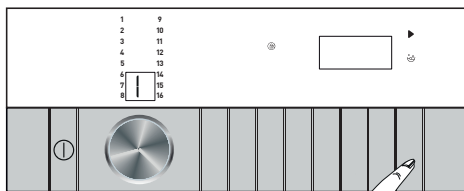

If no programme is started or no key is pressed within 10 minutes during the programme selection process, the product will turn off automatically. Display and all indicators will turn off. If you press the On/Off button, the programme information set as default will be displayed.

4.3.11 Loading door lock

There is a locking system on the loading door of the machine that prevents opening of the loading door in cases when the water level is unsuitable.

"Door Locked" symbol appears on the display when the loading door is locked.



The door will be locked if the Remote Control function is selected. To open the door, you need to press the Remote Control key or change the programme position to deactivate the Remote Control function.

Opening the loading door in case of power failure:



In case of a power failure, you may open the loading door manually using the emergency handle under the pump filter cover.



WARNING: Before opening the loading door, make sure that there is no water in the machine to avoid flooding.

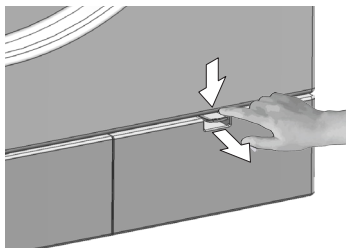

- Turn off and unplug the appliance.
- Open the pump filter cover.

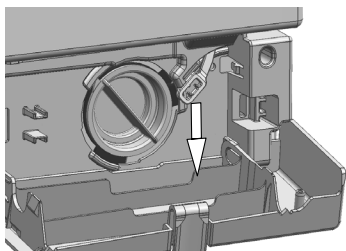

- Remove the loading door emergency handle behind the filter cover with a tool.
- Open the loading door by pulling the loading door emergency handle downwards.
- Try to pull the handle downwards again if the loading door is not opened.
- Bring the loading door emergency handle to its original position after opening the loading door.

4.3.12 Changing the selections after programme has started

Adding laundry after the programme has started

When you press **Start/Pause**, if the condition of the machine is suitable, the laundry adding symbol on the display will turn on, door lock will be disabled and the door will open so that you can add laundry. When the door lock is disabled, the door lock symbol on the display will disappear. After adding the laundry, close the door and press **Start/Pause** again to continue the washing cycle.

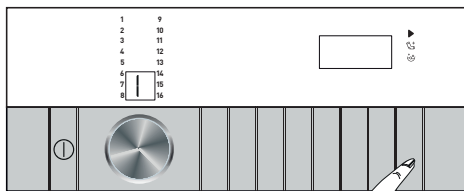

When you press **Start/Pause**, if the water level in the machine is not sufficient, the door lock will not be disabled and the door lock symbol will still be shown on the display.

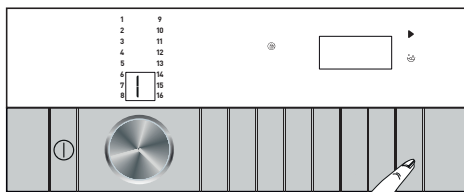

If the temperature of the water inside the machine is above 50°C, you cannot disable the door lock even if the water level is suitable.

Switching the machine to pause mode:

Press **Start/Pause** to switch the machine to the pause mode while a programme is running. Pause symbol will flash on the display.

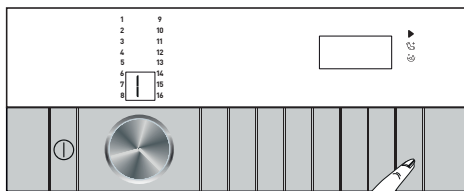

Changing the programme selection after the programme has started:

The programme change is not allowed when the current programme is running. If Child Lock is not enabled, you can select a new programme after switching the current programme to pause mode. This will cancel the current programme.



The selected programme will start anew.

Changing the auxiliary function, speed and temperature

Depending on the step the current programme has reached, you can cancel or enable auxiliary functions. See "Auxiliary function selection"

You can also change the speed and temperature settings. See "Spin speed selection" and "Temperature selection".



If changes are not allowed, an audible warning will be heard.

If the temperature of the water inside the machine is high or if the water level is above the door line, the loading door will not open.

4.3.13 Cancelling the programme

The programme will be cancelled when the machine is turned off and on again. Press and hold the On/Off key for three seconds.

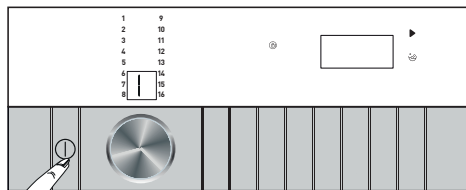

If you press the On/Off key while the child lock is enabled, the programme will not be cancelled. You should cancel the Child Lock first.

If you want to open the loading door after you have cancelled the programme but you cannot do it since the water level in the machine is above the loading door baseline, turn the Programme Selection knob to Spin+Pump programme and discharge the water in the machine.

4.3.14 End of programme

Once the programme is completed, "End" will be displayed.

If you do not press any button for 10 minutes, the product will turn off automatically. Display and all indicators will turn off.

Completed programme steps will be displayed if you press the On/Off button.

4.3.15 Remote Control Function

The Remote Control function allows you to use your smart device to check your washing machine and get information about its status. With the Remote Control, you can use your smart device to do many things that can also be performed on the machine. Plus, you can use some features only with the Remote Control function. You must download the Remote Control application from the app store of your smart device to use the WLAN feature of your machine.

Make sure that your smart device is connected to internet to install the app.

If you are using the app for the first time, please follow the on-screen instructions to complete your user account registration. Once the registration procedure is complete, you can use all products with the Remote Control function in your house on this account.

During setup, Bluetooth must be enabled on your smart device and the device itself must be connected to internet. Your smart device must be near the washing machine. After completing the setup, there is no need for the Bluetooth to be enabled or for your smart device to be near the washing machine. You can use product as long as your smart device is connected to internet.

You can tap "Add/Remove Product" on the "Products" page to see the products paired with your account. You can pair these products on this page.

Once the application is installed, the Remote Control function allows your washing machine to send you push notifications through your smart device.



Please visit www.homewhiz.com to see the Android and iOS versions supported by the HomeWhiz application.

Your washing machine will send you a notification through the HomeWhiz application in the following cases:

- When the programme is over,
- When the door of the washing machine is opened,
- When No water warning is given,
- When a safety warning is given,

	To use the Remote Control function, the app must be installed on your smart device and your washing machine must be connected to your home network. If your washing machine is not connected to the network, it works as an appliance which does not have the Remote Control function.
	You product will operate connected to the wireless network at your home network. The controls carried out by means of the application will be enabled through this network; for this reason, the network coverage around where your appliance is placed must be adequate.
	HomeWhiz supports 2.4 GHz frequency band.

	WARNING: All the safety measures described in " GENERAL SAFETY INSTRUCTIONS " section of the user manual apply to the remote operation through the Remote Control function as well.
	WARNING: You need internet connection to use the Remote Control function. Otherwise, the app will not run on your smart device. Please contact your internet service provider if you are having problems with your internet connection.

4.3.15.1 Installing the Remote Control App

For the application to run, a connection must be established between your product and the application.

	WARNING: You need internet connection to use the Remote Control function. Otherwise, the app will not run on your smart device. Please contact your internet service provider if you are having problems with your internet connection.
---	--

- If you are adding a product for the first time, tap "Add/Remove Product" on the app and touch "Tap here to connect the product to the network". Follow the steps in the app to install it.
- To start the setup, make sure that your washing machine is switched off. Press and hold the On/Off key and the auxiliary function 1 (remote control) key simultaneously for five seconds to set the washing machine to Remote Control setup mode.

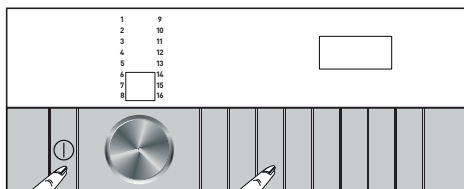

- In the Remote Control setup mode, you will see an animated image on the display and the Wireless icon will flash until your machine connects to internet. In this mode, only the On/Off key will be enabled. Other keys will have no function.

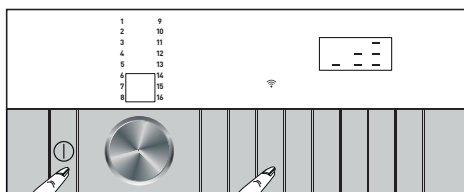

- Tap "Add/Remove Product" on the app, and then tap "Connect new product to the network".
- Follow the on-screen instructions on the Remote Control app.
- When the setup is complete, give your washing machine a name. Now, you can see the product you have just added on the "Products" page.

	If you cannot successfully carry out the setup within 5 minutes, your washing machine will turn off automatically. In this case, you will have to start over the setup procedure. If the problem persists, please contact the authorised service provider.
	You can use your washing machine with more than one smart device. To do this, download the Remote Control app on the other smart device as well. After launching the app, you will need to sign in to your account you have previously created and paired with your washing machine. Otherwise, please read "Setting up a washing machine that is connected to someone else's account".



The Remote Control application may ask you to enter the product number stated on the label of the product. Product label is found on the inner side of the loading door. Product number is written on this label.



4.3.15.2 Setting up a washing machine that is connected to someone else's account

If the washing machine you want to use was registered in the system with someone else's account before, please firstly create a new account and log in to this account on the HomeWhiz application. After you have logged on in the application, you can follow the steps described in the section 4.3.15.1 in order to setup and onboard your device.



Your request to add the product will be sent to the product's owner via e-mail. You can start to use the product mutually once the product's owner has approved your request. Plus, the product owner may accept or reject the request sent through the application. For this, the person must select the Settings tab on the main page of the application. They must proceed to the User Linking Settings page and accept the request, if they want to.

4.3.15.3 Deleting Remote Control Account Linking

To delete the linking of a washing machine that has been paired with someone else's account, follow the steps below.

- Press the On/Off key to turn on your washing machine.
- While your machine is on, press and hold the auxiliary function key 1 and Time Delay key for five seconds.

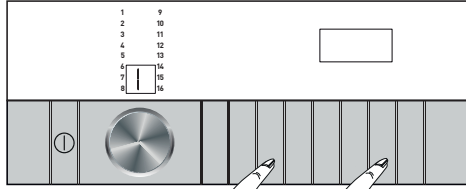

- After countdown "5-4-3-2-1" on the display, you will hear a beep for your request. Deleting the linking will take a few seconds. Once it is complete, you will hear two beeps.



WARNING: Once you have completed this procedure, you cannot use the Remote Control function of your machine until you perform setup again.

WARNING: Your product does not have to be connected to the internet to delete the account linking. Your request will be received. Linking will be automatically deleted as soon as your product connects to internet.

4.3.15.4 Remote Control Function and Its Use

After setting up the Remote Control function, wireless connection will be enabled automatically. To activate or deactivate the wireless connection, please see "4.3.8.2 Wireless Connection".

If you turn off and on your machine while wireless connection is active, it will automatically reconnect. In cases such as network password change or modem turn-off, the wireless connection will be disabled automatically. For this reason, you will need to turn it on again if you want to use the Remote Control function.

You can check the wireless connection symbol on the display to track your connection status. If the symbol is continuously on, you have internet connection. If the symbol is flashing, the product is trying to connect. If the symbol is off, you have no connection.



WARNING: If the wireless network connection is enabled on your product, you can select the Remote Control function. If the Remote Control function cannot be selected, check the connection status. If the connection fails, repeat the initial set-up settings on the appliance.

If you want to control your washing machine remotely, while “Download Programme” is selected on the control panel, press the auxiliary function key 1 to enable the Remote Control function. Once the product is accessed, you will see a screen similar to the one below.

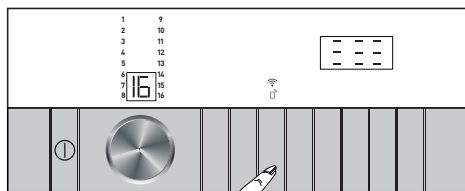

While the Remote Control function is on, you can only manage turn-on, turn-off and status follow-up operations through your washing machine. All functions except child lock can be managed through the application.

You can check the function indicator on the key to follow whether the Remote Control function is On or Off.

If the Remote Control function is Off, all the operations are handled on the washing machine and only status follow-up is allowed on the application.

In the event that the Remote Control function cannot be turned on, the function frame on the button will be off. Wireless settings being Off or the washing machine's door being open are examples for such cases.

Once you activate this function on the washing machine, it will remain enabled apart from certain conditions and allow you to control your washing machine remotely via the internet regardless of whether the washing machine is switched on or off and independently from location.

In certain cases, it deactivates itself for safety reasons:

- When your washing machine undergoes a power interruption
- When the door of the washing machine is opened
- When the On/Off key on the control panel is pressed

4.3.15.5 Troubleshooting

Follow the steps below if you are having problem with controlling or connection. Observe whether the problem persists or not after the action you have performed. Do the following if the problem is not resolved.

- Check whether your smart device is connected to the relevant home network.
- Restart the product application.
- Proceed to the settings menu on the product and switch Wireless Connection: Off to Wireless Connection: On and reconnect via the application.
- If the connection cannot be established with the above processes, repeat the initial set-up settings on the washing machine.

If the problem persists, consult an Authorised Service Agent.

4.4 Maintenance and cleaning

Service life of the product extends and frequently faced problems decrease if cleaned at regular intervals.

4.4.1 Cleaning the detergent drawer

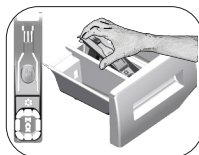

Clean the detergent drawer at regular intervals (every 4-5 washing cycles) as shown below in order to prevent accumulation of powder detergent in time. Lift the rear part of the siphon to remove it as illustrated.

If more than normal amount of water and softener mixture starts to gather in the softener compartment, the siphon must be cleaned.

- 1 Press the dotted point on the siphon in the softener compartment and pull towards you until the compartment is removed from the machine.
- 2 Wash the detergent drawer and the siphon with plenty of lukewarm water in a washbasin. In order to prevent the residues to contact your skin, clean it with an appropriate brush by wearing a pair of gloves.
- 3 Insert the drawer back into its place after cleaning and make sure that it is seated well.

4.4.2 Cleaning the loading door and the drum

For products with drum cleaning programme, please see Operating the product - Programmes.



Repeat Drum Cleaning process in every 2 months.

Use an detergent / anti-limescale suitable for the washing machines.



After every washing make sure that no foreign substance is left in the drum.

If the holes on the bellow shown in the figure is blocked, open the holes using a toothpick.

Foreign metal substances will cause rust stains in the drum. Clean the stains on the drum surface by using cleaning agents for stainless steel.

Never use steel wool or wire wool. These will damage the painted, chromated and plastic surfaces.

4.4.3 Cleaning the body and control panel

Wipe the body of the machine with soapy water or non-corrosive mild gel detergents as necessary, and dry with a soft cloth.

Use only a soft and damp cloth to clean the control panel.

4.4.4 Cleaning the water intake filters

There is a filter at the end of each water intake valve at the rear of the machine and also at the end of each water intake hose where they are connected to the tap. These filters prevent foreign substances and dirt in the water to enter the washing machine. Filters should be cleaned as they do get dirty.

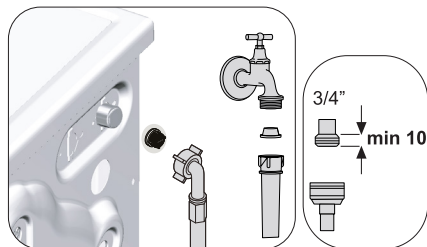

1. Close the taps.
2. Remove the nuts of the water intake hoses to access the filters on the water intake valves. Clean them with an appropriate brush. If the filters are too dirty, remove them from their places with a pliers and clean in this way.
3. Take out the filters on the flat ends of the water intake hoses together with the gaskets and clean thoroughly under running water.
4. Replace the seals and filters carefully and tighten their nuts by hand.

4.4.5 Draining remaining water and cleaning the pump filter

The filter system in your machine prevents solid items such as buttons, coins and fabric fibers clogging the pump impeller during discharge of washing water. Thus, the water will be discharged without any problem and the service life of the pump will extend.

If the machine fails to drain water, the pump filter is clogged. Filter must be cleaned whenever it is clogged or in every 3 months. Water must be drained off first to clean the pump filter.

In addition, prior to transporting the machine (e.g., when moving to another house) and in case of freezing of the water, water may have to be drained completely.



CAUTION: Foreign substances left in the pump filter may damage your machine or may cause noise problem.

CAUTION: If the product is not being used, shut the tap shut, remove mains pipe and drain the water inside the machine against any likely freezing.

CAUTION: After each use, turn off the water tap to which the mains hose is connected.

In order to clean the dirty filter and discharge the water:

1. Unplug the machine to cut off the supply power.



CAUTION: Temperature of the water inside the machine may rise up to 90 °C. To avoid burning risk, filter must be cleaned after the water in the machine cools down.

2. Open the filter cap.



If the filter cap is composed of two pieces, press the tab on the filter cap downwards and pull the piece out towards yourself.

3. Some of our products have emergency draining hose and some does not have. Follow the steps below to discharge the water.

Discharging the water when the product has an emergency draining hose:

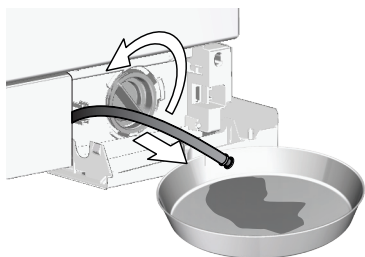

- Pull the emergency draining hose out from its seat
- Place a large container at the end of the hose. Drain the water into the container by pulling out the plug at the end of the hose. When the container is full, block the inlet of the hose by replacing the plug. After the container is emptied, repeat the above procedure to drain the water in the machine completely.
- When draining of water is finished, close the end by the plug again and fix the hose in its place.
- Turn the pump filter to take it out.

4. Clean any residues inside the filter as well as fibers, if any, around the pump impeller region.

5. Install the filter.

6. If the filter cap is composed of two pieces, close the filter cap by pressing on the tab. If it is one piece, seat the tabs in the lower part into their places first, and then press the upper part to close.

5 Troubleshooting

Problem	Cause	Solution
Programs do not start after the loading door is closed.	Start / Pause / Cancel button is not pressed.	<ul style="list-style-type: none"> Press Start / Pause / Cancel button.
	It may be difficult to close the loading door in case of excessive loading.	<ul style="list-style-type: none"> Reduce the amount of laundry and make sure that the loading door is closed properly.
Programme cannot be started or selected.	The product has switched to self protection mode due to a supply problem (line voltage, water pressure, etc.).	<ul style="list-style-type: none"> Press and hold On/Off button for 3 seconds to reset the product to factory settings. (See "Cancelling the programme")
Water inside the product.	Some water has remained in the product due to the quality control processes in the production.	<ul style="list-style-type: none"> This is not a failure; water is not harmful to the product.
The product does not take water in.	Tap is turned off.	<ul style="list-style-type: none"> Turn on the taps.
	Water inlet hose is bent.	<ul style="list-style-type: none"> Flatten the hose.
	Water inlet filter is clogged.	<ul style="list-style-type: none"> Clean the filter.
	Loading door is not closed.	<ul style="list-style-type: none"> Close the door.
The product does not drain water.	Water drain hose is clogged or twisted.	<ul style="list-style-type: none"> Clean or flatten the hose.
	Pump filter is clogged.	<ul style="list-style-type: none"> Clean the pump filter.
Product vibrates or makes noise.	Product is standing unbalanced.	<ul style="list-style-type: none"> Stable the product by adjusting the feet.
	A hard substance has entered into the pump filter.	<ul style="list-style-type: none"> Clean the pump filter.
	Transportation safety bolts are not removed.	<ul style="list-style-type: none"> Remove the transportation safety bolts.
	Laundry quantity in the product is too little.	<ul style="list-style-type: none"> Add more laundry to the product.
	Excessive laundry is loaded in the product.	<ul style="list-style-type: none"> Take out some of the laundry from the product or distribute the load by hand to balance it homogeneously in the product.
There is water leaking from the bottom of the product.	Product is leaning on a rigid item.	<ul style="list-style-type: none"> Make sure that the product is not leaning on anything.
	Water drain hose is clogged or twisted.	<ul style="list-style-type: none"> Clean or flatten the hose.
Product stopped shortly after the programme started.	Pump filter is clogged.	<ul style="list-style-type: none"> Clean the pump filter.
	Machine has stopped temporarily due to low voltage.	<ul style="list-style-type: none"> Product will resume running when the voltage restores to the normal level.
Product directly drains the water it takes in.	Draining hose is not at adequate height.	<ul style="list-style-type: none"> Connect the water draining hose as described in the user manual.
No water can be seen in the product during washing.	Water is inside the invisible part of the product.	<ul style="list-style-type: none"> This is not a failure.
Loading door cannot be opened.	Loading door lock is activated because of the water level in the product.	<ul style="list-style-type: none"> Drain the water by running the Pump or Spin programme.
	Product is heating up the water or it is at the spinning cycle.	<ul style="list-style-type: none"> Wait until the programme completes.
	Loading door may be stuck because of the pressure it is subjected to.	<ul style="list-style-type: none"> Grab the handle and push and pull the loading door to release and open it.
	If there is no power, loading door of the product will not open.	<ul style="list-style-type: none"> To open the loading door, open the pump filter cap and pull down the emergency handle positioned at the rear side of the said cap. See "Loading door lock"
Washing takes longer than specified in the user manual.(*)	Water pressure is low.	<ul style="list-style-type: none"> Product waits until taking in adequate amount of water to prevent poor washing quality due to the decreased amount of water. Therefore, the washing time extends.
	Voltage is low.	<ul style="list-style-type: none"> Washing time is prolonged to avoid poor washing results when the supply voltage is low.
	Input temperature of water is low.	<ul style="list-style-type: none"> Required time to heat up the water extends in cold seasons. Also, washing time can be lengthened to avoid poor washing results.
	Number of rinses and/or amount of rinse water have increased.	<ul style="list-style-type: none"> Product increases the amount of rinse water when good rinsing is needed and adds an extra rinsing step if necessary.
	Excessive foam has occurred and automatic foam absorption system has been activated due to too much detergent usage.	<ul style="list-style-type: none"> Use recommended amount of detergent.

Problem	Cause	Solution
Programme time does not countdown. (On models with display) (*)	Timer may stop during water intake.	<ul style="list-style-type: none"> • Timer indicator will not countdown until the product takes in adequate amount of water. The product will wait until there is sufficient amount of water to avoid poor washing results due to lack of water. Timer indicator will resume countdown after this.
	Timer may stop during heating step.	<ul style="list-style-type: none"> • Timer indicator will not countdown until the product reaches the selected temperature.
	Timer may stop during spinning step.	<ul style="list-style-type: none"> • Automatic unbalanced load detection system is activated due to the unbalanced distribution of the laundry in the product.
Programme time does not countdown. (*)	There is unbalanced load in the product.	<ul style="list-style-type: none"> • Automatic unbalanced load detection system is activated due to the unbalanced distribution of the laundry in the product.
Product does not switch to spinning step. (*)	There is unbalanced load in the product.	<ul style="list-style-type: none"> • Automatic unbalanced load detection system is activated due to the unbalanced distribution of the laundry in the product.
	The product will not spin if water is not drained completely.	<ul style="list-style-type: none"> • Check the filter and the draining hose.
	Excessive foam has occurred and automatic foam absorption system has been activated due to too much detergent usage.	<ul style="list-style-type: none"> • Use recommended amount of detergent.
Washing performance is poor: Laundry turns gray. (**)	Insufficient amount of detergent has been used over a long period of time.	<ul style="list-style-type: none"> • Use the recommended amount of detergent appropriate for water hardness and the laundry.
	Washing has been made at low temperatures for a long time.	<ul style="list-style-type: none"> • Select the proper temperature for the laundry to be washed.
	Insufficient amount of detergent is used with hard water.	<ul style="list-style-type: none"> • Using insufficient amount of detergent with hard water causes the soil to stick on the cloth and this turns the cloth into gray in time. It is difficult to eliminate graying once it happens. Use the recommended amount of detergent appropriate for water hardness and the laundry.
	Excessive amount of detergent is used.	<ul style="list-style-type: none"> • Use the recommended amount of detergent appropriate for water hardness and the laundry.
Washing performance is poor: Stains persist or the laundry is not whitened. (**)	Insufficient amount of detergent is used.	<ul style="list-style-type: none"> • Use the recommended amount of detergent appropriate for water hardness and the laundry.
	Excessive laundry is loaded in.	<ul style="list-style-type: none"> • Do not load the product in excess. Load with amounts recommended in the "Programme and consumption table".
	Wrong programme and temperature were selected.	<ul style="list-style-type: none"> • Select the proper programme and temperature for the laundry to be washed.
	Wrong type of detergent is used.	<ul style="list-style-type: none"> • Use original detergent appropriate for the product.
	Excessive amount of detergent is used.	<ul style="list-style-type: none"> • Put the detergent in the correct compartment. Do not mix the bleaching agent and the detergent with each other.
Washing performance is poor: Oily stains appeared on the laundry. (**)	Regular drum cleaning is not applied.	<ul style="list-style-type: none"> • Clean the drum regularly. For this procedure, please see "Cleaning the loading door and the drum".
Washing performance is poor: Clothes smell unpleasantly. (**)	Odours and bacteria layers are formed on the drum as a result of continuous washing at lower temperatures and/or in short programmes.	<ul style="list-style-type: none"> • Leave the detergent drawer as well as the loading door of the product ajar after each washing. Thus, a humid environment favorable for bacteria cannot occur in the machine.
Colour of the clothes faded. (**)	Excessive laundry was loaded in.	<ul style="list-style-type: none"> • Do not load the product in excess.
	Detergent in use is damp.	<ul style="list-style-type: none"> • Keep detergents closed in an environment free of humidity and do not expose them to excessive temperatures.
	A higher temperature was selected.	<ul style="list-style-type: none"> • Select the proper programme and temperature according to the type and soiling degree of the laundry.

Problem	Cause	Solution
Washing machine does not rinse well.	The amount, brand and storage conditions of the detergent used are inappropriate.	<ul style="list-style-type: none"> Use a detergent appropriate for the washing machine and your laundry. Keep detergents closed in an environment free of humidity and do not expose them to excessive temperatures.
	Detergent was put in the wrong compartment.	<ul style="list-style-type: none"> If detergent is put in the prewash compartment although prewash cycle is not selected, the product can take this detergent during rinsing or softener step. Put the detergent in the correct compartment.
	Pump filter is clogged.	<ul style="list-style-type: none"> Check the filter.
	Drain hose is folded.	<ul style="list-style-type: none"> Check the drain hose.
Laundry became stiff after washing. (**)	Insufficient amount of detergent is used.	<ul style="list-style-type: none"> Using insufficient amount of detergent for the water hardness can cause the laundry to become stiff in time. Use appropriate amount of detergent according to the water hardness.
	Detergent was put in the wrong compartment.	<ul style="list-style-type: none"> If detergent is put in the prewash compartment although prewash cycle is not selected, the product can take this detergent during rinsing or softener step. Put the detergent in the correct compartment.
	Detergent was mixed with the softener.	<ul style="list-style-type: none"> Do not mix the softener with detergent. Wash and clean the drawer with hot water.
Laundry does not smell like the softener. (**)	Detergent was put in the wrong compartment.	<ul style="list-style-type: none"> If detergent is put in the prewash compartment although prewash cycle is not selected, the product can take this detergent during rinsing or softener step. Wash and clean the drawer with hot water. Put the detergent in the correct compartment.
	Detergent was mixed with the softener.	<ul style="list-style-type: none"> Do not mix the softener with detergent. Wash and clean the drawer with hot water.
Detergent residue in the detergent drawer. (**)	Detergent was put in wet drawer.	<ul style="list-style-type: none"> Dry the detergent drawer before putting in detergent.
	Detergent has gotten damp.	<ul style="list-style-type: none"> Keep detergents closed in an environment free of humidity and do not expose them to excessive temperatures.
	Water pressure is low.	<ul style="list-style-type: none"> Check the water pressure.
	The detergent in the main wash compartment got wet while taking in the prewash water. Holes of the detergent compartment are blocked.	<ul style="list-style-type: none"> Check the holes and clean if they are clogged.
	There is a problem with the detergent drawer valves.	<ul style="list-style-type: none"> Call the Authorised Service Agent.
	Detergent was mixed with the softener.	<ul style="list-style-type: none"> Do not mix the softener with detergent. Wash and clean the drawer with hot water.
	Regular drum cleaning is not applied.	<ul style="list-style-type: none"> Clean the drum regularly. For this procedure, please see "Cleaning the loading door and the drum".
Too much foam forms inside the product. (**)	Improper detergents for the washing machine is used.	<ul style="list-style-type: none"> Use detergents appropriate for the washing machine.
	Excessive amount of detergent is used.	<ul style="list-style-type: none"> Use only sufficient amount of detergent.
	Detergent was stored under improper conditions.	<ul style="list-style-type: none"> Store detergent in a closed and dry location. Do not store in excessively hot places.
	Some meshed laundry such as tulle may foam too much because of their texture.	<ul style="list-style-type: none"> Use smaller amounts of detergent for this type of item.
	Detergent was put in the wrong compartment.	<ul style="list-style-type: none"> Put the detergent in the correct compartment.
Softener is being taken early by the product.	<ul style="list-style-type: none"> There may be problem in the valves or in the detergent drawer. Call the Authorised Service Agent. 	

Problem	Cause	Solution
Foam is overflowing from the detergent drawer.	Too much detergent is used.	<ul style="list-style-type: none"> • Mix 1 tablespoonful softener and ½ l water and pour into the main wash compartment of the detergent drawer.
		<ul style="list-style-type: none"> • Put detergent into the product suitable for the programmes and maximum loads indicated in the "Programme and consumption table". When you use additional chemicals (stain removers, bleaches and etc.), reduce the amount of detergent.
Laundry remains wet at the end of the programme. (*)	Excessive foam has occurred and automatic foam absorption system has been activated due to too much detergent usage.	<ul style="list-style-type: none"> • Use recommended amount of detergent.

(*) The product does not switch to spinning step when the laundry is not evenly distributed in the drum to prevent any damage to the product and to its surrounding environment. Laundry should be rearranged and re-spun.

(**) Regular drum cleaning is not applied. Clean the drum regularly. See 4.4.2



WARNING: If you cannot eliminate the problem although you follow the instructions in this section, consult your dealer or the Authorised Service Agent. Never try to repair a nonfunctional product yourself.



WARNING: Check the HomeWhiz section for the relevant troubleshooting information.

DISCLAIMER / WARNING (EN)

Some (simple) failures can be adequately handled by the end-user without any safety issue or unsafe use arising, provided that they are carried out within the limits and in accordance with the following instructions (see the “Self-Repair” section).

Therefore, unless otherwise authorized in the “Self-Repair” section below, repairs shall be addressed to registered professional repairers in order to avoid safety issues. A registered professional repairer is a professional repairer that has been granted access to the instructions and spare parts list of this product by the manufacturer according to the methods described in legislative acts pursuant to Directive 2009/125/EC.

However, only the service agent (i.e. authorized professional repairers) that you can reach through the phone number given in the user manual/warranty card or through your authorized dealer may provide service under the guarantee terms. Therefore, please be advised that repairs by professional repairers (who are not authorized by Grundig) shall void the guarantee.

Self-Repair

Self-repair can be done by the end-user with regard to the following spare parts: door, door hinge and seals, other seals, door locking assembly and plastic peripherals such as detergent dispensers (an updated list is also available in support.grundig.com as of 1st of March 2021).

Moreover, to ensure product safety and to prevent risk of serious injury, the mentioned self-repair shall be done following the instructions in the user manual for self-repair or which are available in support.grundig.com. For your safety, unplug the product before attempting any self-repair.

Repair and repair attempts by end-users for parts not included in such list and/or not following the instructions in the user manuals for self-repair or which are available in support.grundig.com, might give raise to safety issues not attributable to Grundig, and will void the warranty of the product.

Therefore, it is highly recommended that end-users refrain from the attempt to carry out repairs falling outside the mentioned list of spare parts, contacting in such cases authorized professional repairers or registered professional repairers. On the contrary, such attempts by end-users may cause safety issues and damage the product and subsequently cause fire, flood, electrocution and serious personal injury to occur.

By way of example, but not limited to, the following repairs must be addressed to authorized professional repairers or registered professional repairers: motor, pump assembly, main board, motor board, display board, heaters etc.

The manufacturer/seller cannot be held liable in any case where end-users do not comply with the above.

The spare part availability of the washing machine or washer-dryer that you purchased is 10 years. During this period, original spare parts will be available to operate the washing machine or washer-dryer properly.

